



NEWMAX CORP.

Quality You Can Trust !



We Deal in all Kind of Surgical & Dental Instruments.



www.newmax.pk

Table of Contents















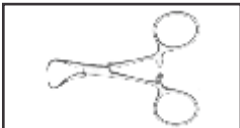
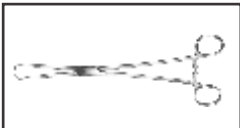



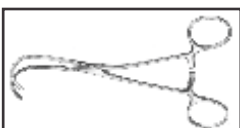
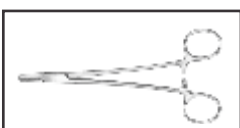
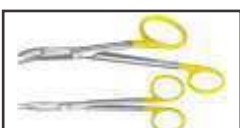



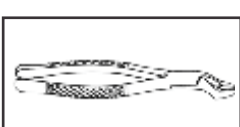

01S		DIAGNOSTIC INSTRUMENTS	10S		NEURO SURGERY INSTRUMENTS
	PAGE 1 TO 3			PAGE 52 TO 57	
02S		HEMOSTATIC INSTRUMENTS	11S		BONE SURGERY INSTRUMENTS
	PAGE 4 TO 11			PAGE 58 TO 73	
03S		TOWEL CLAMPS	12S		GYNECOLOGICAL & OBSTETRICAL INSTRUMENTS
	PAGE 12			PAGE 74 TO 84	
04S		SCISSORS	13S		EYE INSTRUMENTS
	PAGE 13 TO 17			PAGE 85 TO 94	
05S		DRESSING & TISSUE FORCEPS	14S		ATRAUMATIC INSTRUMENTS
	PAGE 18 TO 22			PAGE 95 TO 96	
06S		NEEDLE HOLDER	15S		TONGSTEN CARBIDE INSTRUMENTS (T.C)
	PAGE 23 TO 25			PAGE 97 TO 107	
07S		RETRACTORS	16S		LASER SURGERY INSTRUMENTS
	PAGE 26 TO 34			PAGE 108 TO 111	
08S		ORAL INSTRUMENTS	17S		HOLLOWARE
	PAGE 35 TO 37			PAGE 112 TO 114	
09S		E.N.T INSTRUMENTS	01D		EXTRACTING FORCEPS
	PAGE 38 TO 51			PAGE 115 TO 117	

Table of Contents

02D	 PAGE 118 TO 121	ELEVATORS	01E	 142 TO 145	E.M.S
03D	 PAGE 122	MIRROR + HANDLE	01V	 PAGE 146 TO 148	VETERINARY INSTRUMENTS
04D	 PAGE 123 TO 124	AMALGAM CARRIERS & SYRINGES		 PAGE 149	DIAGNOSTIC INSTRUMENTS
05D	 PAGE 125	MISCELLANEOUS			
06D	 PAGE 126	TUFFLIMIRE, CALIPERS ETC			
07D	 PAGE 127 TO 135	GENERAL DENTISTRY INSTRUMENTS			
08D	 PAGE 136 TO 137	RUBBER DAM FORCEPS & CLAMPS			
09D	 PAGE 138 TO 139	PLIERS			
10D	 140 TO 141	IMPRESSION TRAY			

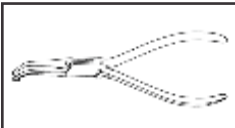
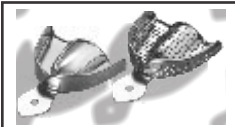
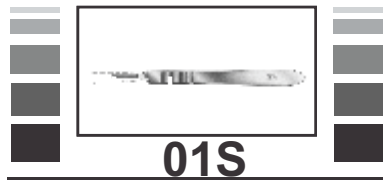

DIAGNOSTIC INSTRUMENTS

Box of 100 Pcs



(Fits handles # 3, 3L, 3LA, 7, 9,)

01S-001 01S-002 01S-003 01S-004 01S-005 01S-006

Carbon Steel Sterile Surgical Blades

Box of 100 Pcs

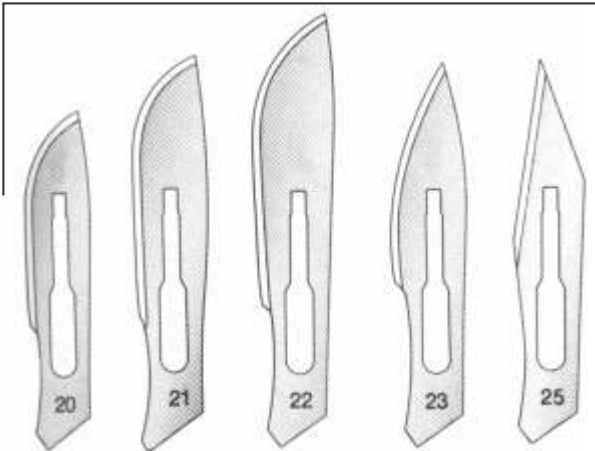

(Fits handles # 4, 4L,)

01S-007 01S-008 01S-009 01S-010 01S-011

Carbon Steel Sterile Surgical Blades

Scalpel Handles

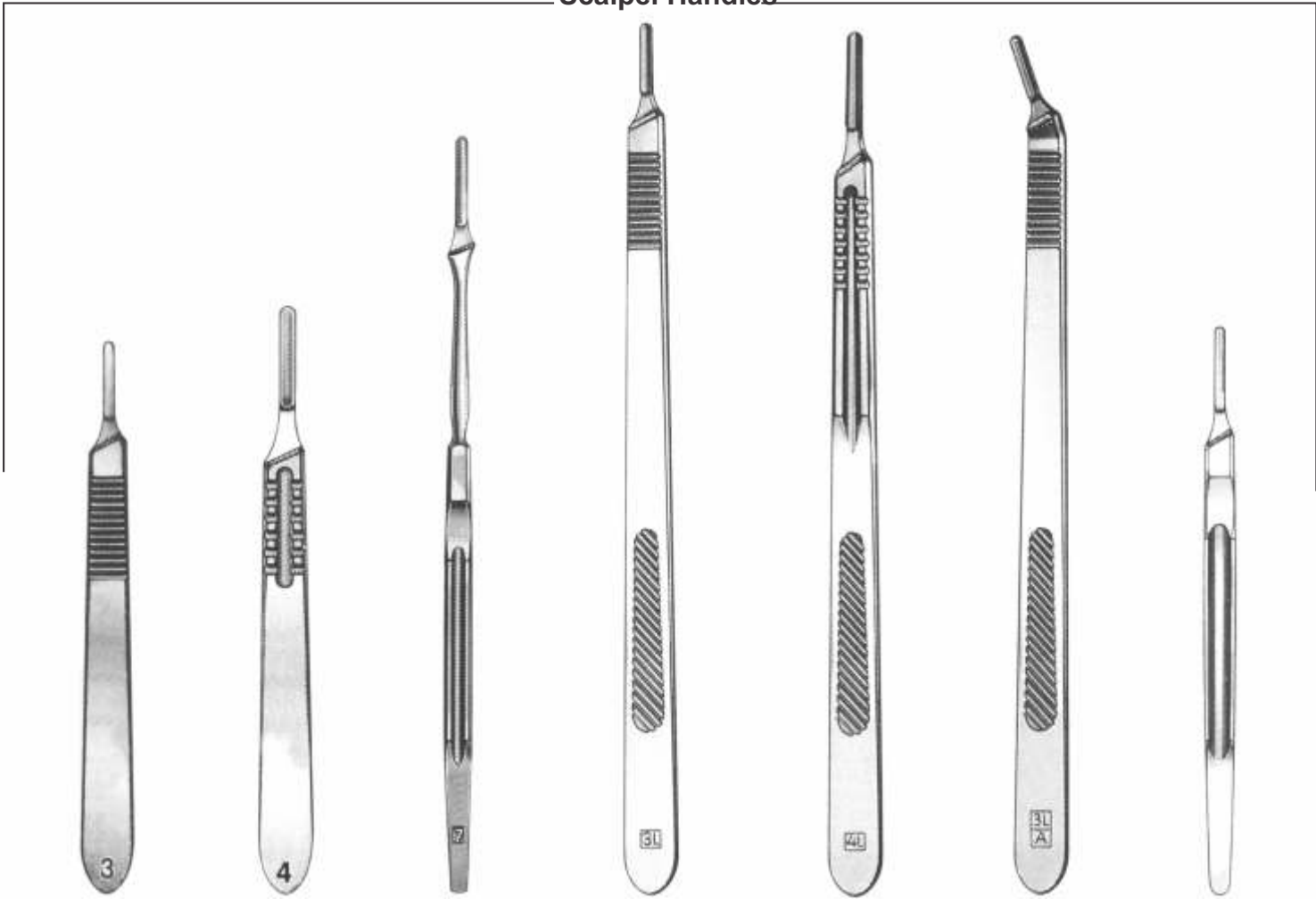

#3

01S5-012

#4

01S-013

#7

01S-014

#3L

01S-015

#4L

01S-016

#3LA

01S-017

#9

01S-018

DIAGNOSTIC INSTRUMENTS



NEWMAX CORPORATION

01S

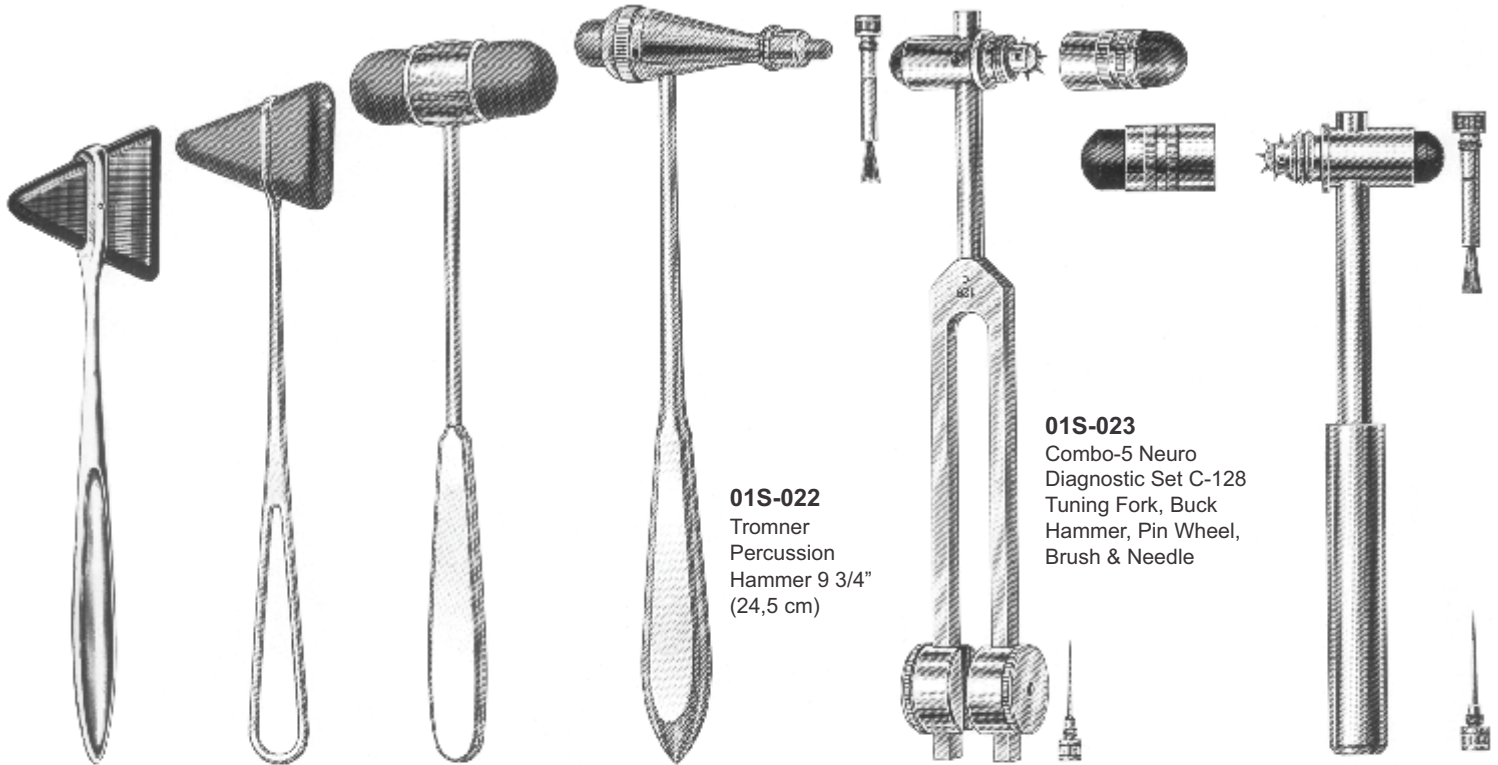

01S-019

Taylor Percussion Hammer
7 1/2" (19 cm)

01S-020

Taylor Percussion Hammer
9" (22 cm)

01S-021

Dejerine Percussion Hammer
9 1/2" (24 cm)

01S-022

Tromner Percussion Hammer 9 3/4" (24,5 cm)

01S-023

Combo-5 Neuro Diagnostic Set C-128
Tuning Fork, Buck Hammer, Pin Wheel, Brush & Needle

01S-024

Combo-4 Neuro Diagnostic Set Buck Hammer, Pin Wheel, Brush & Needle

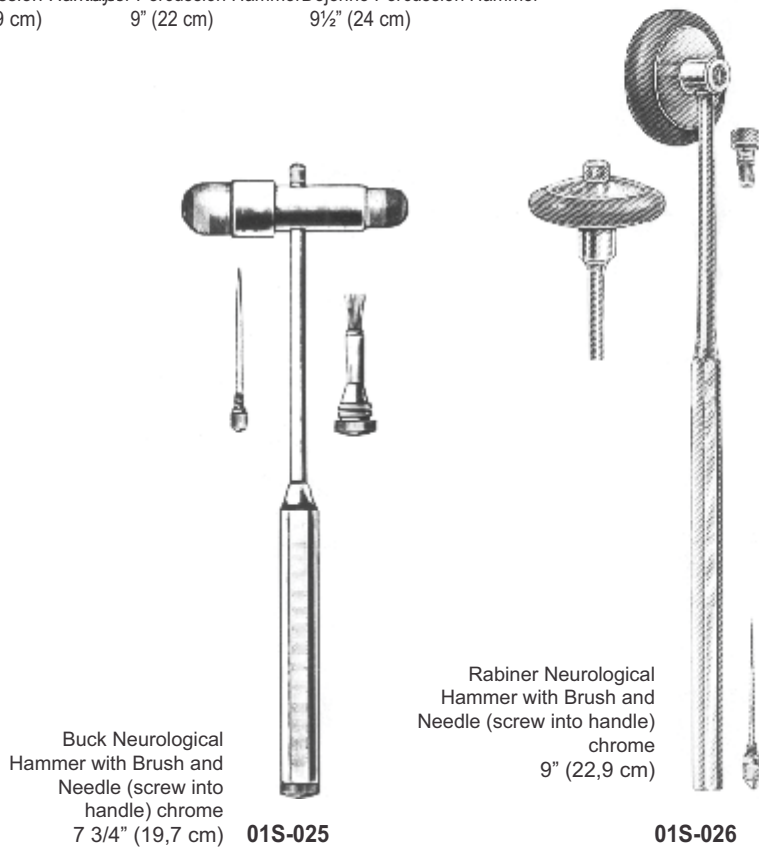

Buck Neurological Hammer with Brush and Needle (screw into handle) chrome
7 3/4" (19,7 cm)

01S-025

Rabiner Neurological Hammer with Brush and Needle (screw into handle) chrome
9" (22,9 cm)

01S-026

01S-027
Wartenberg Neurological Pin Wheel
7" (17,8 cm)

DIAGNOSTIC INSTRUMENTS

01S



Probes, Double End

ARTICLE #	SIZE
01S-028	4 1/2" (11,4 cm)
01S-029	5" (12,7 cm)
01S-030	5 1/2" (14 cm)
01S-031	6" (15,2 cm)
01S-032	7" (17,8 cm)
01S-033	8" (20,3 cm)
01S-034	10" (25,4 cm)



Probes, With Eye

ARTICLE #	SIZE
01S-035	4 1/2" (11,4 cm)
01S-036	5" (12,7 cm)
01S-037	5 1/2" (14 cm) 6"
01S-038	(15,2 cm) 7"
01S-039	(17,8 cm) 8"
01S-040	(20,3 cm) 10"
01S-041	(25,4 cm)



01S-042
Probe with Myrtle Leaf 5" (12,7 cm)



Grooved Directors With Tongue Tie

ARTICLE #	SIZE
01S-043	4 1/2" (11,4 cm)
01S-044	5" (12,7 cm)
01S-045	5 1/2" (14 cm)
01S-046	6" (15,2 cm)
01S-047	8" (20,3 cm)



Grooved Directors With Probe Tip & Tongue Tie

ARTICLE #	SIZE
01S-048	4 1/2" (11,4 cm)
01S-049	5" (12,7 cm)
01S-050	5 1/2" (14 cm)
01S-051	6" (15,2 cm)
01S-052	8" (20,3 cm)



01S-053
Larry Probe and Grooved Director 7" (17,8 cm)



01S-054

Pinard Fetal Head Stethoscope (Aluminum)

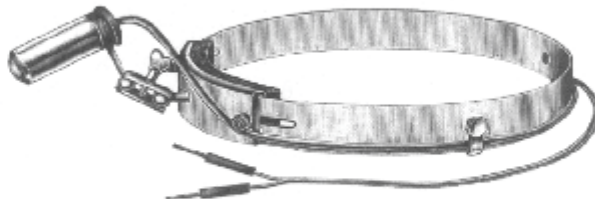

01S-055
Head Light



01S-056
Mirror Head

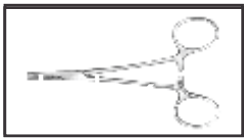

02S

HEMOSTATIC INSTRUMENTS

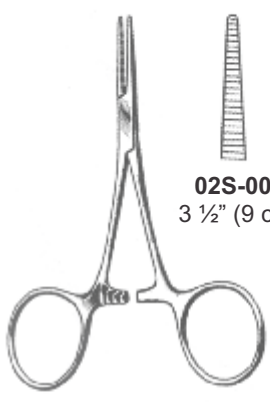

02S-001 3 1/2" (9 cm)
02S-002 3 1/2" (9 cm)

Baby-Mosquito Forceps (HARTMANN)

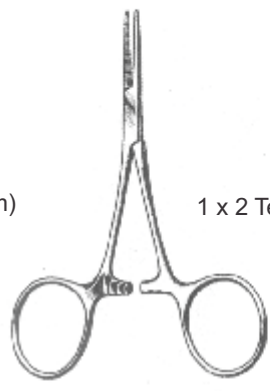

02S-003 3 1/2" (10 cm)
02S-004 3 1/2" (10 cm)
02S-005 3 1/2" (10 cm)
02S-006 3 1/2" (10 cm)

Micro-Mosquito Forceps

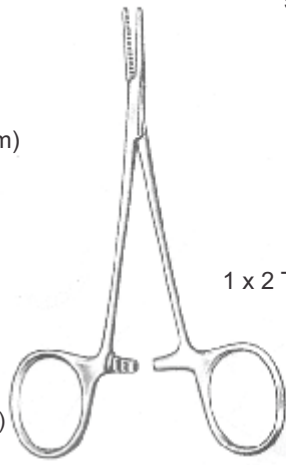

02S-007 5" (12 cm)
02S-008 5" (12 cm)
02S-009 5" (12 cm)
02S-010 5" (12 cm)

Micro-Halstead-Mosquito Forceps

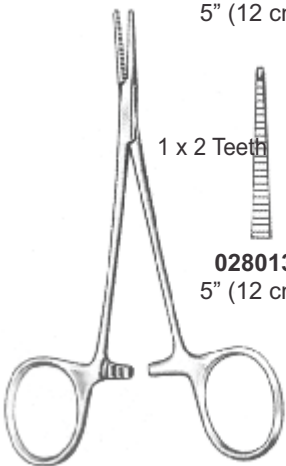

02S-011 5" (12 cm)
02S-012 5" (12 cm)
028013 5" (12 cm)
02S-014 5" (12 cm)

Halstead-Mosquito Forceps

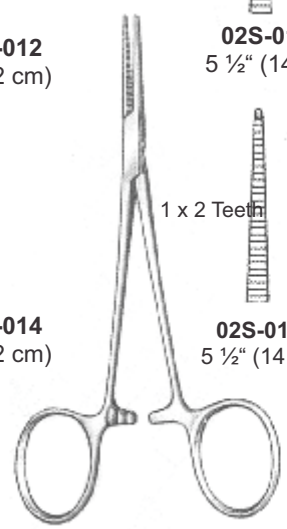

02S-015 5 1/2" (14 cm)
02S-016 5 1/2" (14 cm)
02S-017 5 1/2" (14 cm)
02S-018 5 1/2" (14 cm)

Halstead-Mosquito Forceps

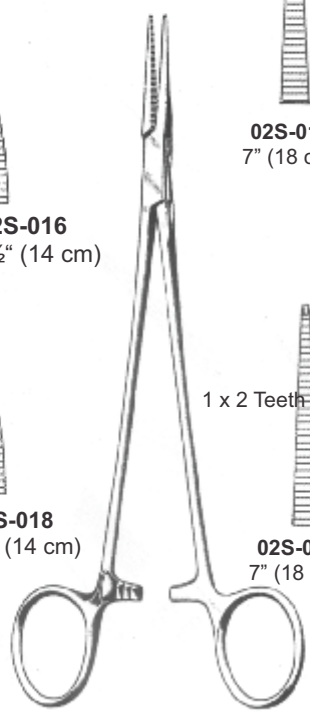

02S-019 7" (18 cm)
02S-020 8" (20 cm)
02S-021 7" (18 cm)
02S-022 8" (20 cm)
02S-023 7" (18 cm)
02S-024 8" (20 cm)
02S-025 7" (18 cm)
02S-026 8" (20 cm)

Halstead-Mosquito Forceps

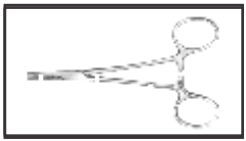

02S

HEMOSTATIC INSTRUMENTS



NEWMAX CORPORATION



Kelly Hemostatic Forceps



02S-027
5 1/2" (14 cm)



02S-028
5 1/2" (14 cm)

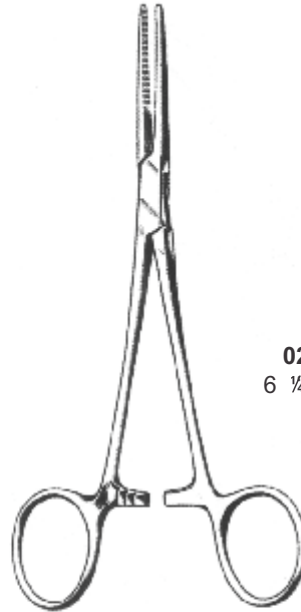

Kelly-Rankin Hemostatic Forceps



02S-029
6 1/4" (16 cm)



02S-030
6 1/4" (16 cm)

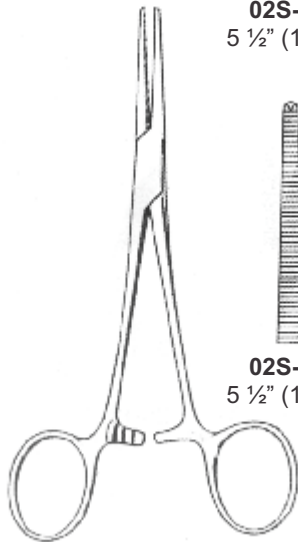

Crile-Hemostatic Forceps



02S-031
5 1/2" (14 cm)



02S-032
5 1/2" (14 cm)



02S-033
5 1/2" (14 cm)



02S-034
5 1/2" (14 cm)

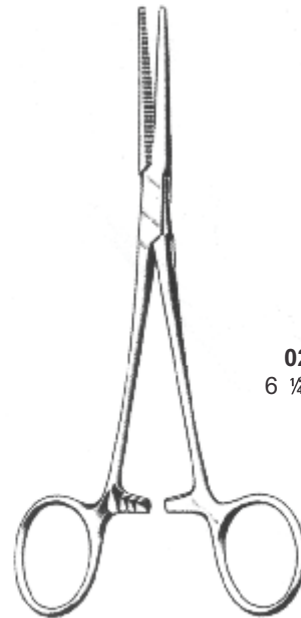

Crile-Rankin Hemostatic Forceps



02S-035
6 1/4" (16 cm)



02S-036
6 1/4" (16 cm)

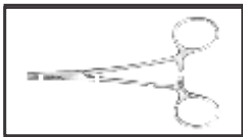

02S

HEMOSTATIC INSTRUMENTS



NEWMAX CORPORATION



Kocher Hemostatic Forceps 1 x 2 Teeth



Rochester Pean Forceps Serrated

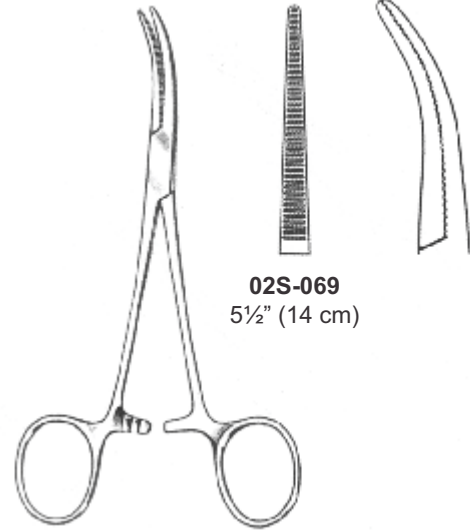

02S-069
5½" (14 cm)

Dandy Hemostatic Forceps

ARTICLE # Straight	Size	ARTICLE # Curved
02S-037	5 ½" (14 cm)	02S-045
02S-038	6 ¼" (16 cm)	02S-046
02S-039	7" (18 cm)	02S-047
02S-040	8" (20 cm)	02S-048
02S-041	8 ¾" (22 cm)	02S-049
02S-042	9 ½" (24 cm)	02S-050
02S-043	10 ¼" (26 cm)	02S-051
02S-044	12" (30 cm)	02S-052

ARTICLE # Straight	Size	ARTICLE # Curved
02S-053	5 ½" (14 cm)	02S-061
02S-054	6 ¼" (16 cm)	02S-062
02S-055	7" (18 cm)	02S-063
02S-056	8" (20 cm)	02S-064
02S-057	8 ¾" (22 cm)	02S-065
02S-058	9 ½" (24 cm)	02S-066
02S-059	10 ¼" (26 cm)	02S-067
02S-060	12" (30 cm)	02S-068

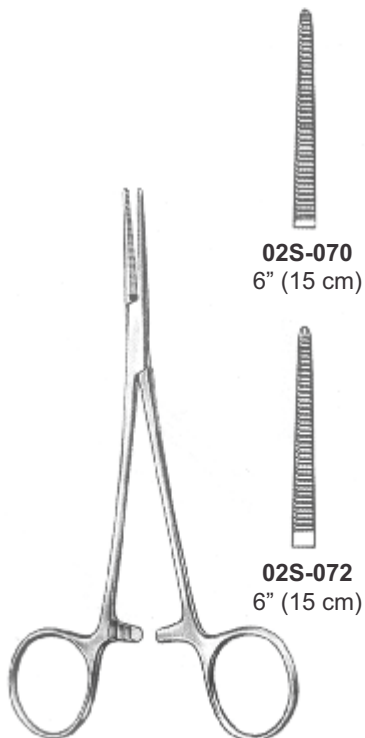

Leriche Hemostatic Forceps



02S-072
6" (15 cm)

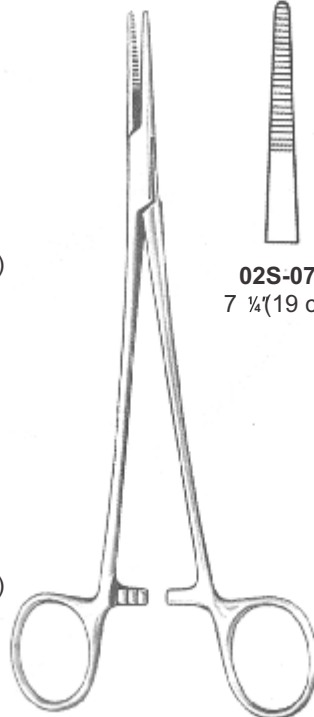

Adson Hemostatic Forceps

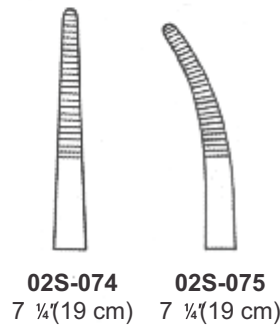

02S-071
6" (15 cm)

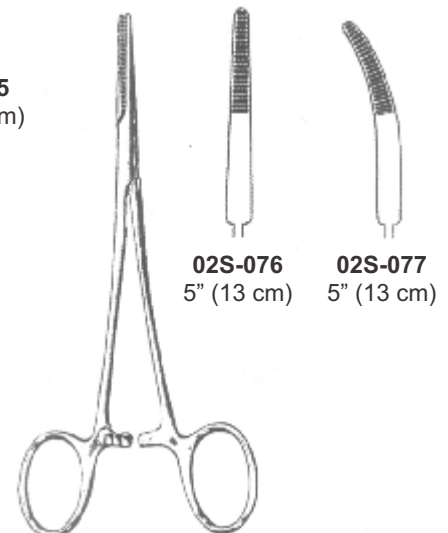

Providence-Hospital
Hemostatic Forceps

02S-074
7 ¼" (19 cm)

02S-075
7 ¼" (19 cm)

02S-076
5" (13 cm)

02S-077
5" (13 cm)

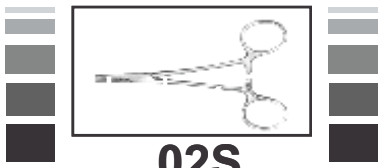

HEMOSTATIC INSTRUMENTS

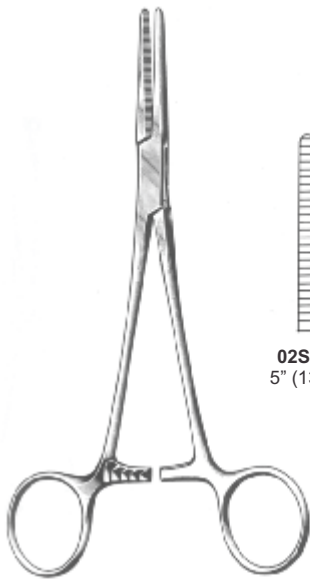

Spencer-Wells Artery Forceps

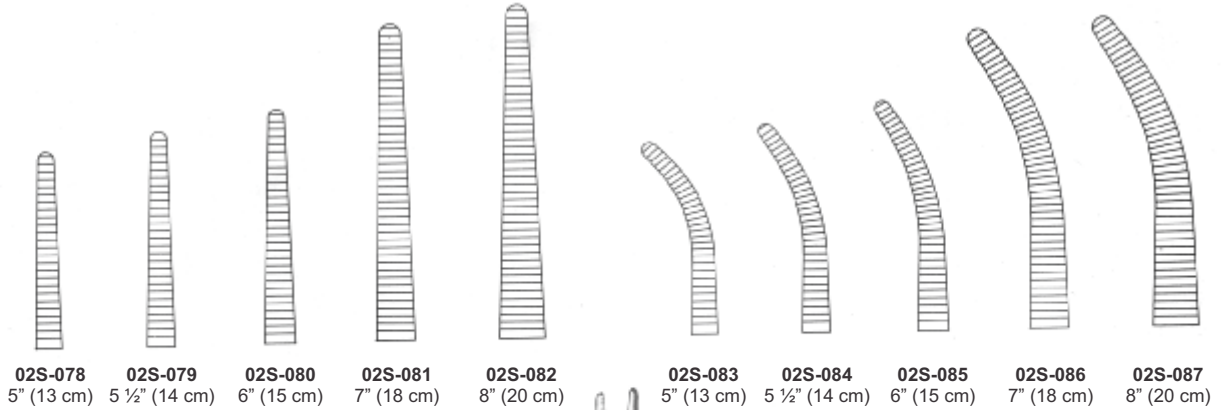

Rochester-Carmalt Forceps

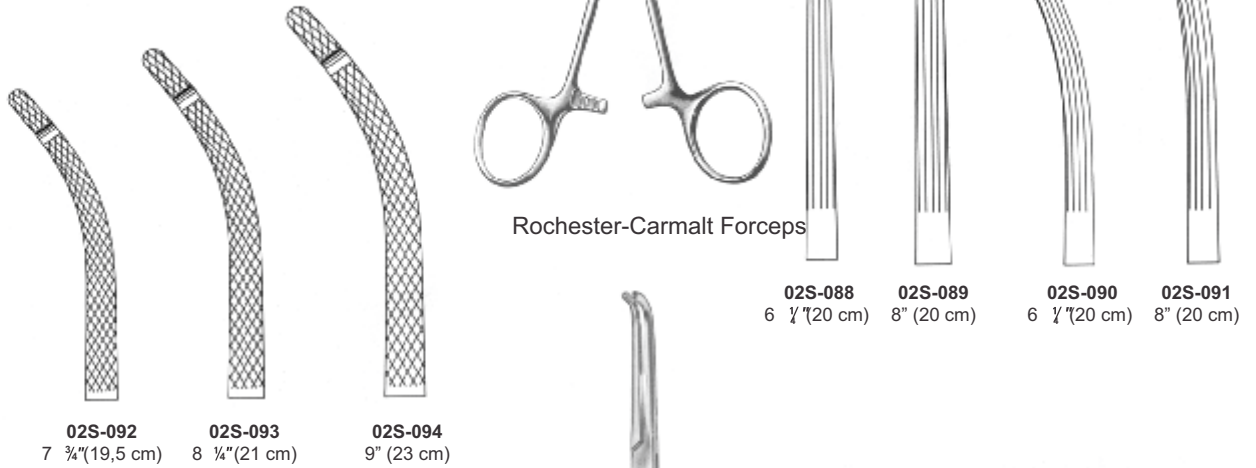

Heaney Hemostatic Forceps

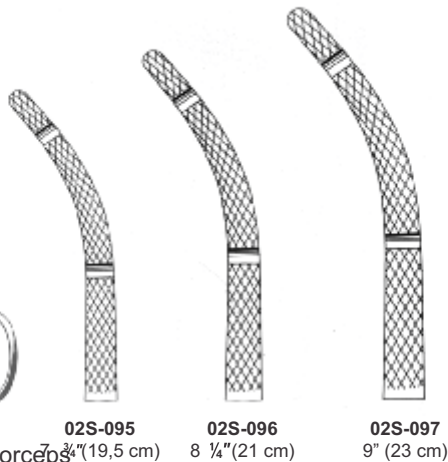

Mixer Artery Forceps

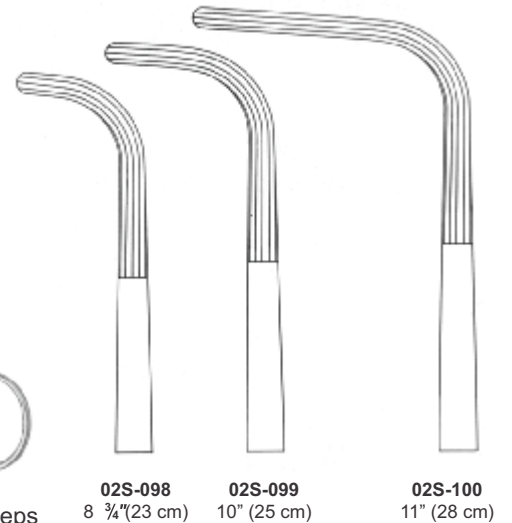

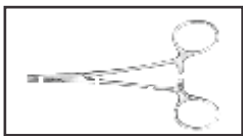
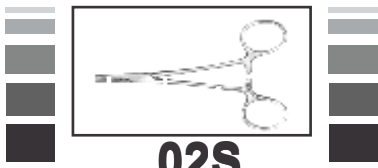

02S

HEMOSTATIC INSTRUMENTS

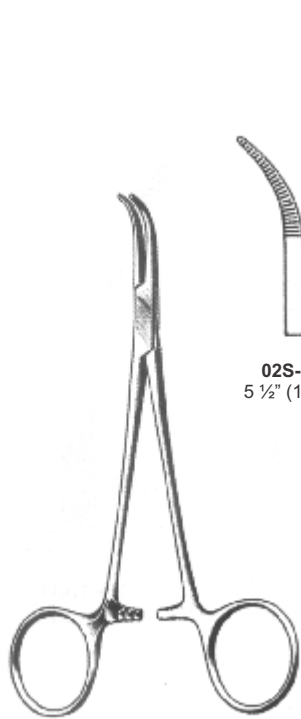

Baby-Mixer Forceps



02S-101
5 1/2" (14 cm)



02S-102
5 1/2" (14 cm)



Baby-Mixer Forceps



02S-103
5 1/2" (14 cm)



Baby-Mixer Forceps



02S-104
7" (18 cm)



02S-105
Mixer Oschner Artery
Forceps
7 1/2" (19 cm)

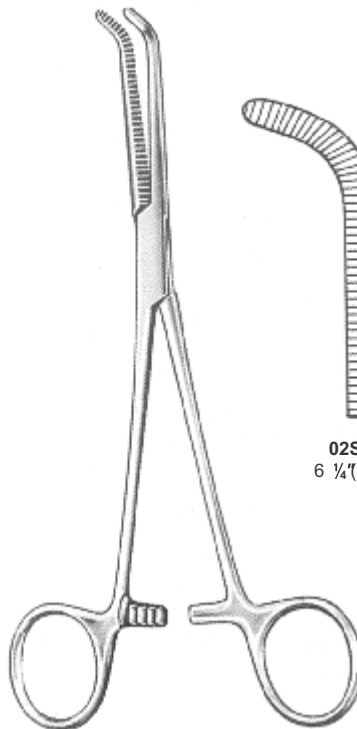

Mixer Artery Forceps

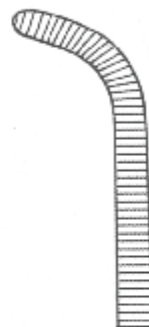

02S-106
6 1/4" (19 cm)

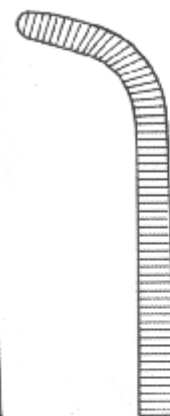

02S-107
7 1/2" (19,5 cm)

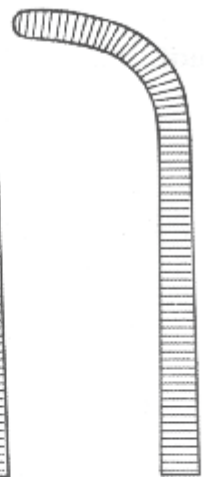

02S-108
8 1/2" (21,5 cm)

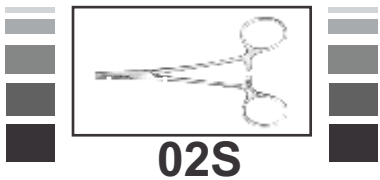

HEMOSTATIC INSTRUMENTS

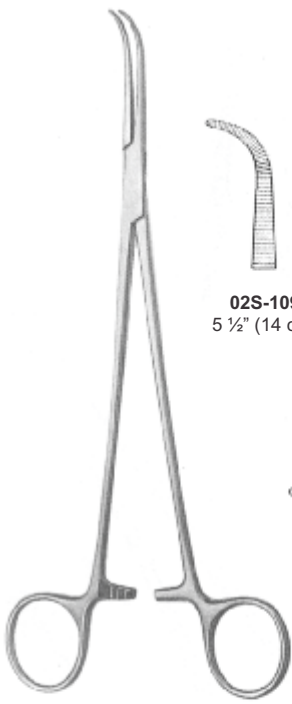

Gemini Hemostatic Forceps

- 02S-109**
5 1/2" (14 cm)
- 02S-110**
6 1/4" (16 cm)
- 02S-111**
7" (18 cm)
- 02S-112**
8" (20 cm)

- 02S-113**
9" (23 cm)
- 02S-114**
10" (25 cm)
- 02S-114**
11" (28 cm)

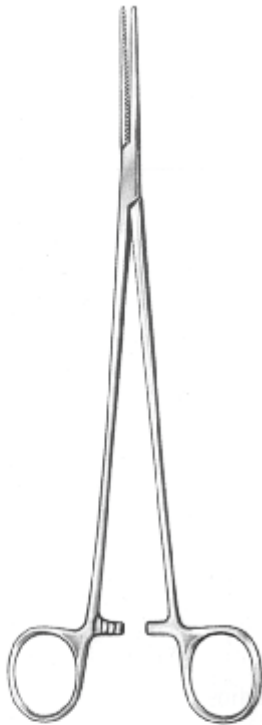

Bangolea Hemostatic Forceps

- 02S-116**
9 1/2" (24 cm)
- 02S-117**
10 1/4" (26 cm)
- 02S-118**
9 1/2" (24 cm)
- 02S-119**
10 1/4" (26 cm)

- 02S-120**
9 1/2" (24 cm)
- 02S-121**
10 1/4" (26 cm)
- 02S-122**
9 1/2" (24 cm)
- 02S-123**
10 1/4" (26 cm)



02S-124
Baby-Mikulicz
Peritoneal Clamp
Forceps
5 1/2" (14 cm)

1 x 2 Teeth



02S-125
Mikulicz
Peritoneal
Clamp
Forceps
8" (20,5 cm)

1 x 2 Teeth

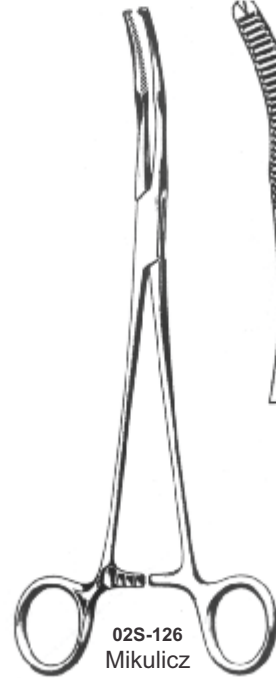

02S-126
Mikulicz
Peritoneal
Clamp
Forceps
8 1/2" (21,5 cm)

1 x 2 Teeth

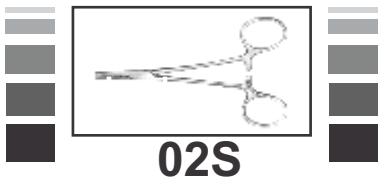

HEMOSTATIC INSTRUMENTS



2x3 Teeth 3x4 Teeth 4x5 Teeth 4x5 Teeth 5x6 Teeth 6x7 Teeth

SIZE	Allis	Judd-Allis	Baby-Allis	Allis	Allis	Thomas-Allis
5" (13 cm)	02S-127	02S-132	02S-137	02S-142	02S-147	02S-152
6" (15 cm)	02S-128	02S-133	02S-138	02S-143	02S-148	02S-153
7 1/2" (19 cm)	02S-129	02S-134	02S-139	02S-144	02S-149	02S-154
8" (20 cm)	02S-130	02S-135	02S-140	02S-145	02S-150	02S-155
10" (25 cm)	02S-131	02S-136	02S-141	02S-146	02S-151	02S-156

ARTICLE #	SIZE
02S-157	5.5" (14,5 cm)
02S-158	6.5" (16 cm)
02S-159	7" (18 cm)
02S-160	8.5" (21 cm)
02S-161	9.5" (24 cm)

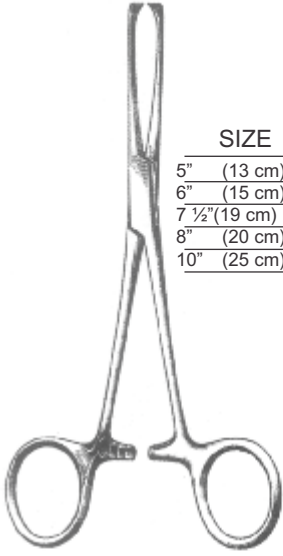

Allis Forceps

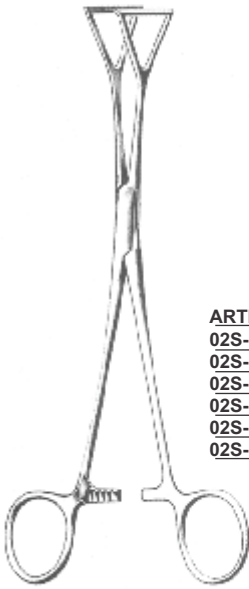

Duval Forceps



ARTICLE #	A (mm)	SIZE
02S-164	14 mm	8" (20 cm)
02S-165	18 mm	8" (20 cm)
02S-166	28 mm	8" (20 cm)
02S-167	14 mm	9" (23 cm)
02S-168	18 mm	9" (23 cm)
02S-169	28 mm	9" (23 cm)

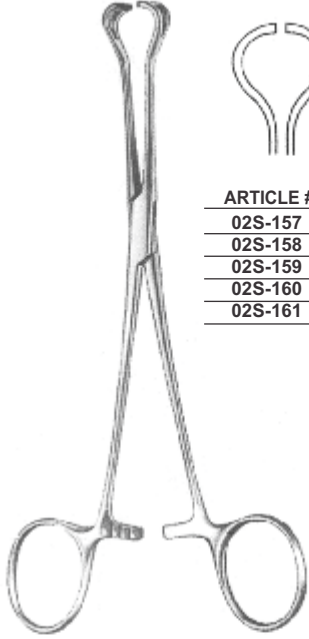

Babcock Forceps

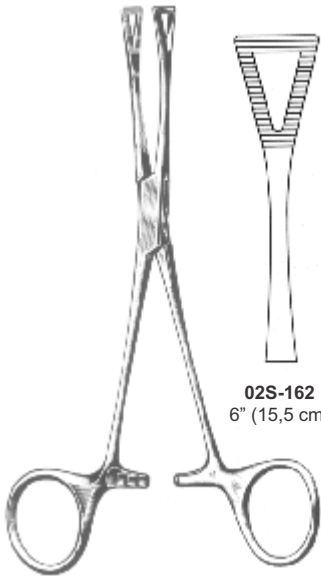

Pennington Forceps

02S-162
6" (15,5 cm)



02S-162
8" (20 cm)

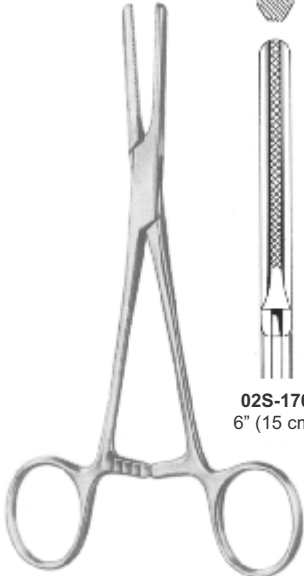

Tube Occluding Forceps



02S-170
6" (15 cm)



02S-171
7" (18 cm)

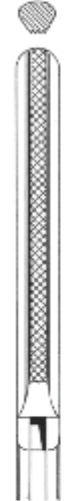

02S-172
8" (20 cm)



Tube Forceps

ARTICLE #	SIZE
02S-173	5 1/2" (14 cm)
02S-174	6 1/2" (16,5 cm)
02S-175	7 1/4" (18 cm)

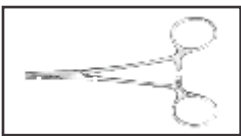

02S

HEMOSTATIC INSTRUMENTS



NEWMAX CORPORATION

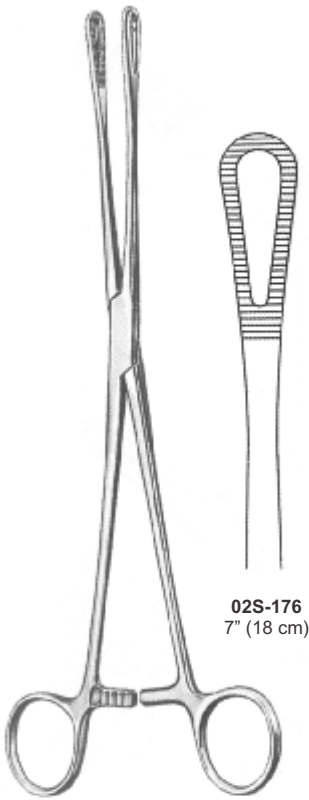

02S-176
7" (18 cm)

Ramsey Spong Forceps



02S-177
10" (25 cm)

Gross-Maier Dressing Forceps

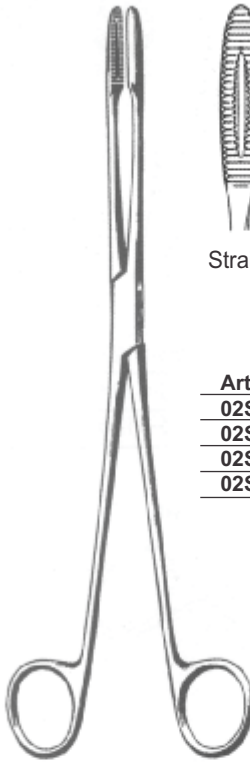

Straight

Curved

Article #	Size
02S-178	8" (20 cm)
02S-179	9" (23 cm)
02S-180	10" (25 cm)
02S-181	10 1/2" (27 cm)

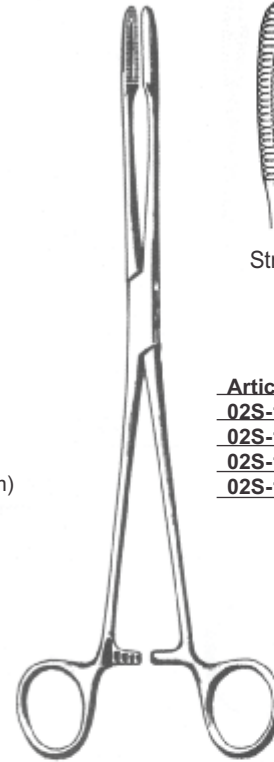

Straight

Curved

Article #	Size
02S-182	8" (20 cm)
02S-183	9" (23 cm)
02S-184	10" (25 cm)
02S-185	10 1/2" (27 cm)

Gross-Maier Dressing Forceps

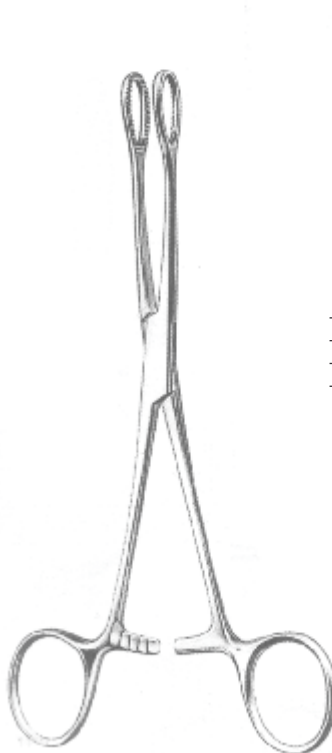

Foerster Spong Forceps

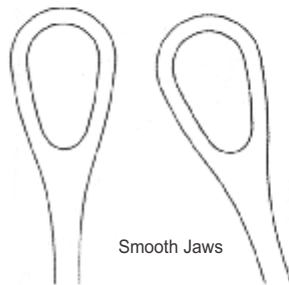

Smooth Jaws

Article #	Size	Article #	Size
02S-186	7" (18 cm)	02S-189	7" (18 cm)
02S-187	8" (20 cm)	02S-190	8" (20 cm)
02S-188	10" (25 cm)	02S-191	10" (25 cm)

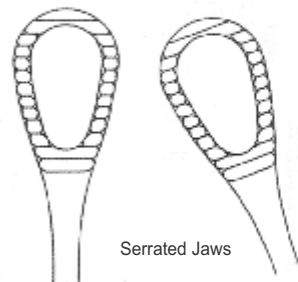

Serrated Jaws

Article #	Size	Article #	Size
02S-192	7" (18 cm)	02S-195	7" (18 cm)
02S-193	8" (20 cm)	02S-196	8" (20 cm)
02S-194	10" (25 cm)	02S-197	10" (25 cm)

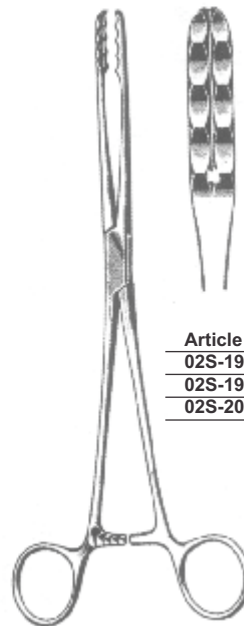

Ulrich Cotton Swab Forceps

Article #	Size
02S-198	9" (23 cm)
02S-199	10" (25 cm)
02S-200	10 1/2" (27 cm)

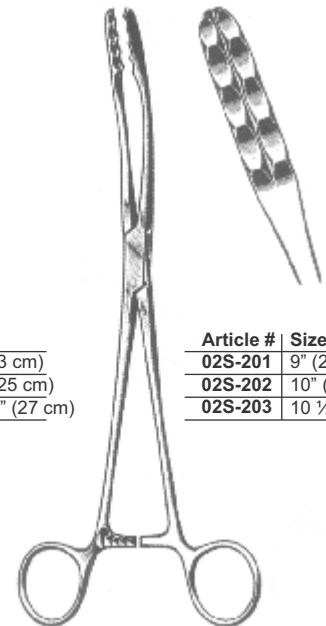

Ulrich Cotton Swab Forceps

Article #	Size
02S-201	9" (23 cm)
02S-202	10" (25 cm)
02S-203	10 1/2" (27 cm)

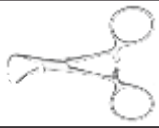

03S

TOWEL CLAMPS



NEWMAX CORPORATION

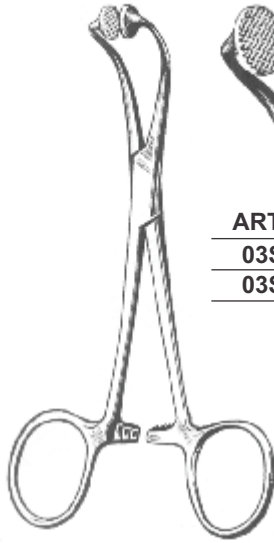

Hoff Towel Clamp
Stainless Steel

ARTICLE #	SIZE
03S-001	4" (10 cm)
03S-002	5 3/4" (14.5 cm)



03S-003
Roeder Towel Clamp with Ball Stop
5" (13 cm)



03S-004
Jones Towel Clamp
3 1/2" (9 cm)

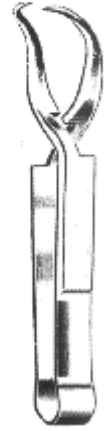

03S-005
Schaedel Towel Clamp
3 1/2" (9 cm)



Ball & Socket Towel Clamp

ARTICLE #	SIZE
03S-006	3 3/4" (10 cm)
03S-007	5 1/2" (14 cm)
03S-008	6" (15 cm)



Lorna Towel Clamp

ARTICLE #	SIZE
03S-009	4" (10 cm)
03S-010	5" (13 cm)

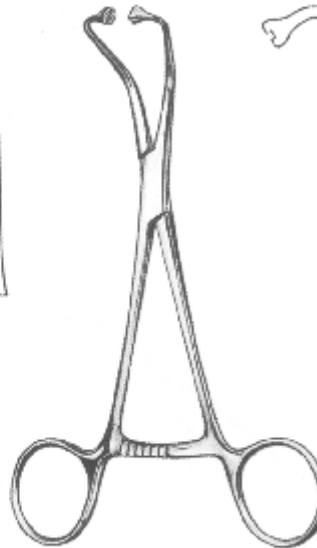

03S-011
Peers Towel Clamp 5"
(14.5 cm)

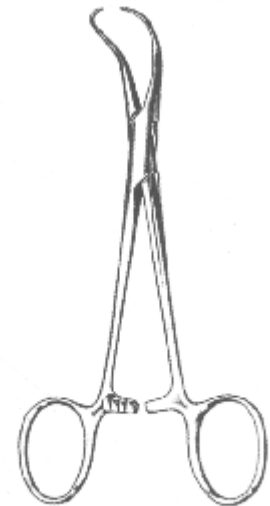

Backhaus Towel Clamp

ARTICLE #	SIZE
03S-012	3.5" (9 cm)
03S-013	4 1/2" (11 cm)
03S-014	5" (13 cm)
03S-015	6" (15 cm)

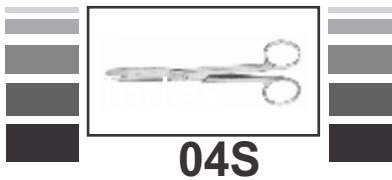

04S

SCISSORS

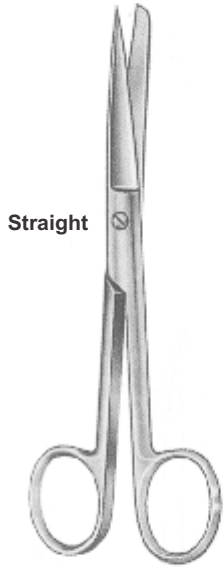

Straight

Operating Scissors

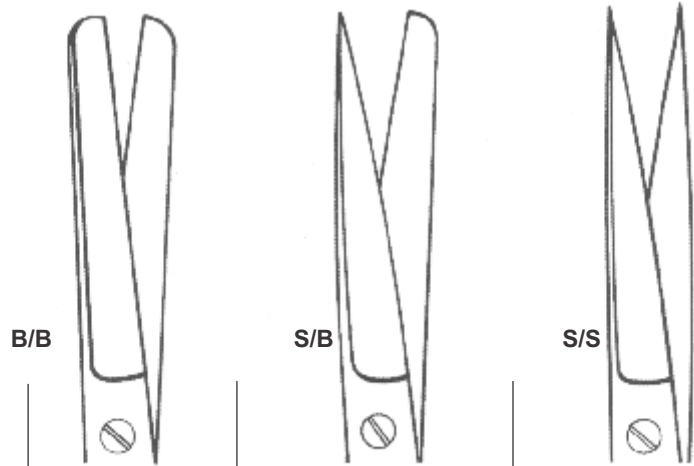

SIZE	B/B	S/B	S/S
4¼" (10.5 cm)	04S-001	04S-010	04S-019
4¾" (11.5 cm)	04S-002	04S-011	04S-020
5" (13.0 cm)	04S-003	04S-012	04S-021
5½" (14.5 cm)	04S-004	04S-013	04S-022
6" (15.5 cm)	04S-005	04S-014	04S-023
6 ½" (16.5 cm)	04S-006	04S-015	04S-024
7" (17.5 cm)	04S-007	04S-016	04S-025
7¼" (18.5 cm)	04S-008	04S-017	04S-026
8" (20.0 cm)	04S-009	04S-018	04S-027

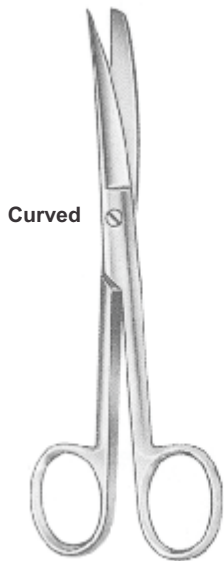

Curved

Operating Scissors

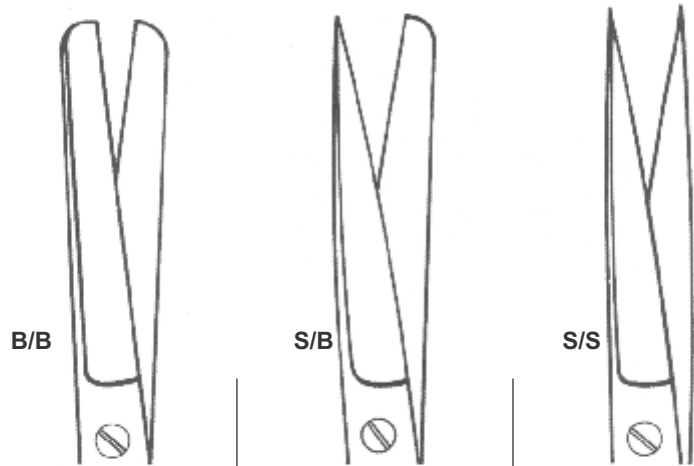

SIZE	B/B	S/B	S/S
4¼" (10.5 cm)	04S-028	04S-037	04S-046
4¾" (11.5 cm)	04S-029	04S-038	04S-047
5" (13.0 cm)	04S-030	04S-039	04S-048
5½" (14.5 cm)	04S-031	04S-040	04S-049
6" (15.5 cm)	04S-032	04S-041	04S-050
6 ½" (16.5 cm)	04S-033	04S-042	04S-051
7" (17.5 cm)	04S-034	04S-043	04S-052
7¼" (18.5 cm)	04S-035	04S-044	04S-053
8" (20.0 cm)	04S-036	04S-045	04S-054

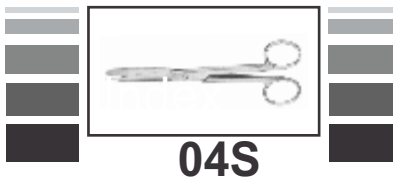

04S

SCISSORS

Straight

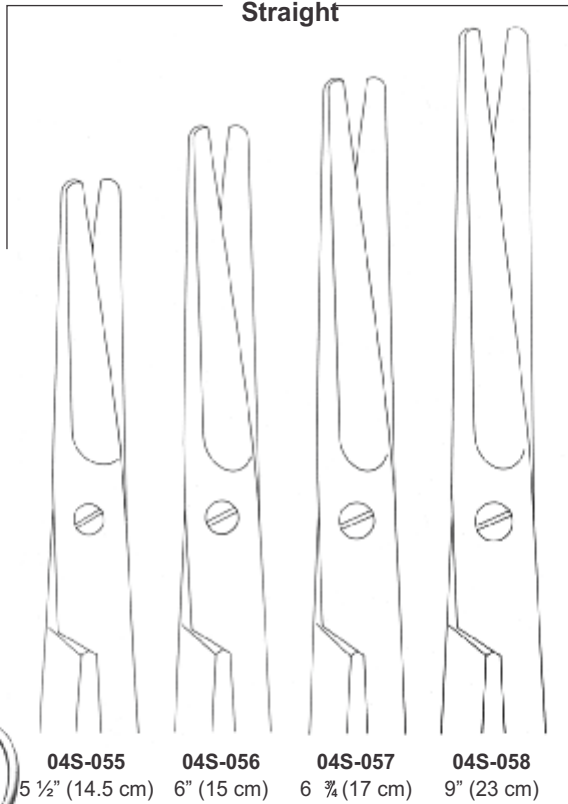

Curved

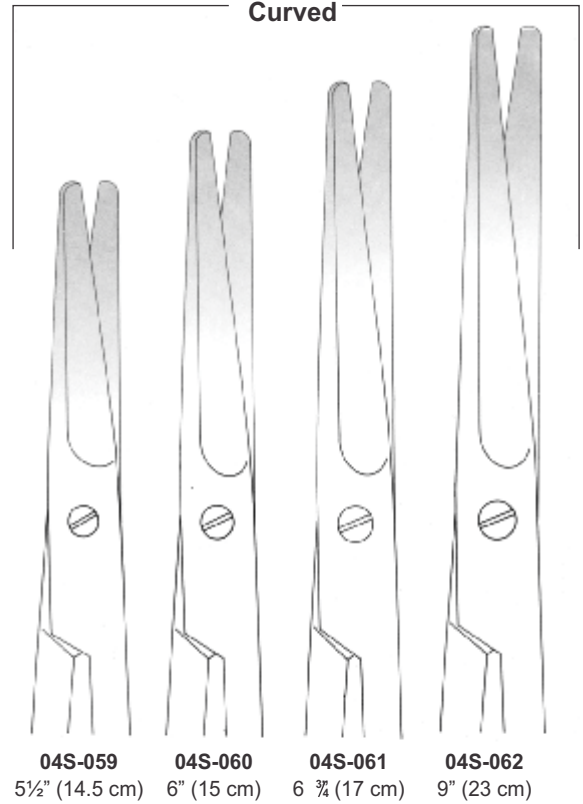

Mayo Dressing Scissors

Straight

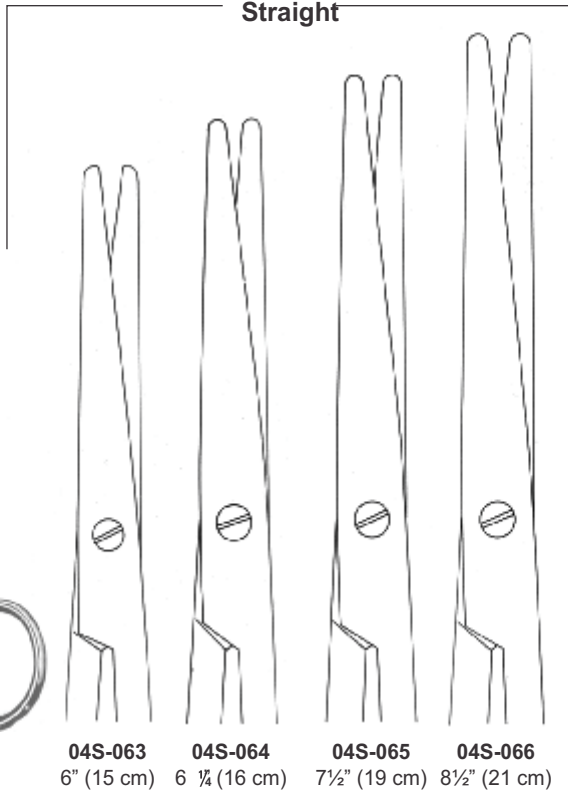
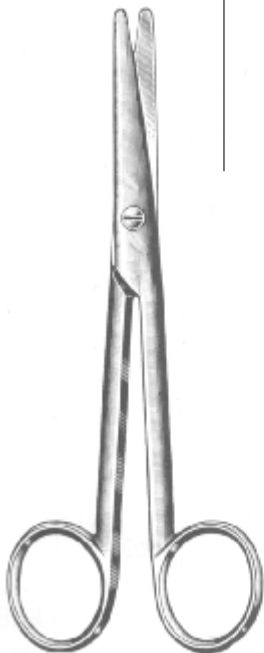

Curved

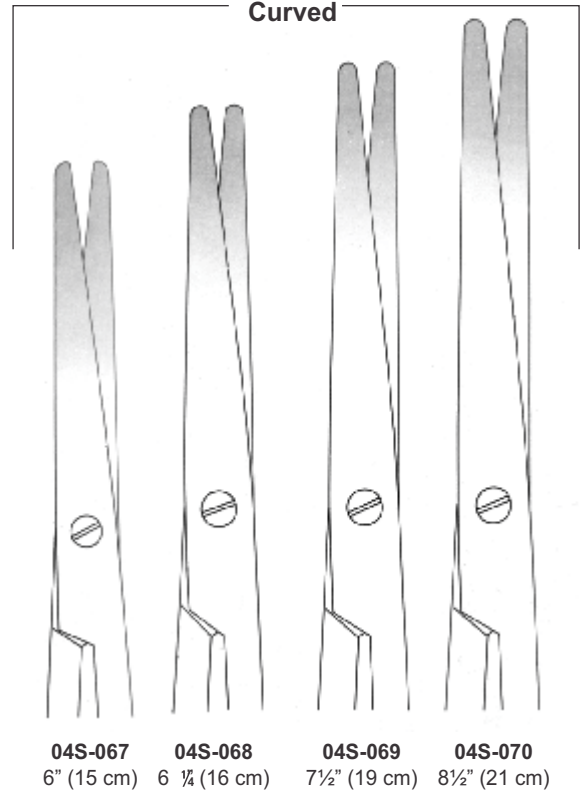

Mayo-Stillle Dressing Scissors

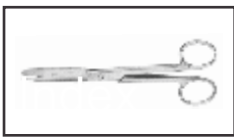

04S

SCISSORS



NEWMAX CORPORATION

Straight

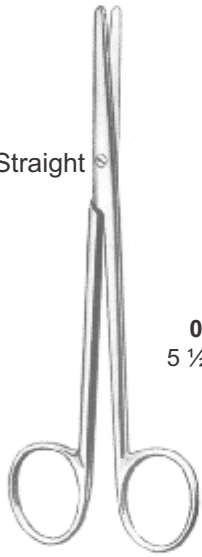

Metzenbaum Scissors



04S-071
5 1/2" (14 cm)



04S-072
7" (18 cm)



04S-073
8" (20 cm)



04S-074
9" (23 cm)



04S-075
10" (25 cm)



04S-076
11" (28 cm)



04S-077
12" (30 cm)

Curved

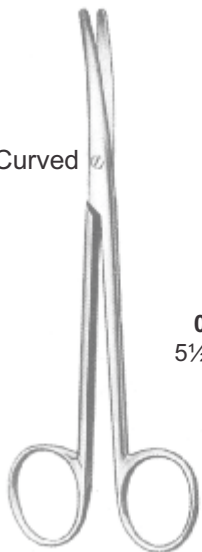

Metzenbaum Scissors



04S-078
5 1/2" (14 cm)



04S-079
7" (18 cm)



04S-080
8" (20 cm)



04S-081
9" (23 cm)



04S-082
10" (25 cm)



04S-083
11" (28 cm)



04S-084
12" (30 cm)

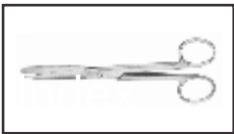

04S

SCISSORS



NEWMAX CORPORATION

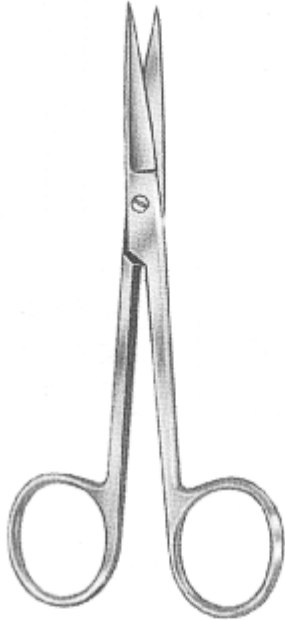

Iris Scissors

ARTICLE # Straight	ARTICLE # Curved	SIZE
04S-085	04S-088	3 1/2" (9 cm)
04S-086	04S-089	4" (10 cm)
04S-087	04S-090	4 1/2" (11 cm)



Stevens Strabismus Scissors

ARTICLE # Straight	ARTICLE # Curved	SIZE
04S-091	04S-093	4" (10 cm)
04S-092	04S-094	4 1/2" (11 cm)

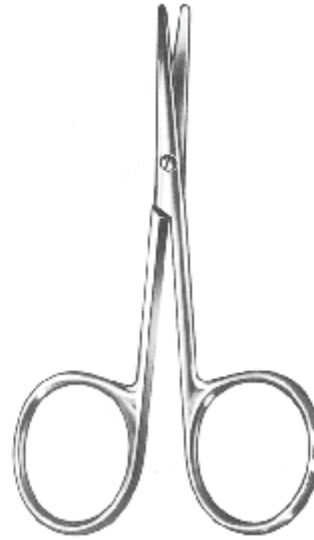

Lexer-Baby Scissors

ARTICLE # Straight	SIZE
04S-095	4 1/4" (11 cm)
04S-096	5" (12,5 cm)

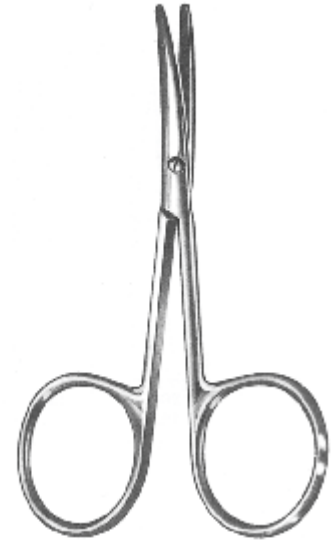

Lexer-Baby Scissors

ARTICLE # Curved	SIZE
04S-097	4 1/4" (11 cm)
04S-098	5" (12,5 cm)

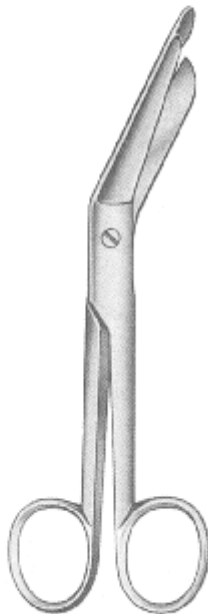

Lister Bandage Scissors

ARTICLE #	SIZE
# 04S-099	3 1/2" (9 cm)
04S-100	4 1/2" (11 cm)
04S-101	5 1/2" (14 cm)
04S-102	7" (18 cm)
04S-103	8" (20 cm)

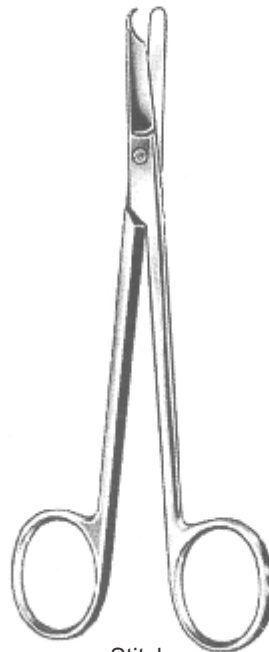

Stitch
Ligature Scissors

ARTICLE #	SIZE
04S-104	3 1/2" (9 cm)
04S-105	4 1/2" (11 cm)
04S-106	5 1/2" (14 cm)

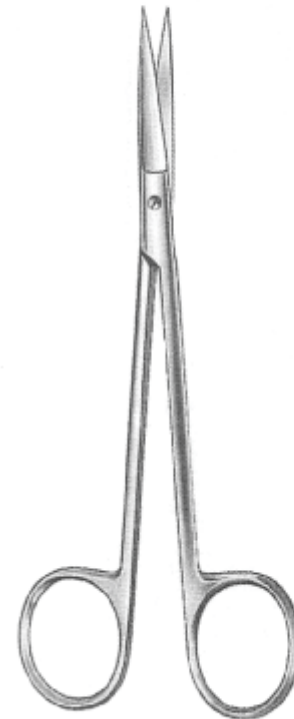

04S-107
Joseph Scissors
5 3/4" (14.5 cm)



SCISSORS

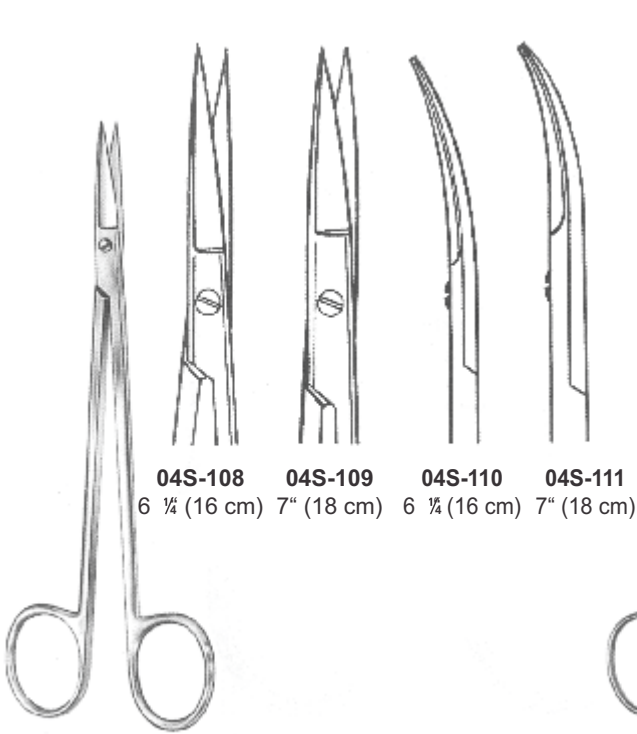

04S-108 6 ¼" (16 cm)
04S-109 7" (18 cm)
04S-110 6 ¼" (16 cm)
04S-111 7" (18 cm)

Kelly Scissors

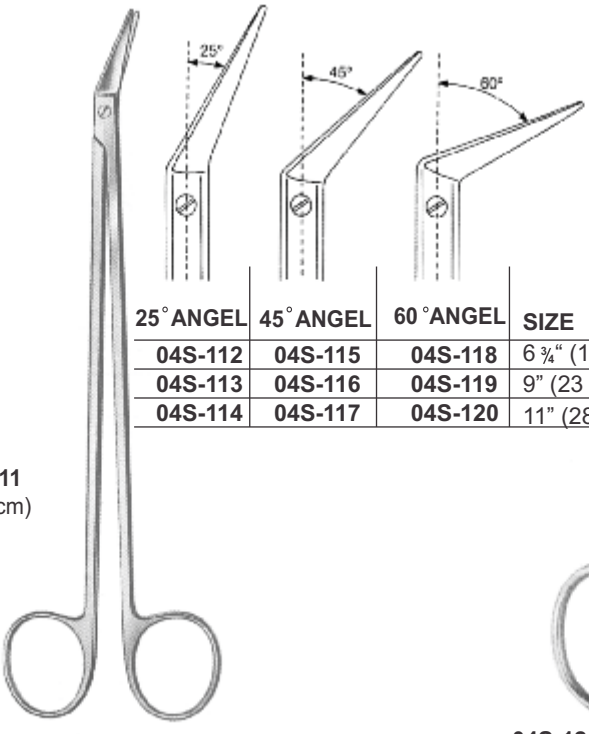

25° ANGEL	45° ANGEL	60° ANGEL	SIZE
04S-112	04S-115	04S-118	6 ¾" (17 cm)
04S-113	04S-116	04S-119	9" (23 cm)
04S-114	04S-117	04S-120	11" (28 cm)

De-Bakey Scissors

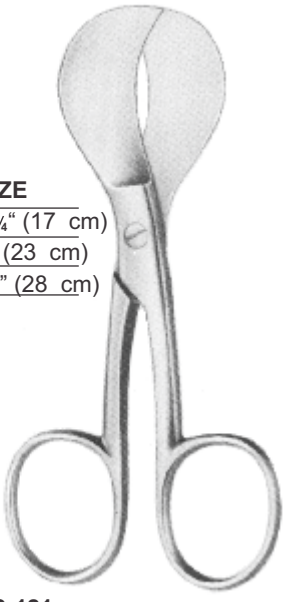

04S-121
 US Umbilical Scissors 4 ¼" (10,5 cm)

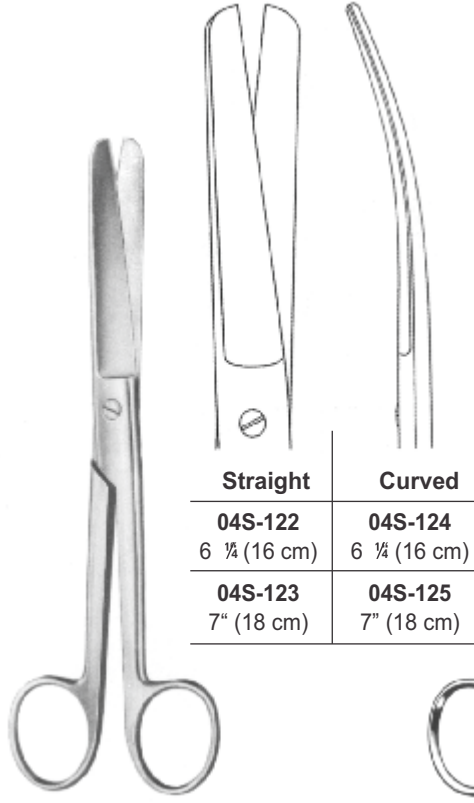

Straight	Curved
04S-122 6 ¼" (16 cm)	04S-124 6 ¼" (16 cm)
04S-123 7" (18 cm)	04S-125 7" (18 cm)

Doyen Abdominal Scissors

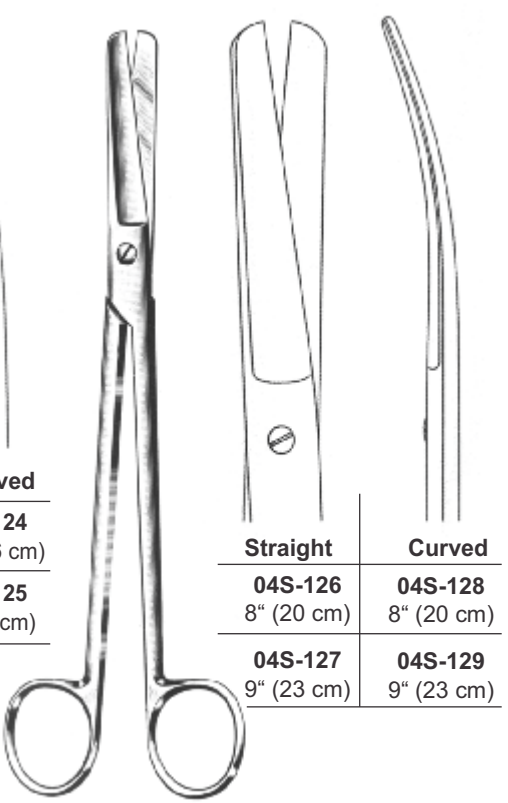

Straight	Curved
04S-126 8" (20 cm)	04S-128 8" (20 cm)
04S-127 9" (23 cm)	04S-129 9" (23 cm)

Parametrium Scissors

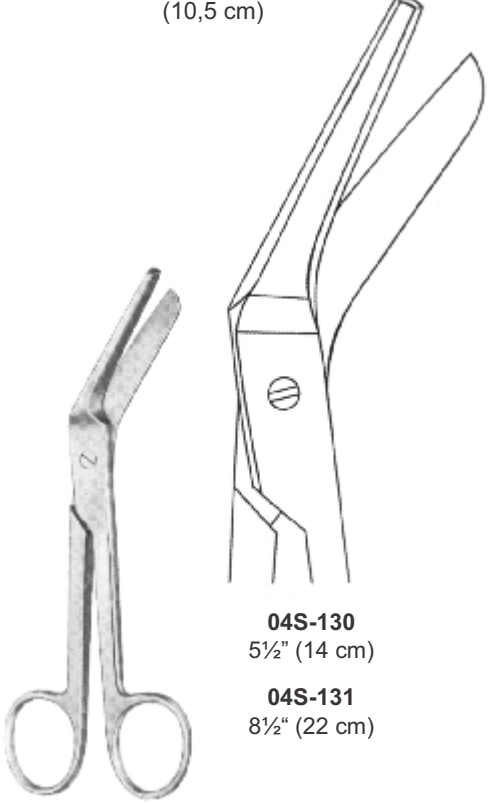

04S-130
5 ½" (14 cm)
04S-131
8 ½" (22 cm)

Braun-Stadler Scissors

DRESSING & TISSUE FORCEPS

05S

SERRATED

1X2 TEETH

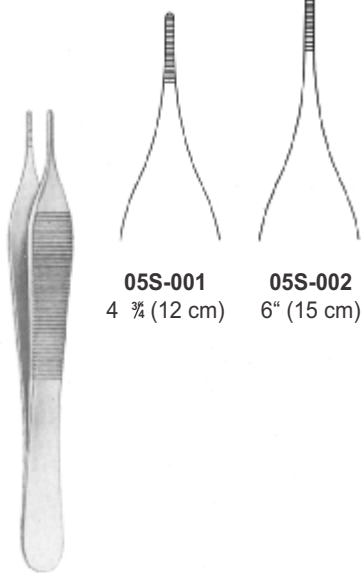

05S-001
4 3/4" (12 cm)

05S-002
6" (15 cm)



05S-003
4 3/4" (12 cm)

05S-004
6" (15 cm)

Adson Forceps



05S-005
Adson-Brown Forceps
4 3/4" (12 cm)



05S-006 Adson
Forceps Serrated
4 3/4" (12 cm)



05S-007 Adson
Forceps
1X2 TEETH
4 3/4" (12 cm)



05S-008
Adson Forceps
1X2 TEETH
WITH TYING
PLATFORM
4 3/4" (12 cm)



05S-009
Adson Brown Forceps
4 3/4" (12 cm)

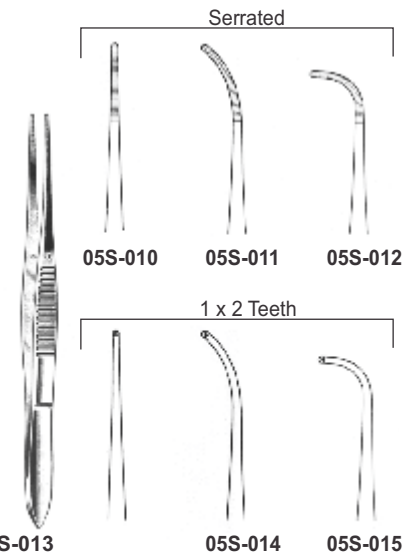

05S-013
Splinter
Forceps
4 1/2" (11.5 cm)

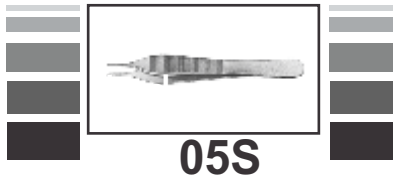

05S

DRESSING & TISSUE FORCEPS



Dressing Forceps

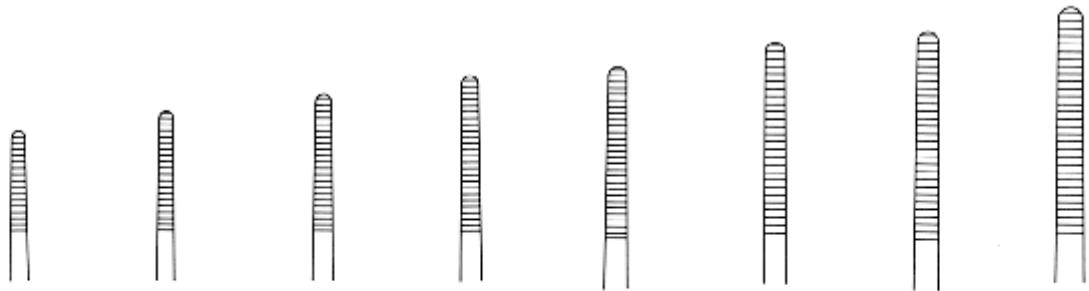

- | | | | | | | | |
|------------------|----------------|------------------|----------------|----------------|----------------|----------------|----------------|
| 05S-016 | 05S-017 | 05S-018 | 05S-019 | 05S-020 | 05S-021 | 05S-022 | 05S-023 |
| 4 1/2" (11.5 cm) | 5" (13 cm) | 5 1/2" (14.5 cm) | 6 1/4" (16 cm) | 7" (18 cm) | 8" (20 cm) | 10" (25 cm) | 12" (30 cm) |



Tissue Forceps

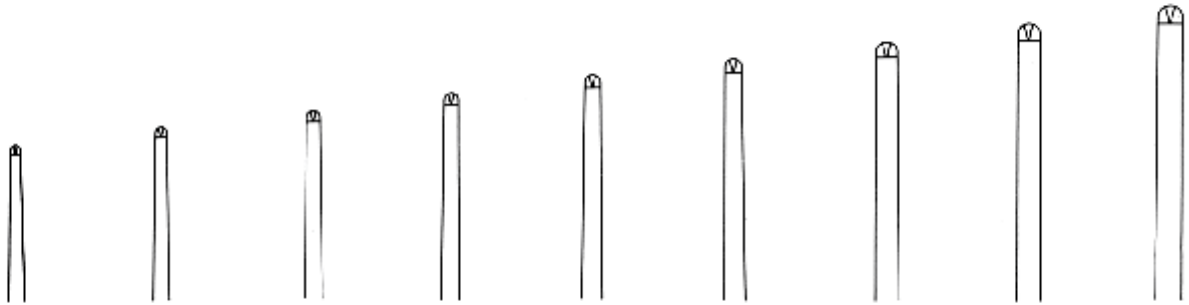

- | | | | | | | | | |
|----------------|------------------|----------------|------------------|----------------|----------------|----------------|----------------|----------------|
| 05S-024 | 05S-025 | 05S-026 | 05S-027 | 05S-028 | 05S-029 | 05S-030 | 05S-031 | 05S-032 |
| 4 1/4" (11 cm) | 4 1/2" (11.5 cm) | 5" (13 cm) | 5 1/2" (14.5 cm) | 6 1/4" (16 cm) | 7" (18 cm) | 8" (20 cm) | 10" (25 cm) | 12" (30 cm) |

DRESSING & TISSUE FORCEPS

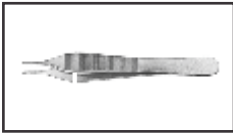

05S



05S-033
6" (15 cm)

McIndoe Forceps



05S-034
6" (15 cm)

Serrated

Gillies Dressing Forceps



05S-035
5" (12.5 cm)

1 x 2 Teeth

05S-037
5" (12.5 cm)

Semken Dressing & Tissue Forceps



Serrated



05S-036
6" (155 cm)



05S-038
6" (155 cm)

Taylor Dressing & Tissue Forceps



05S-039
7" (17 cm)

05S-040
7" (17 cm)

Taylor Dressing & Tissue Forceps



05S-041
7" (18.5 cm)



05S-042
7" (18.5 cm)



1 x 2 Teeth

05S-043
7" (18 cm)

05S-045
7" (18 cm)

Gerald Dressing & Tissue Forceps

Serrated



05S-044
7" (18 cm)



05S-046
7" (18 cm)



Serrated



1 x 2 Teeth

05S-047
7" (17.5 cm)

05S-049
7" (17.5 cm)

Cushing Dressing & Tissue Forceps



05S-048
7" (17.5 cm)



05S-050
7" (18 cm)

05S-053
7" (18 cm)

Potts-Smith Dressing & Tissue Forceps



Serrated



05S-051
8 ¼ (21 cm)

05S-054
8 ¼ (21 cm)



05S-052
10" (25 cm)

05S-055
10" (25 cm)

DRESSING & TISSUE FORCEPS

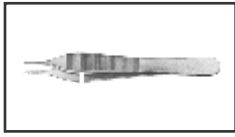

05S



Durante Tissue Forceps



05S-056
5½" (14.5 cm)



05S-057
6 ¼" (16 cm)



05S-058
8" (20 cm)



Bonney Tissue Forceps



05S-059
7" (18 cm)



Stone Tissue Forceps



05S-060
6" (15 cm)



Lerche Tissue Forceps



05S-061
6" (15 cm)



Mayo-Russ Tissue Forceps



05S-062
9" (23 cm)



Singley-Tuttle Tissue Forceps



05S-063
9" (23 cm)



Russ. Modell Tissue Forceps



05S-064
6" (15 cm)



05S-065
8" (20 cm)



05S-066
10" (25 cm)



Duval Tissue Forceps



05S-067
5½" (14.5 cm)



Collin-Duval Grasping Forceps



05S-068
8" (20 cm)

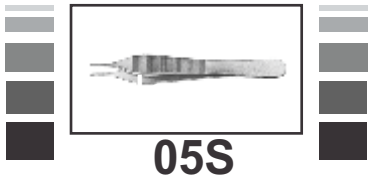

DRESSING & TISSUE FORCEPS



05S-069
Carhalt Splinter
Forceps 4 1/4" (11 cm)



05S-070
Carhalt Splinter
Forceps 4 1/4" (11 cm)

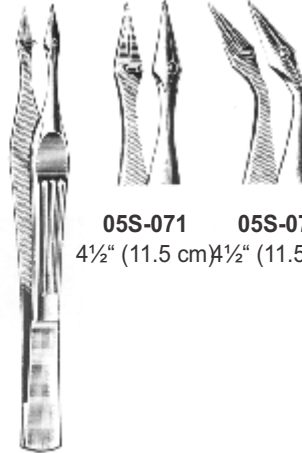

05S-071 **05S-072**
4 1/2" (11.5 cm) 4 1/2" (11.5 cm)

Walter Splinter Forceps



05S-073
Feilchenfeld
Splinter Forceps 3"
(8 cm)



05S-074
Splinter Forceps
with Magnify
Glass 3" (8 cm)



05S-075
5" (12.5 cm)

Physicians Splinter Forceps

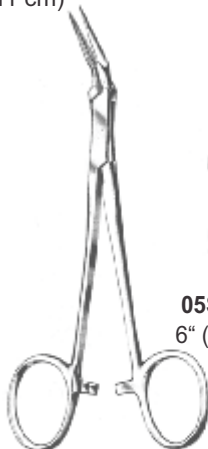

05S-076
6" (15 cm)

Williams Splinter Forceps

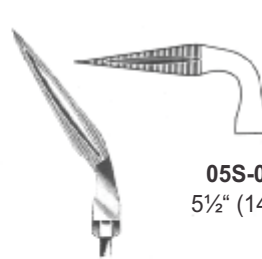

05S-077
6" (15 cm)

05S-078
5 1/2" (14 cm)



Virtus Splinter

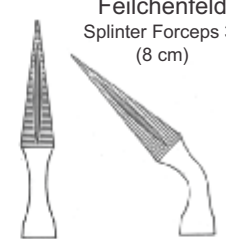

05S-079
5 1/2"

05S-080
5 1/2"

Swiss Jeweler Forceps



05S-081
4 3/4" (12 cm)



05S-082
4 3/4" (12 cm)



05S-083
4 3/4" (12 cm)



05S-084
4 3/4" (12 cm)



05S-085
4 3/4" (12 cm)

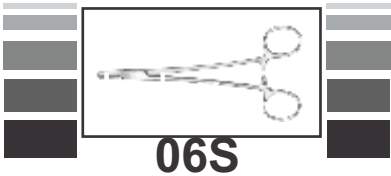

NEEDLE HOLDER



06S-001
4 ¾" (12 cm)

06S-002
5" (12.5 cm)

Derf Needle Holder



06S-003
Collier Needle
Holder 5" (12.5 cm)

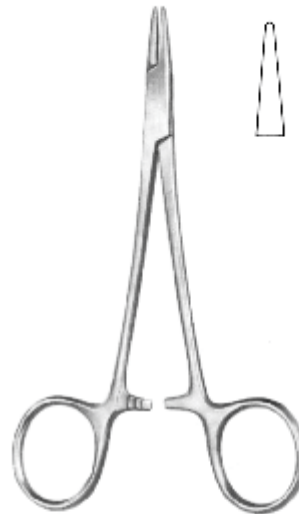

06S-004
Webster Needle
Holder 5" (13 cm)



06S-005
Halsey Needle
Holder 5" (13 cm)



06S-006
Neivert Needle
Holder 5" (13 cm)



06S-007
Hegar-Baumgartner Needle
Holder 5 ½" (14 cm)



Brown Needle Holder

ARTICLE #	SIZE
06S-008	5" (12.5 cm)
06S-009	7" 18 cm)

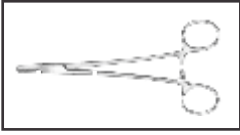

06S

NEEDLE HOLDER



NEWMAX CORPORATION

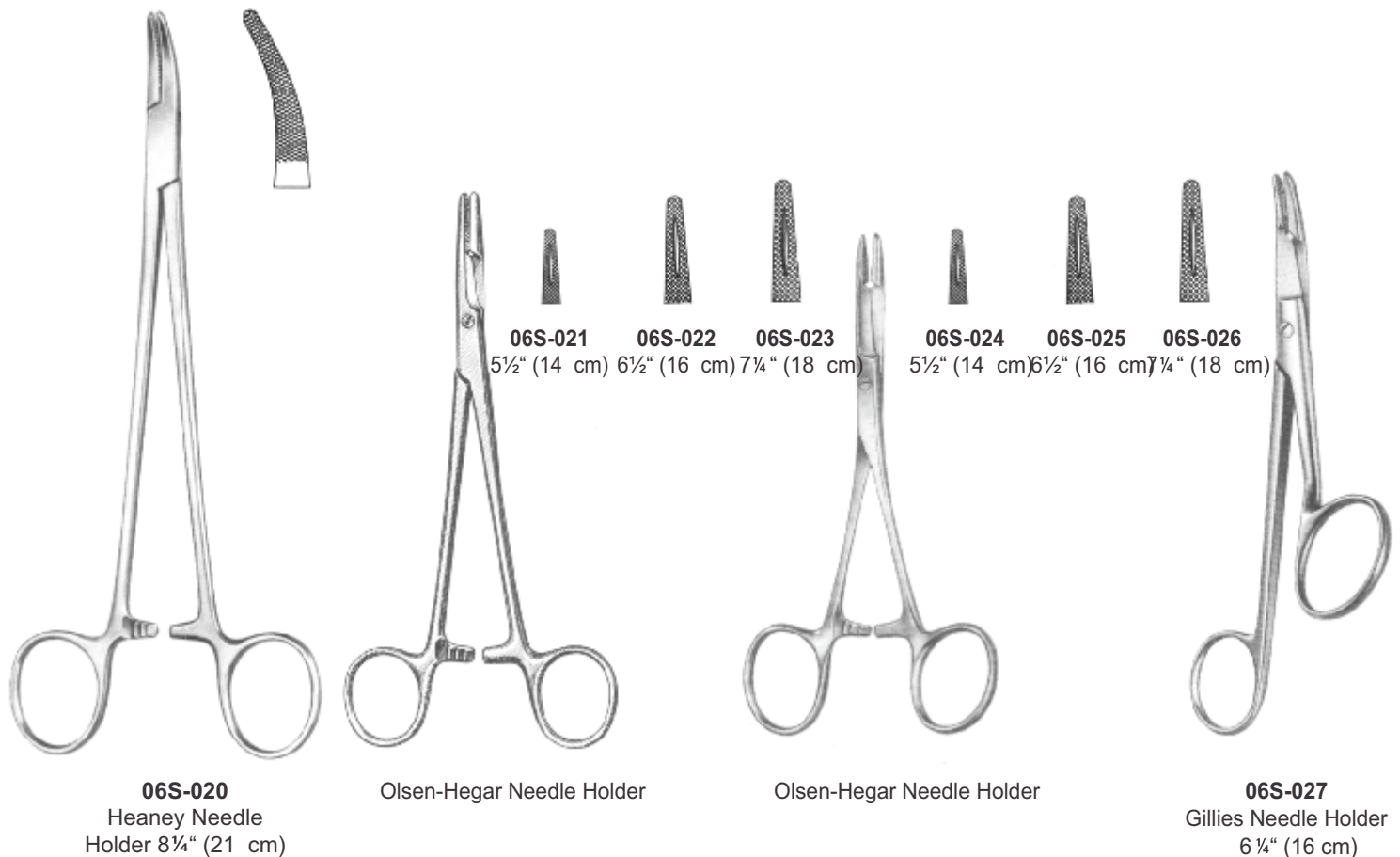
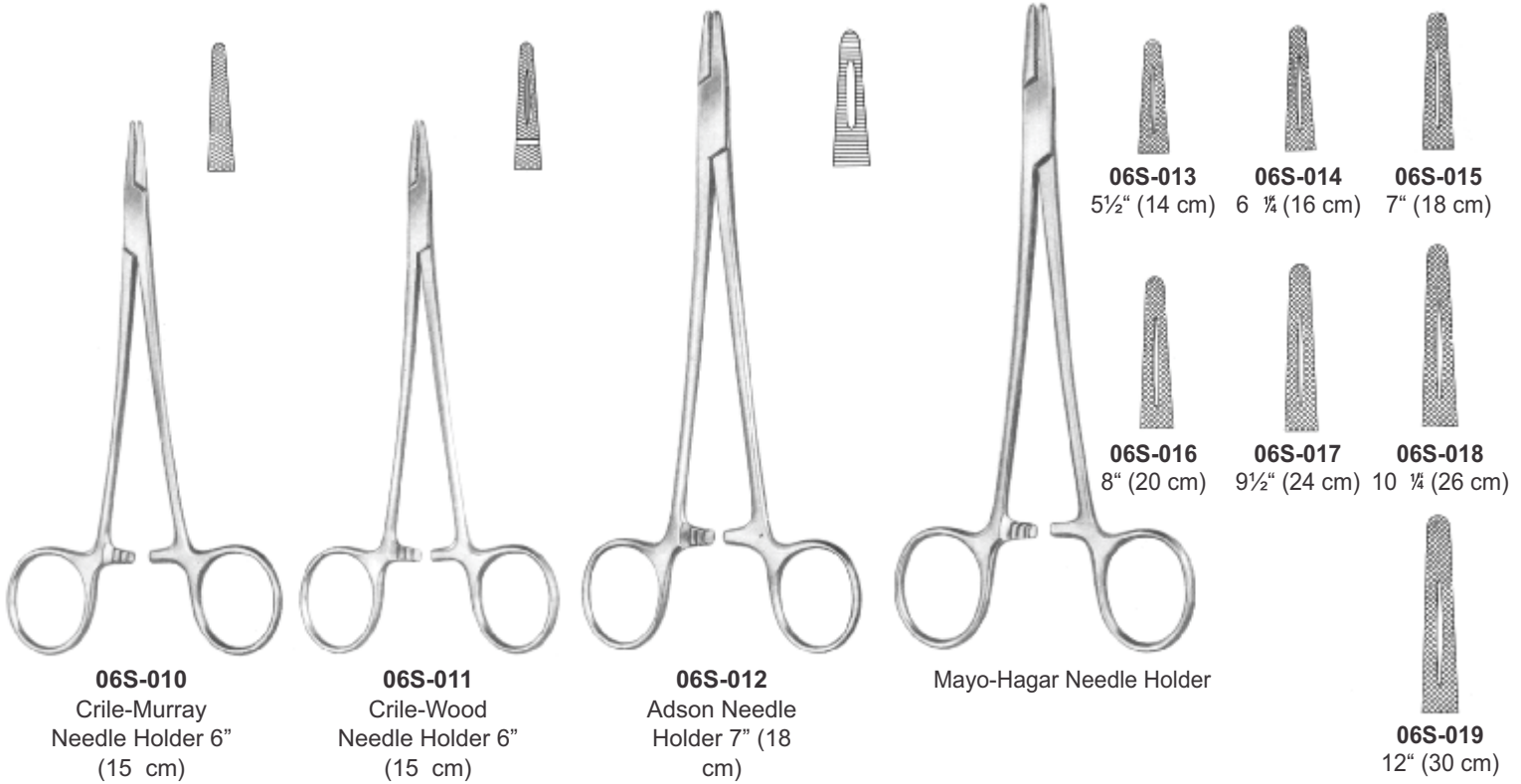

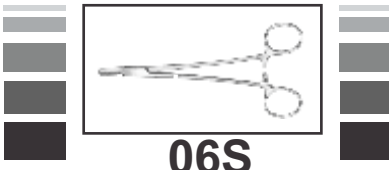

NEEDLE HOLDER



06S-028
Crile Needle Holder
6" (15 cm)



Mathieu Needle Holder

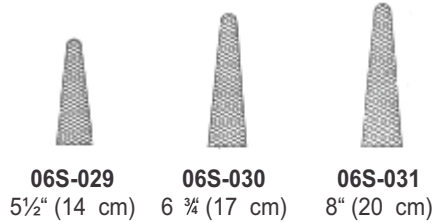

06S-029 5½" (14 cm) **06S-030** 6¾" (17 cm) **06S-031** 8" (20 cm)



Mathieu Needle Holder

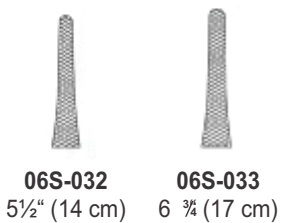

06S-032 5½" (14 cm) **06S-033** 6¾" (17 cm)



06S-034
Toennis Needle Holder
7" (18 cm)

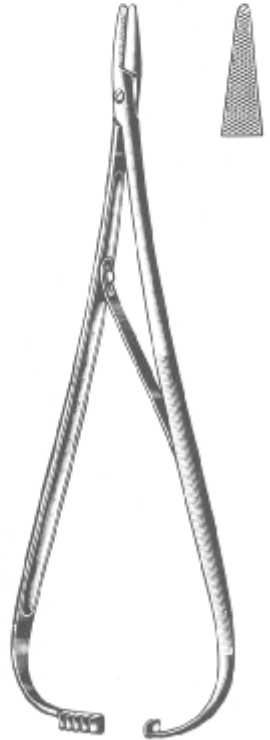

06S-035
Lichtenberg Needle Holder
8" (20 cm)

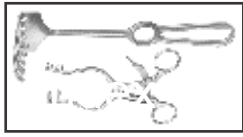

07S

RETRACTORS

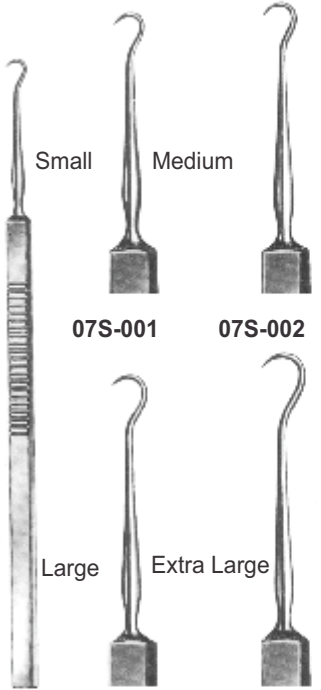

Small Medium
07S-001 **07S-002**
 Large Extra Large
07S-003 **07S-004**

Graefe Hook
 6¼" (16 cm)

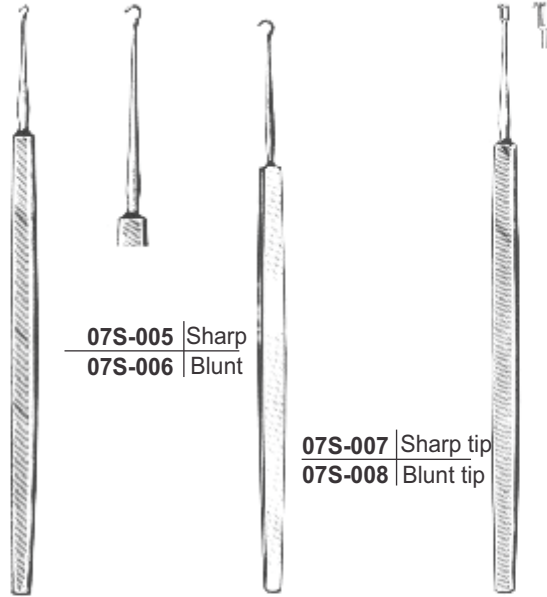

07S-005 Sharp
07S-006 Blunt
07S-007 Sharp tip
07S-008 Blunt tip

Tyreel Hook
 5" (12.5 cm)

Frazier Dura Hook
 5" (12.5 cm)

07S-009
 Guthrie Skin Hook
 5" (12.5 cm) 2 Prong



07S-010 **07S-011**
 Wiener Skin Hook Wiener Skin Hook
 5" (12.5 cm), sharp 5" (12.5 cm), Blunt

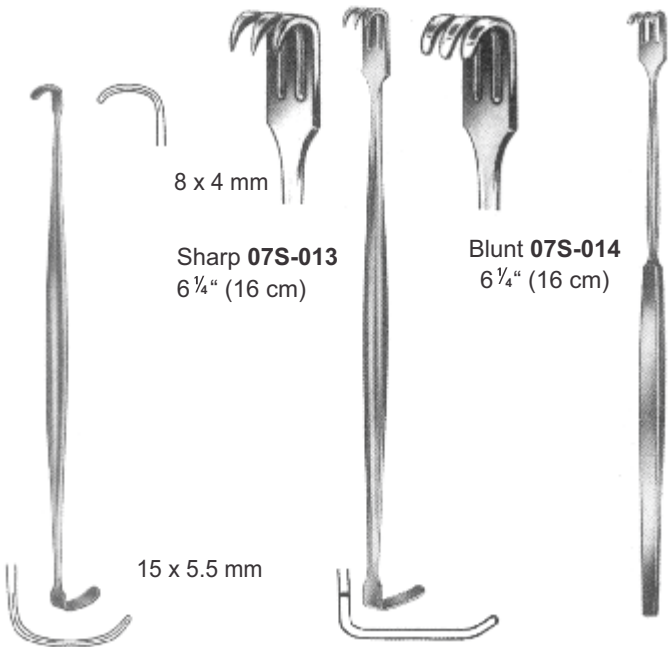

07S-012
 Ragnell Davis
 Retractor 5½"
 (14 cm)

Senn-Mueller Retractor

Trachea Retractor
 6¼" (16 cm)

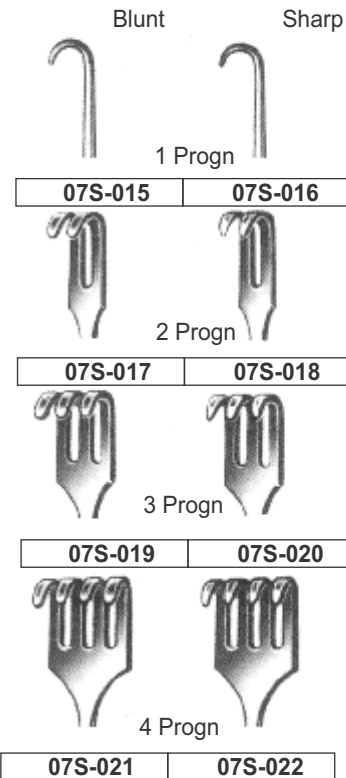

Blunt Sharp
 1 Progn
07S-015 **07S-016**
 2 Progn
07S-017 **07S-018**
 3 Progn
07S-019 **07S-020**
 4 Progn
07S-021 **07S-022**

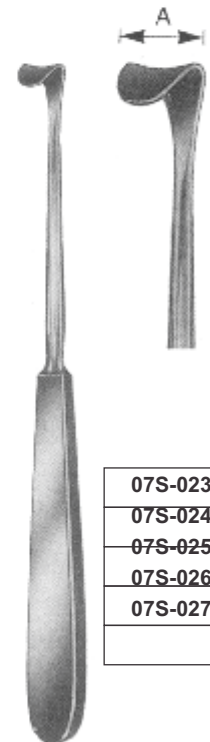

Morse Retractor
 9" (23 cm)

07S-023	A = 10mm
07S-024	A = 20mm
07S-025	A = 30mm
07S-026	A = 40mm
07S-027	A = 50mm

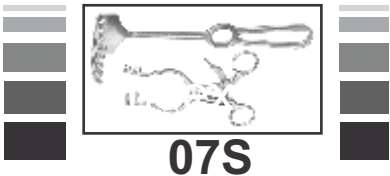

07S

RETRACTORS



Desmarres Retractor
6 ¼ (16 cm)



8mm
07S-028



10mm
07S-029



12mm
07S-030



14mm
07S-031



16mm
07S-032

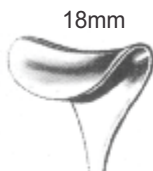

18mm
07S-033

Fig. 2 = 49x38mm
Fig. 1 = 28x20mm



Fig. 2
Fig. 1 = 36x28mm
Fig. 2 = 71x43mm
07S-034
Richardson
Eastman

Fig. 2 = 25x15mm
Fig. 1 = 21x15mm



Fig. 1 = 40x15mm
Fig. 2 = 45x15mm
07S-035
US-Army (Parker-Langenbeck)
8 ¼" (21 cm)

Fig. 2 = 30x10mm 27x16mm
Fig. 1 = 26x10mm 23x16mm



Fig. 1 = 30x13mm 26x16mm
Fig. 2 = 34x13mm 30x16mm
07S-036 **07S-037**
Farabeuf Farabeuf
4 ¾" (12 cm) 6" (15 cm)



07S-038
5" (13 cm)

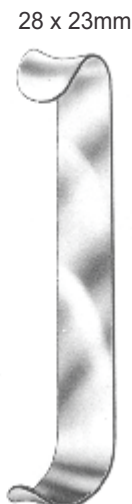

07S-039
6 ¼ (16.5 cm)



07S-040
7" (18 cm)



07S-041
Mini-Roux Retractor
6" (15 cm)

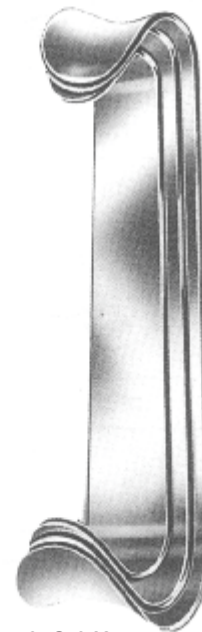

07S-042
Roux Retractor 6 ¼"
(Complete Set)

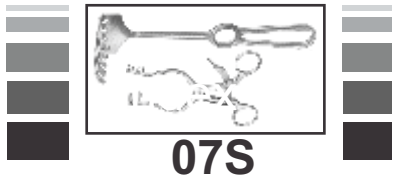

RETRACTORS

Deaver Retractor

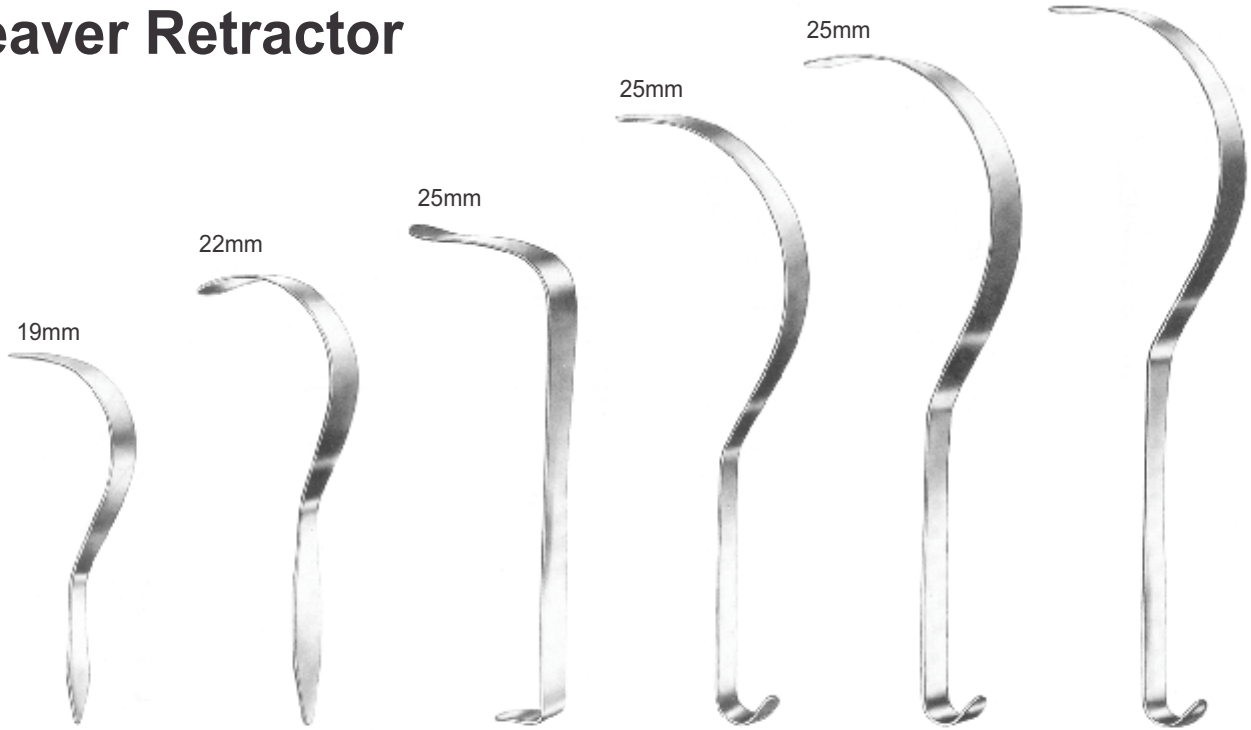

07S-043
7½" (19 cm)

07S-044
8 ¾" (22 cm)

07S-045
9 ¾" (25 cm)

07S-046
12" (30 cm)

07S-047
13" (33 cm)

07S-048
14" (36 cm)

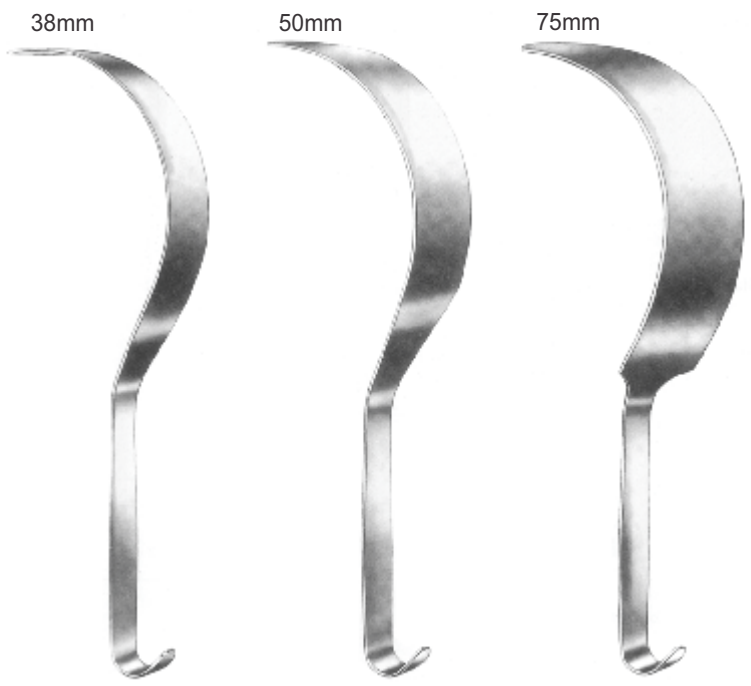

07S-049
12" (30 cm)

07S-050
12" (30 cm)

07S-051
12" (30 cm)



07S

RETRACTORS



Volkmann Retractor

	9 x 8mm	9 x 13mm	9 x 19mm	9 x 29mm	9 x 40mm		
Sharp							
	07S-052	07S-053	07S-054	07S-055	07S-056	07S-057	
							8½" (21.5 cm)
Blunt							
	07S-058	07S-059	07S-060	07S-061	07S-062	07S-063	
							8½" (21.5 cm)
Semi-Blunt							
	07S-064	07S-065	07S-066	07S-067	07S-068	07S-069	
							8½" (21.5 cm)



Mini Langenbeck Retractor
6 ¼ (16 cm)

10 x 6mm	20 x 6mm
07S-070	07S-071
75 x 5mm	28 x 8mm
07S-072	07S-073

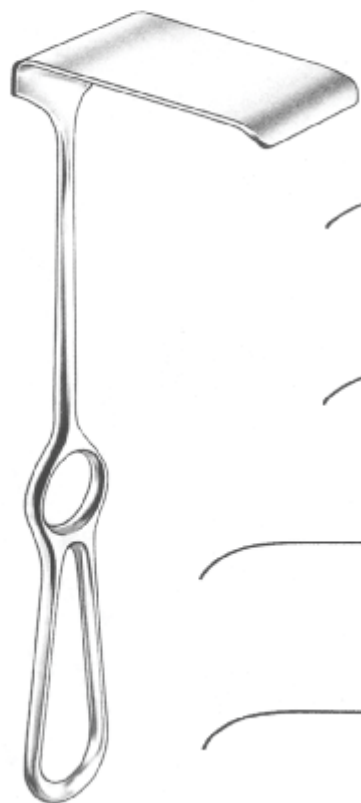

Kocher Retractor
9" (23 cm)

	07S-074 40 x 18mm
	07S-075 60 x 20mm
	07S-076 60 x 25mm
	07S-077 75 x 30mm
	07S-078 75 x 40mm

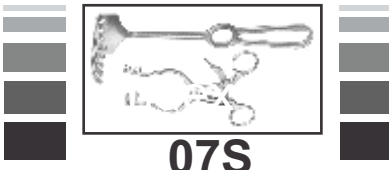

RETRACTORS



Kocher-Langenbeck Retractor
8½" (21.5 cm)



07S-083
35 x 15mm

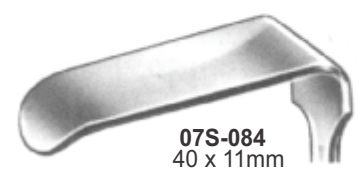

07S-084
40 x 11mm



07S-085
55 x 11mm



07S-079
25 x 6mm



07S-080
25 x 8mm



07S-081
35 x 8mm



07S-082
35 x 11mm



07S-086
70 x 14mm

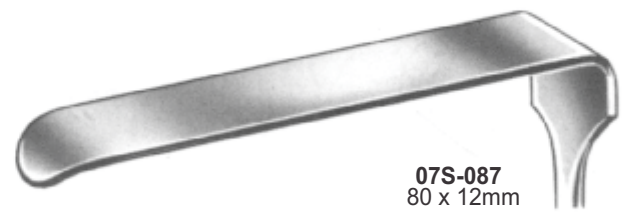

07S-087
80 x 12mm

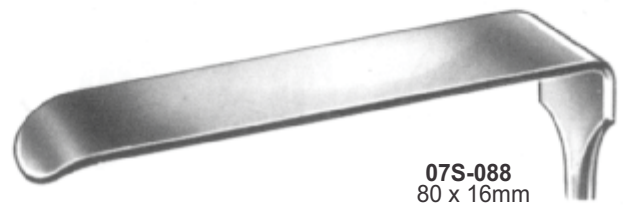

07S-088
80 x 16mm

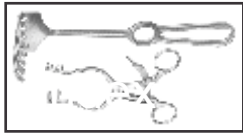

07S

RETRACTORS



Middeldorpf Retractor

ARTICLE #	WIDE	SIZE
07S-089	14x17mm	8 1/4" (21.5 cm)
07S-090	20x22mm	8 3/4" (22.0 cm)
07S-091	26x30mm	9" (23.5 cm)



Richardson Retractor

ARTICLE #	WIDE	SIZE
07S-092	28x20mm	9 " (24 cm)
07S-093	36x28mm	9 (24 cm)
07S-094	44x38mm	9 (24 cm)
07S-095	52x22mm	9 (24 cm)

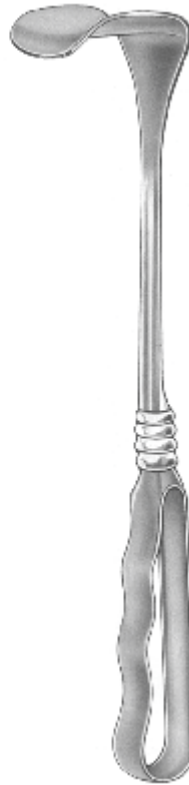

07S-096

Kelly Retractor 65 x 50 mm 10" (26 cm)

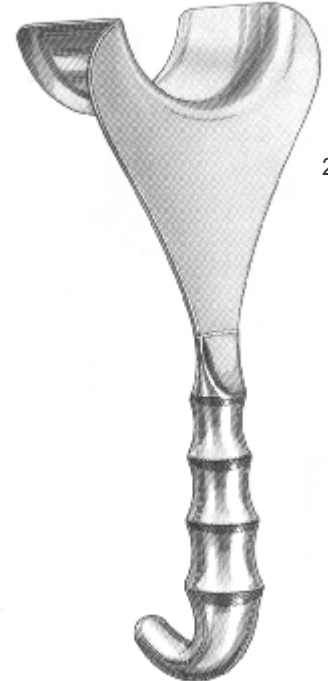

2 3/4 " x 2"

07S-097

Delee Retractor



Fritsch Retractor
9 1/2" (24 cm)

ARTICLE #	WIDE
07S-098	45x40mm
07S-099	45x50mm
07S-100	45x60mm
07S-101	45x75mm
07S-102	65x85mm



07S-103
Kocher Retractor
8 3/4 (22.5 cm)



Kocher Retractor
9 3/4" (25 cm)

ARTICLE #	WIDE
07S-104	80x42mm
07S-105	80x50mm
07S-106	80x60mm

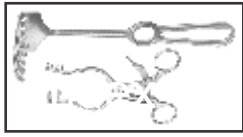

07S

RETRACTORS



Gelpi Retractor

ARTICIE #	SIZE
07S-107	5" (13.5 cm)
07S-108	7" (17.5 cm)

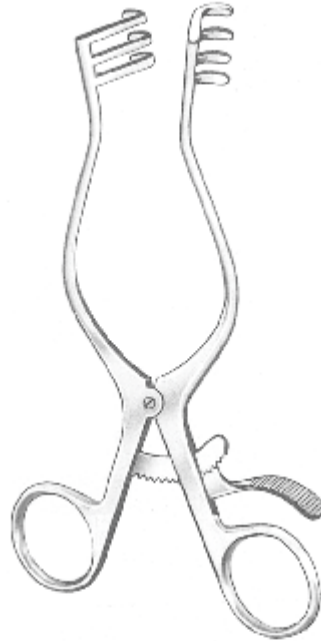

Weitlaner Retractor

Sharp	Blunt	Length	Prongs
07S-109	07S-114	4 1/4" (10 cm)	2 x 3
07S-110	07S-115	5" (13 cm)	3 x 4
07S-111	07S-116	6 1/4" (16 cm)	3 x 4
07S-112	07S-117	8" (20 cm)	3 x 4
07S-113	07S-118	9 3/4" (25 cm)	3 x 4

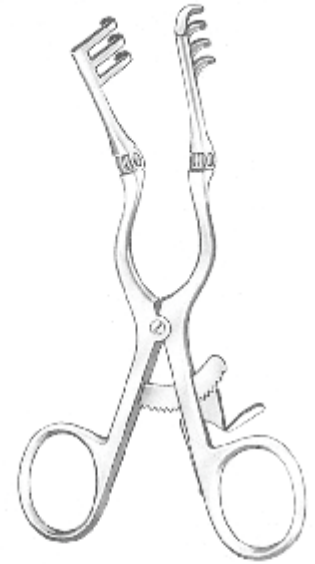

Cone Retractor

Sharp	Blunt	Length	Prongs
07S-119	07S-122	5" (13 cm)	3 x 4
07S-120	07S-123	6 1/2" (16cm)	3 x 4
07S-121	07S-124	8" (20 cm)	3 x 4



Alm Retractor

Sharp	Blunt	Length
07S-125	07S-125	4" (10 cm)
07S-126	07S-126	2 1/4" (7 cm)



07S-127
Markham-Meyerdig
Retractor
7" (18 cm)



07S-128
Miskimon Retractor
7 1/2" (19 cm)

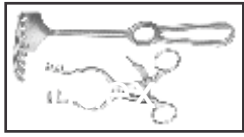

07S

RETRACTORS

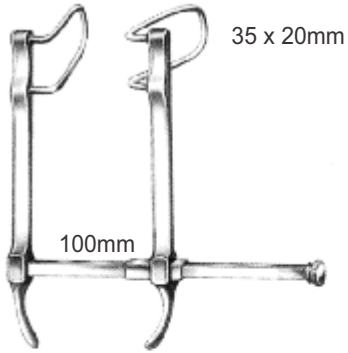

07S-129
Gosset Retractor

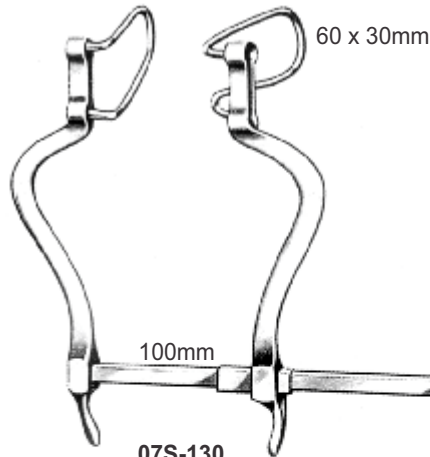

07S-130
Gosset Retractor



07S-131
Gosset Retractor

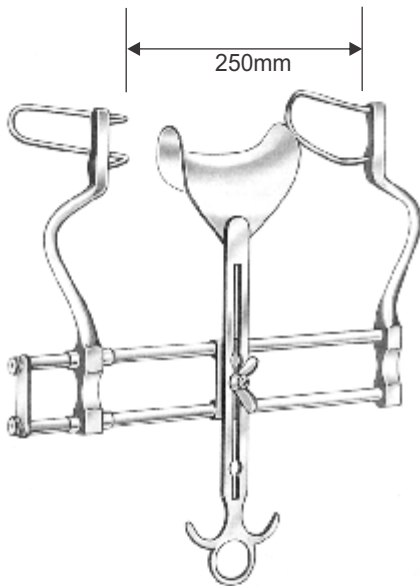

07S-132
Balfour Retractor

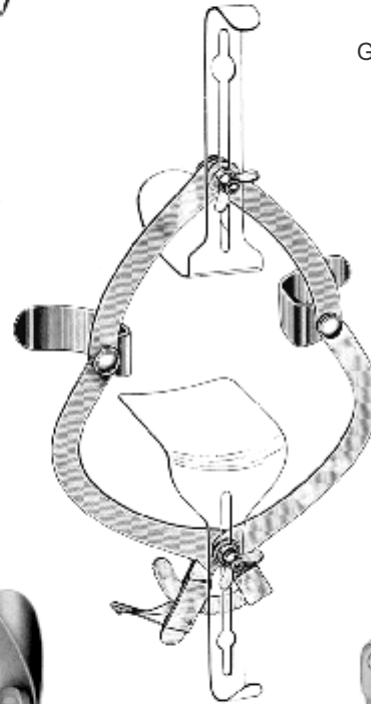

07S-133
O'Sullivan-
O'Connor
Abdominal
Retractor



07S-134
Balfour Center Blade



07S-135
Collin Abdominal
Retractor 9" (23 cm)



Collin Retractor

ARTICLE #	SIDE BLADE	CENTER BLADE
07S-136	38 x 60mm	38 x 55mm
07S-137	38 x 80mm	50 x 75mm



07S

RETRACTORS

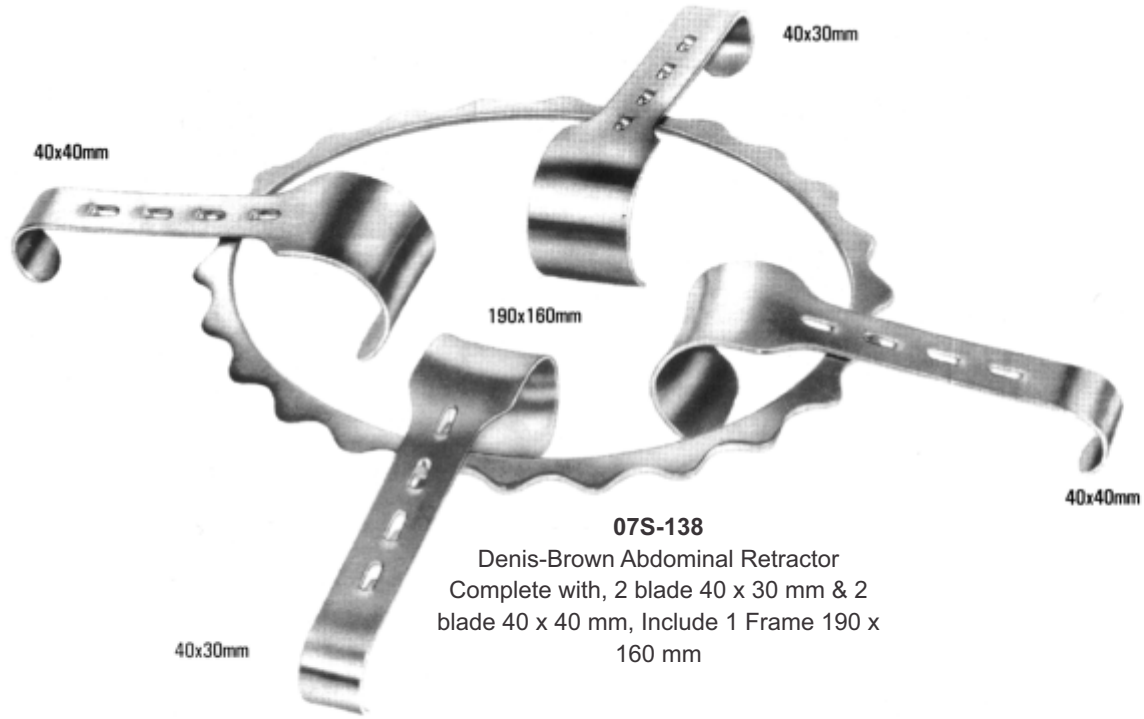

07S-138
 Denis-Brown Abdominal Retractor
 Complete with, 2 blade 40 x 30 mm & 2 blade 40 x 40 mm, Include 1 Frame 190 x 160 mm

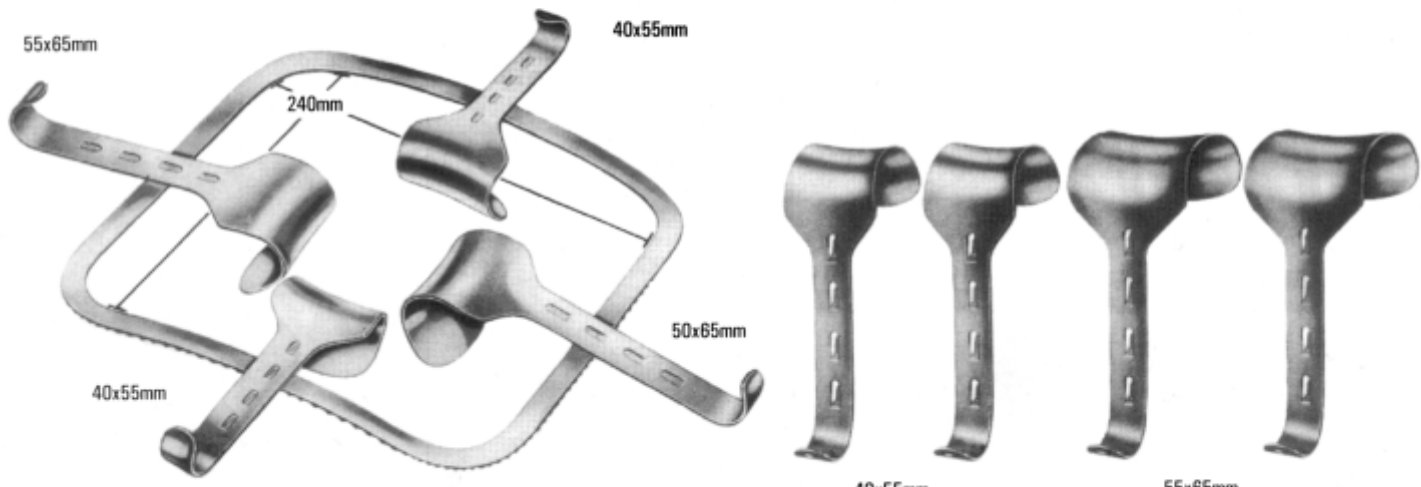

07S-139
 Kirschner Abdominal Retractor
 Complete with, 2 blade 40 x 35 mm & 2 blade 50 x 65 mm, Include 1 Frame Rigid, 240 x 240 mm

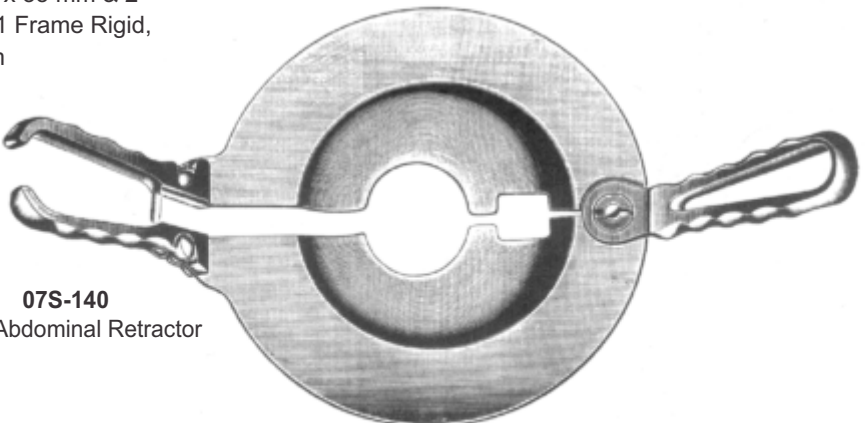

07S-140
 Percy Abdominal Retractor

ORAL INSTRUMENTS

08S



08S-001
Tongue
Depressors
7½" (19 cm)



08S-002
28mm

08S-003
32mm

Wieder Tongue Depressors
5½" (14 cm)



Magil Forceps

ARTICLE #	SIZE
08S-004	6" (16 cm)
08S-005	8" (20 cm)
08S-006	10" (25 cm)
08S-007	11" (28 cm)

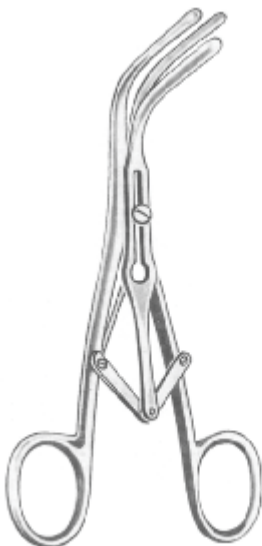

08S-008
Trocars
Laborde
Dilators
5½" (14 cm)



08S-009
Trocars
Dilatory
Trousseau
5½" (14 cm)



08S-010
Tongue Holding
Forceps Collin
6 ¾" (16 cm)



08S-011
Young Tongue
Forceps 6"
(17 cm)

08S-012
Spare Rubber

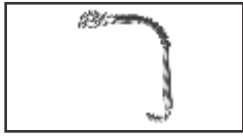

08S

ORAL INSTRUMENTS



08S-013
Meister
Mouth Gag 5"
(13 cm)

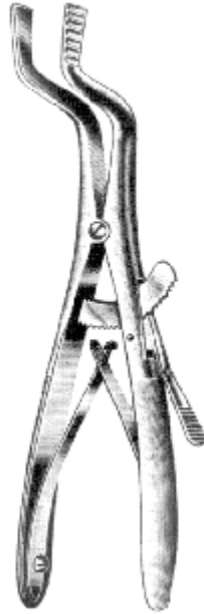

Roser-Konig Mouth Gag
ARTICLE # | **SIZE**
08S-014 | 6¼" (16 cm)
08S-015 | 7½" (19 cm)

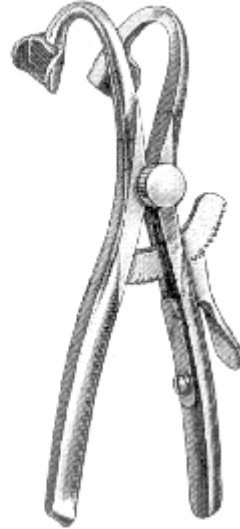

08S-016
Denhardt
Mouth Gag 6"
(15 cm)

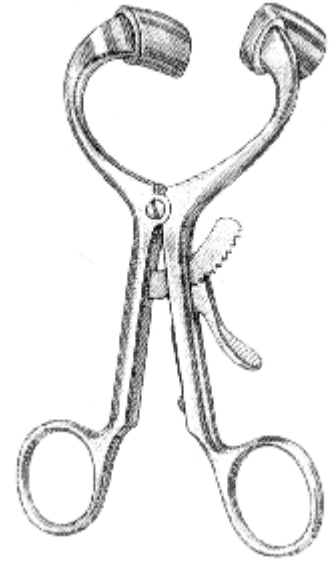

Molt Mouth Gag
ARTICLE # | **SIZE**
08S-017 | 4" (10 cm)
08S-018 | 4½" (11,5 cm)
08S-019 | 5½" (14 cm)



Whitehead Mouth Gag
ARTICLE # | **SIZE**
08S-020 | 3½" (9 cm)
08S-021 | 4¼" (11 cm)
08S-022 | 5" (13 cm)
08S-023 | 6" (15 cm)

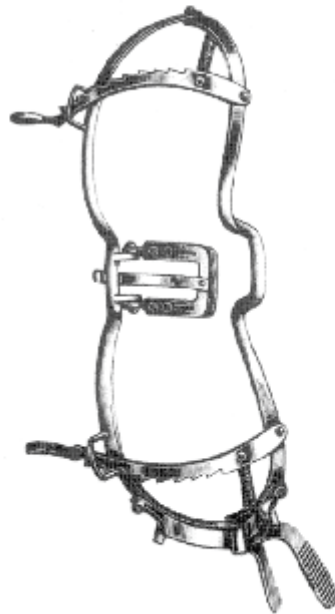

Whitehead Mouth Gag
ARTICLE # | **SIZE**
08S-024 | 3½" (9 cm)
08S-025 | 4¼" (11 cm)
08S-026 | 5" (13 cm)
08S-027 | 6" (15 cm)



Jennings Mouth Gag
ARTICLE # | **SIZE**
08S-028 | 3½" (9 cm)
08S-029 | 4¼" (11 cm)
08S-030 | 5" (13 cm)
08S-031 | 6" (15 cm)



Coloumbia Lip Retractor Double End
ARTICLE # | **SIZE**
08S-032 | 4¼" (12 cm)
08S-033 | 5½" (14 cm)
08S-034 | 6¼" (16 cm)

ORAL INSTRUMENTS

08S

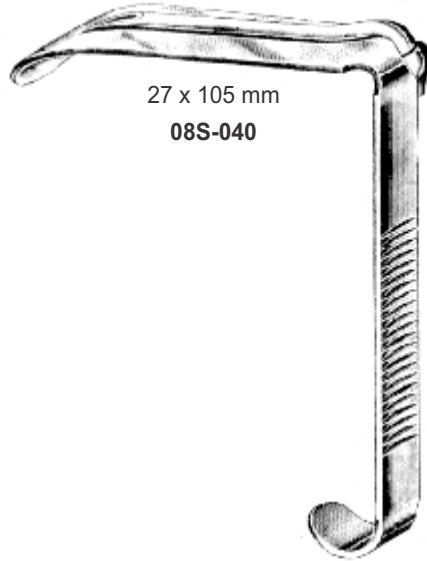
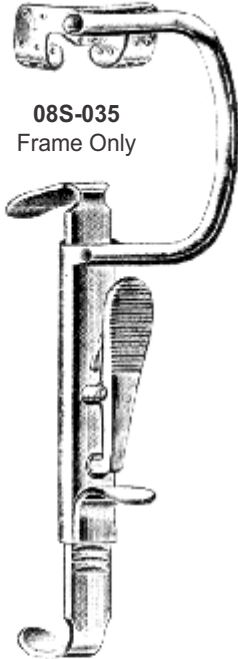

Davis-Boyle Mouth Gags

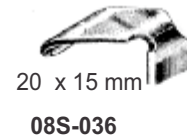
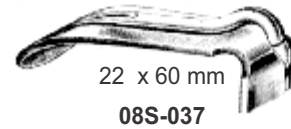
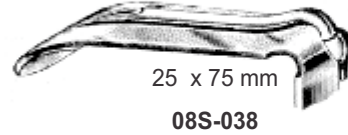
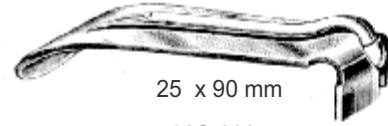

08S-045
Frame Only



27 x 95 mm
08S-044

22 x 85 mm
08S-043

22 x 70 mm
08S-042

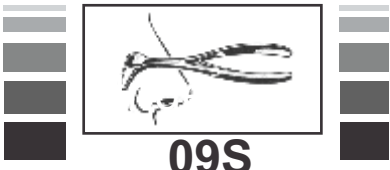

E.N.T INSTRUMENTS



Hartmann-Halle Nasal Speculum
5½" (14 cm)

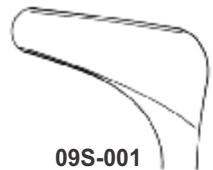

09S-001

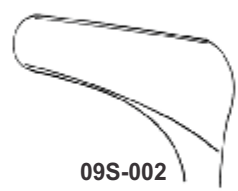

09S-002

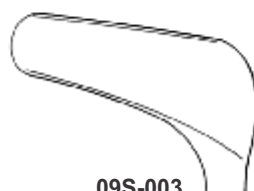

09S-003



Hartmann Nasal Speculum
5½" (14 cm)

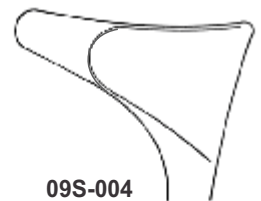

09S-004

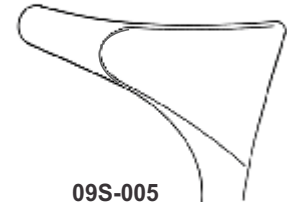

09S-005



09S-006



Tieck-Halle Nasal Speculum
5 ¼ (13.5cm)



09S-007



09S-008



09S-009
Beckmann Nasal Speculum 5" (13 cm)

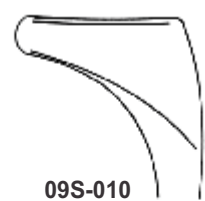

09S-010

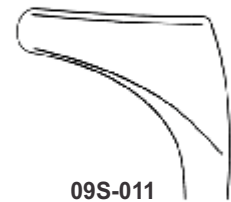

09S-011

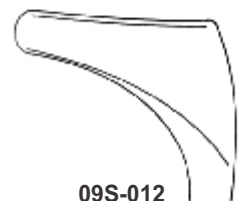

09S-012



Beckmann Nasal Speculum
5½" (14 cm)

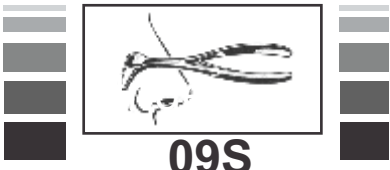

09S

E.N.T INSTRUMENTS



Killian Nasal Speculum
5" (13 cm)

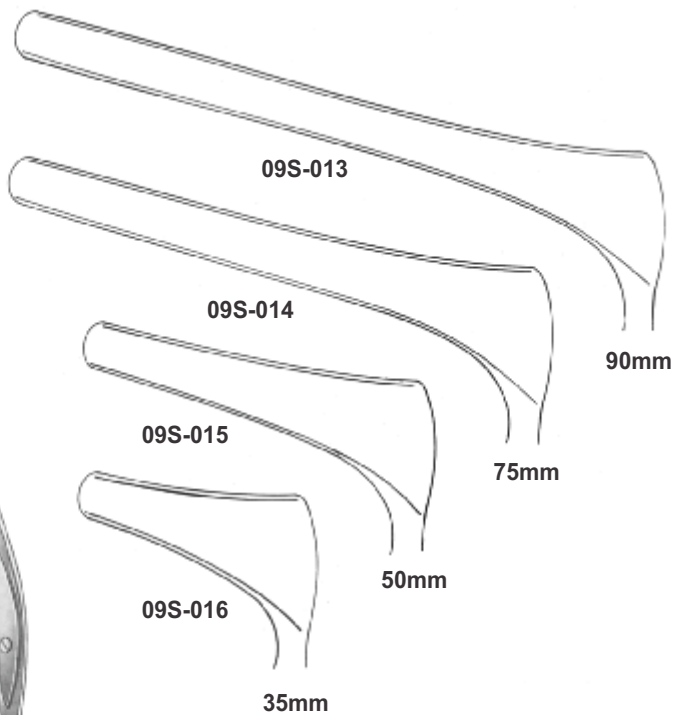

Vienna Nasal Speculum
5½" (14 cm)

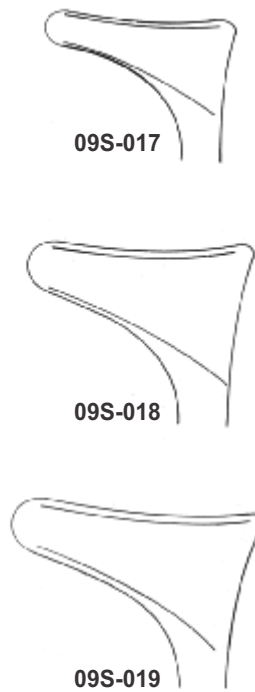

Thudichum
(Goldsmith) Nasal
Speculum 2½"
(6.5cm)



Voltolini (Duplay) Nasal Speculum

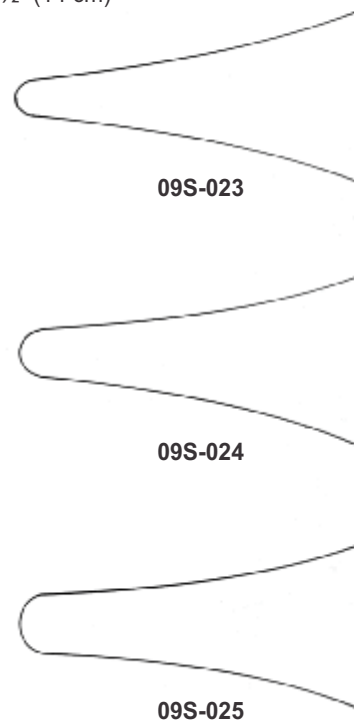



09S

E.N.T INSTRUMENTS



Politzer Ear Speculum



Toynbee Ear Speculum



Hartmann Ear Speculum



Gruber Ear Speculum

- 047
- 048
- 049
- 050

2.0	09S-026	09S-033	09S-040	09S-047
3.0	09S-027	09S-034	09S-041	09S-048
3.5	09S-028	09S-035	09S-042	09S-049
4.0	09S-029	09S-036	09S-043	09S-050
5.0	09S-030	09S-037	09S-044	
6.5	09S-031	09S-038	09S-045	
7.5	09S-032	09S-039	09S-046	

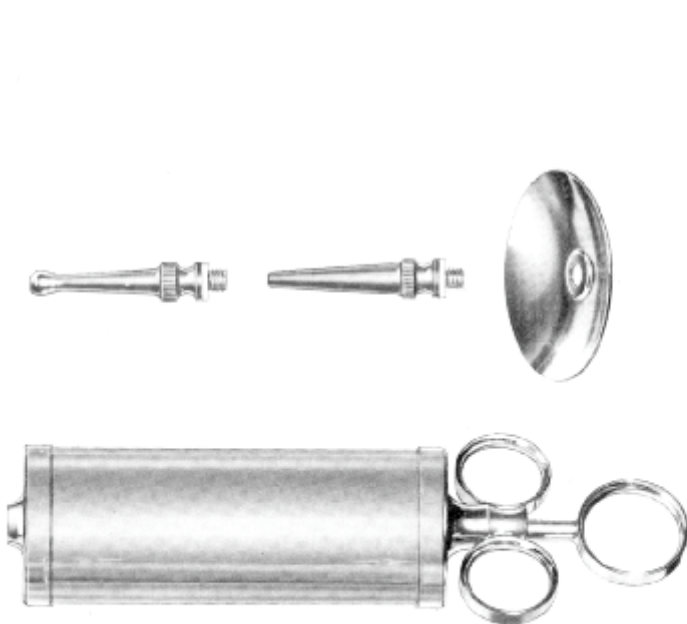

09S-051

Ear Syringe (Complete Set)



09S-052

Politzer Air Bag (Complete Set with 4 Tips)



09S

E.N.T INSTRUMENTS

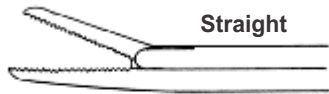

Straight

| 4,5 mm |



| 0,8 mm

09S-063

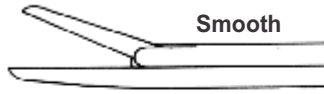

Smooth

| 4,5 mm |



| 0,8 mm

09S-062

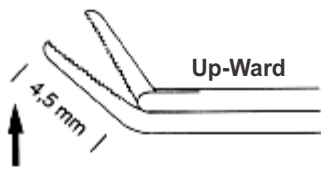

Up-Ward

| 4,5 mm |

09S-067



Down-Ward

| 4,5 mm |

09S-066

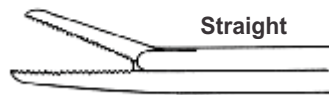

Straight

| 8,5 mm |



| 0,8 mm

09S-069

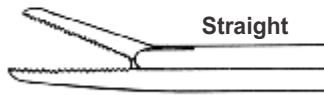

Straight

| 8,5 mm |



| 1,8 mm

09S-068



Micro Ear Forceps

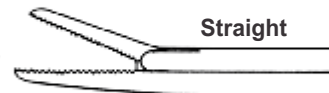

Straight

| 4,0 mm |



| 0,6 mm

09S-071

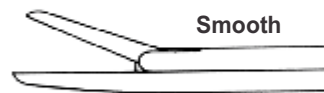

Smooth

| 4,0 mm |



| 0,6 mm

09S-070



09S

E.N.T INSTRUMENTS

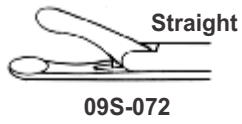

09S-072

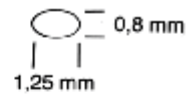

09S-073

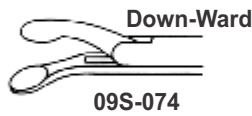

09S-074



09S-075

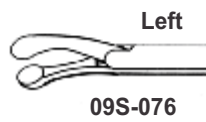

09S-076



Micro Ear Forceps

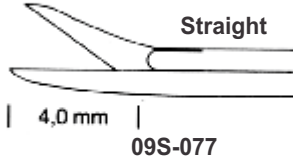

09S-077

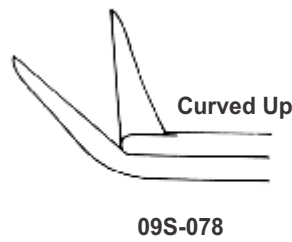

09S-078

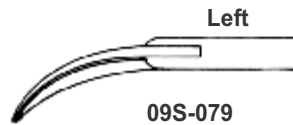

09S-079

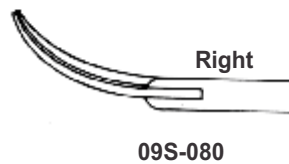

09S-080



Bellucci Micro Ear Forceps

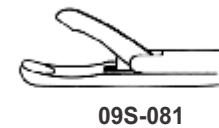

09S-081



Crura-Nipper Micro Ear Forceps

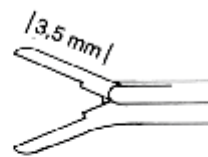

09S-082

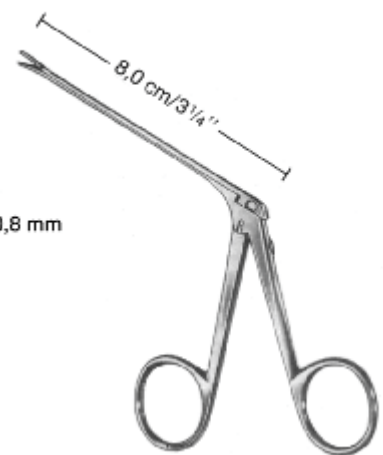

McGEE Ear Forceps



09S

E.N.T INSTRUMENTS



09S-083
Hartmann-Wullstein



09S-084
Hartmann-Wullstein



ARTICLE #	SHAFT
09S-085	3 1/2" (8.5cm)
09S-086	5 1/2" (14 cm)

Hartmann



ARTICLE #	SHAFT
09S-088	3 1/2" (8.5cm)
09S-089	5 1/2" (14 cm)

Hartmann



09S-090
Hartmann-Noyes



09S-091
Duckbill



09S-092
Weingartner



ARTICLE #	CUP
09S-093	2.0mm
09S-094	2.5mm
09S-095	3.0mm

Hartmann



ARTICLE #	CUP
09S-096	2.0mm
09S-097	2.5mm
09S-098	3.0mm

Hartmann



09S-099
Stropel



09S-100
Hartmann

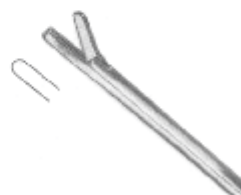

09S-101
Hartmann



09S-102
Hartmann-Hoffmann



09S

E.N.T INSTRUMENTS



09S-103
Hartmann
4 3/4" (12 cm)

09S-104
Hartmann
5 1/2" (14 cm)

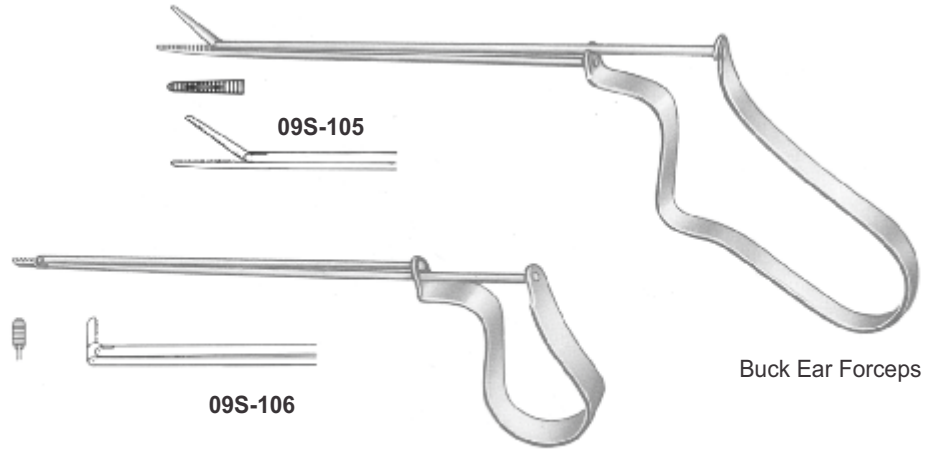

09S-105

09S-106

Buck Ear Forceps

Quire Ear Forceps



ARTICLE #	SIZE
09S-107	6 1/4" (16 cm)
09S-108	8" (20 cm)

Hartmann



09S-109
Heymann-Knight Nasal
Polypus Forceps 7" (18 cm)



09S-110
Lubet-Barbon
8" (20 cm)



09S-111 Killian
6 3/4" (17 cm)



09S-112

09S-113

Westmacott
8" (20 cm)



09S-114
Hartmann Nasal
Polypus Forceps 7 1/2"
(19 cm)



E.N.T INSTRUMENTS

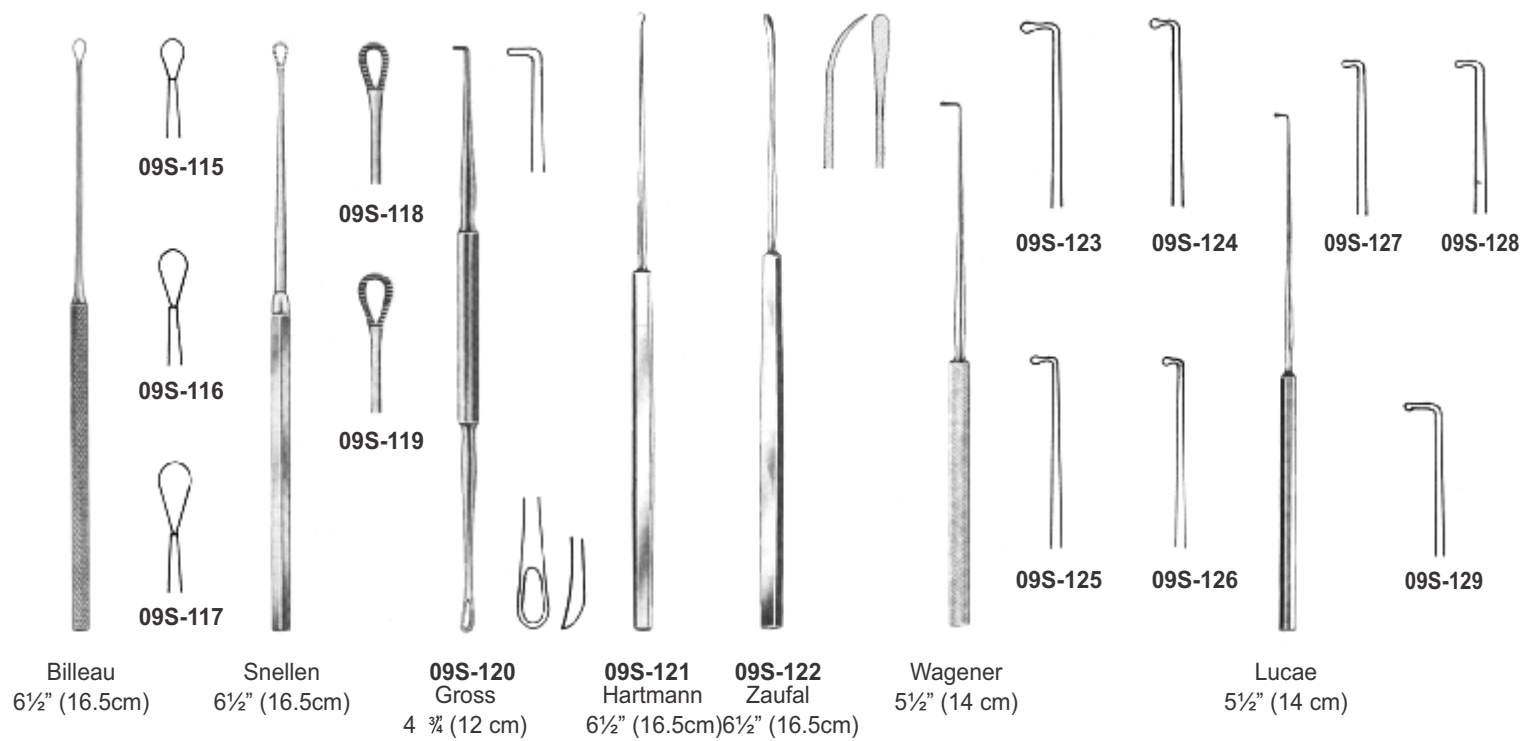

Billeau 6½" (16.5cm) **Snellen** 6½" (16.5cm) **09S-120** Gross 4 ¾" (12 cm) **09S-121** Hartmann 6½" (16.5cm) **09S-122** Zaufal 6½" (16.5cm) **Wagener** 5½" (14 cm) **Lucae** 5½" (14 cm)

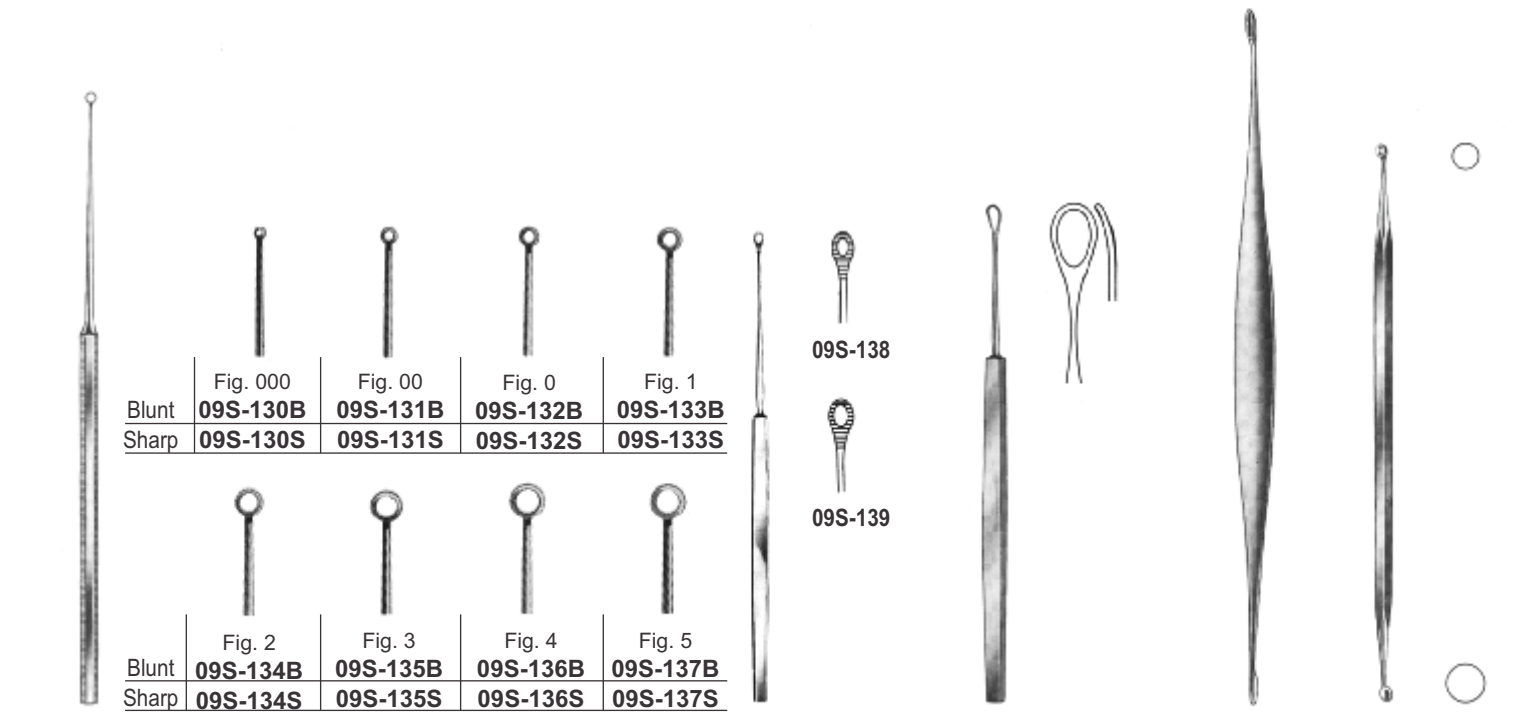

Buck 6½" (16.5cm) **Shapleigh** 5¼" (13 cm) **09S-140** Langenbeck 5 ¼" (13 cm) **09S-141** Barth 7" (18 cm) **09S-142** Jansen 6" (15 cm)



09S

E.N.T INSTRUMENTS



NEWMAX CORPORATION

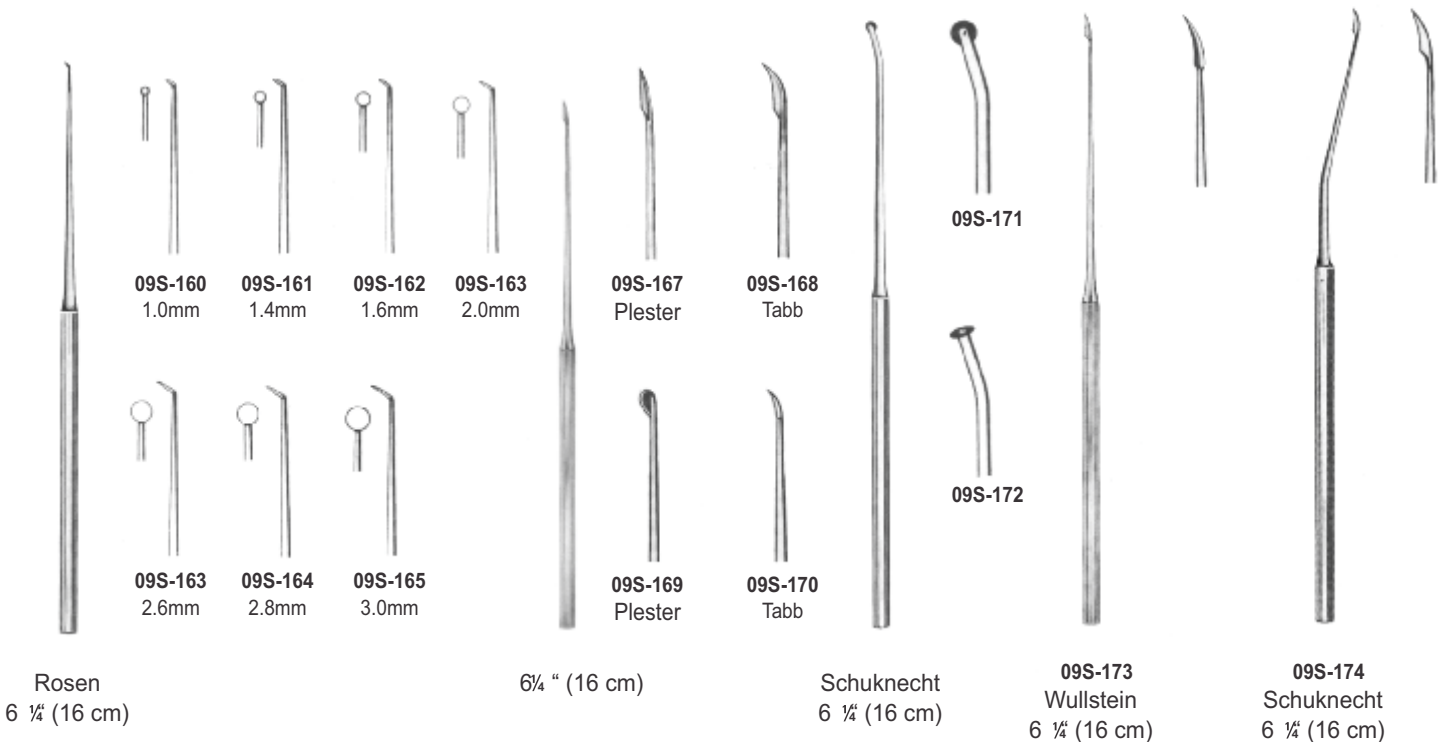
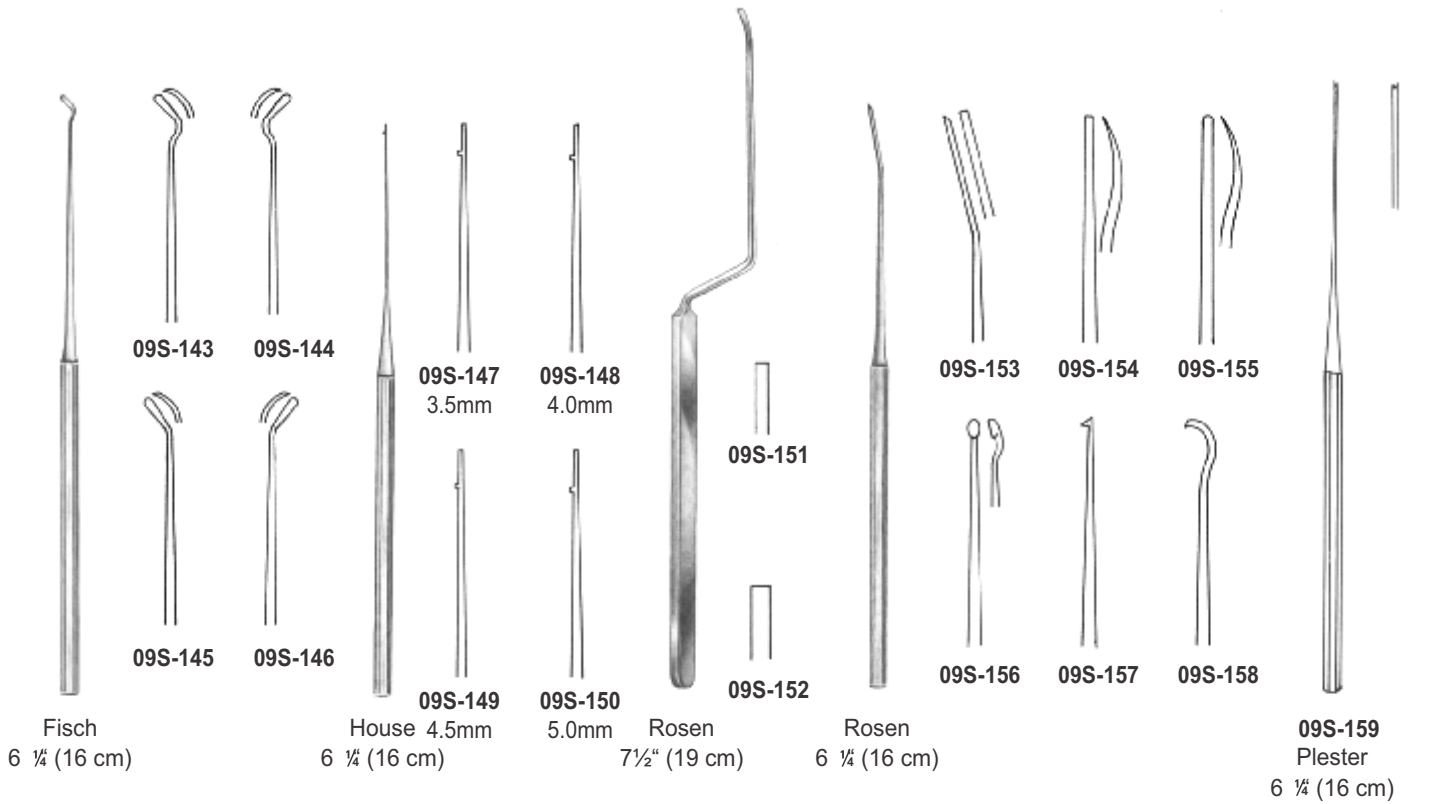



09S

E.N.T INSTRUMENTS



NEWMAX CORPORATION



1.0mm



1.5mm



1.5 x 2.5mm



1.5 x 2.5mm



09S-181
Buckingham



09S-182
Larkin



09S-183
Buckingham



09S-184
Larkin



09S-185
Buckingham



09S-186
Larkin

Foot Plate Hand Instruments
6 1/4" (16 cm)

09S-175

House

09S-176

House

09S-179

Shear

09S-180

Shear

Foot Plate Hand
Instruments 6"(15 cm)

Foot Plate Hand
Instruments 6"(15 cm)

Foot Plate
Hand Instruments
6 1/4" (16 cm)

Foot Plate Hand
Instruments 6 1/4"
(16 cm)

Fig.0
09S-187

Fig.00
09S-188

Fig.000
09S-189

Fig.0000
09S-190

Fig.00000
09S-191

09S-192
2.2mm

09S-193
3.2mm

3mm

09S-196
2mm

09S-198
4mm

09S-197
3mm

09S-199
5mm

Lempert Curettes
8 1/4 (21 cm)

Wullstein Curettes
6 1/4 (16 cm)

09S-194
Lempert Curettes
6 1/4 " (16 cm)

09S-195
Shambaugh-
Derlacki Curettes
6 1/4 " (16 cm)

Lempert Curettes
6 3/4 (17 cm)



09S

E.N.T INSTRUMENTS

Straight



Curved



3 mm





4 mm





5 mm











	09S-200	09S-201	09S-202
Straight			
Curved	09S-203	09S-204	09S-205

09S-206
Joseph-Masing
8 3/4"(22 cm)

09S-207
Halle
Periosteal
Elevators
6 1/2"(16.5cm)

09S-208
Joseph
Periosteal
Elevators
6 1/2"(16.5cm)

Ballenger Spetum Knives
8"(20 cm)

09S-206
Joseph-Masing
8 3/4"(22 cm)

09S-207
Halle
Periosteal
Elevators
6 1/2"(16.5cm)

09S-208
Joseph
Periosteal
Elevators
6 1/2"(16.5cm)

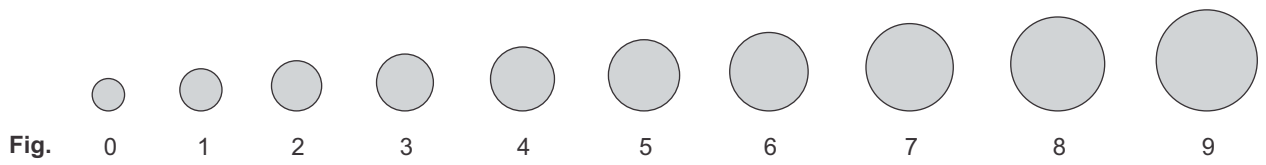
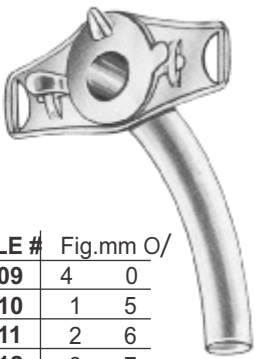
ARTICLE #	Fig.	mm O/
09S-209	4	0
09S-210	1	5
09S-211	2	6
09S-212	3	7
09S-213	4	8
09S-214	5	9
09S-215	6	10
09S-216	7	11
09S-217	8	12
09S-218	9	13

Luer

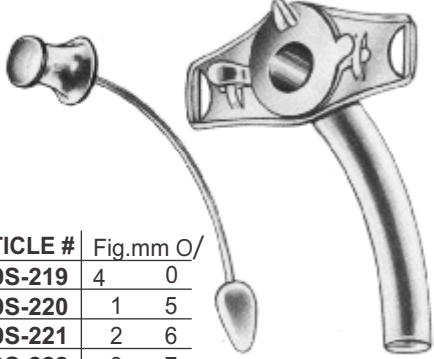

ARTICLE #	Fig.	mm O/
09S-219	4	0
09S-220	1	5
09S-221	2	6
09S-222	3	7
09S-223	4	8
09S-224	5	9
09S-225	6	10
09S-226	7	11
09S-227	8	12
09S-228	9	13

Chevalier-Jackson



09S

E.N.T INSTRUMENTS



09S-239
Krause Nasal
Snares 6 1/4"
(16 cm)



09S-240
Krause-Voss
Nasal Snares 6 1/4"
(16 cm)



09S-241
Lange-Wilde
Nasal Snares 6 1/4"
(16 cm)

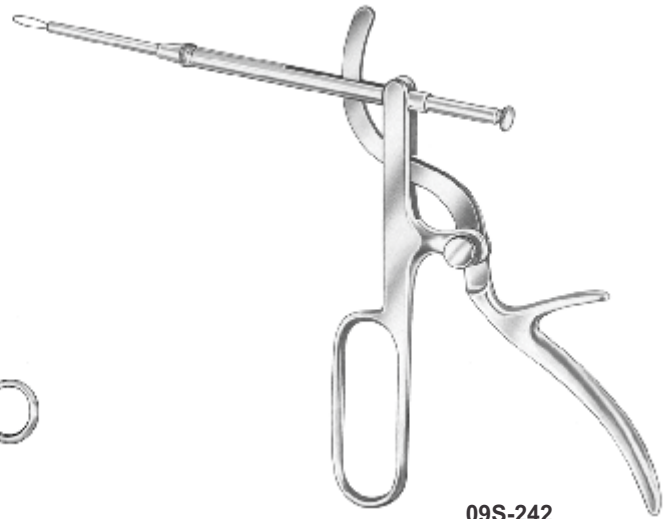

09S-242
Tonsil Snares



Hartmann
Otology
Instruments
5 1/2" (14 cm)

- 09S-243**
- 09S-244**
- 09S-245**
- 09S-246**
- 09S-247**
- 09S-248**



09S-249 - 09S-255
Frazier Suction
Tubes 7 1/2" (19 cm)



09S-256 - 09S-258
Baron Suction Tubes



09S-259
Suction
Tubes 11 1/4"
(30 cm)

ARTICLE #	Fr.
09S-249	6
09S-250	7
09S-251	8
09S-252	9
09S-253	10
09S-254	11
09S-255	12

ARTICLE #	Fr.
09S-256	3
09S-257	5
09S-258	7

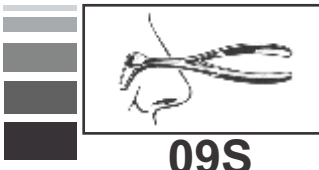

E.N.T INSTRUMENTS



Lewis
7" (18 cm)

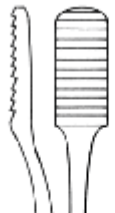

09S-260

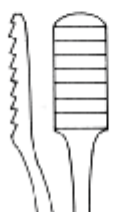

09S-261



09S-262
Cottle
8 1/4" (21 cm)

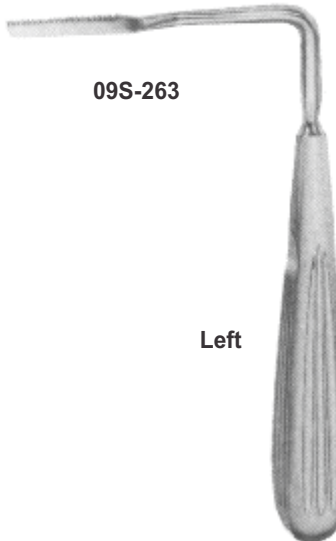

09S-263

Left

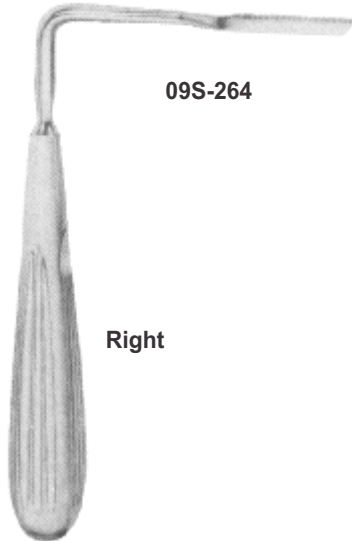

09S-264

Right

Joseph
6 3/4" (17 cm)



09S-265
Maltz
7" (18 cm)

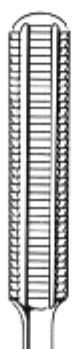

Joseph
7 1/2" (19 cm)



09S-266

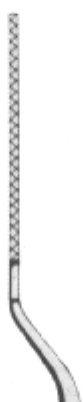

09S-267



09S-268



Aufrecht
8 1/4" (21 cm)



09S-269



09S-270



09S

E.N.T INSTRUMENTS



**09S-271-
09S-276**
Hartmann
Tuning Fork

09S-271	C 128
09S-272	C 256
09S-273	C 512
09S-274	C 1024
09S-275	C 2048
09S-276	C 4096



**09S-277-
09S-282**
Lucae
Tuning Fork

09S-277	C 128
09S-278	C 256
09S-279	C 512
09S-280	C 1024
09S-281	C 2048
09S-282	C 4096

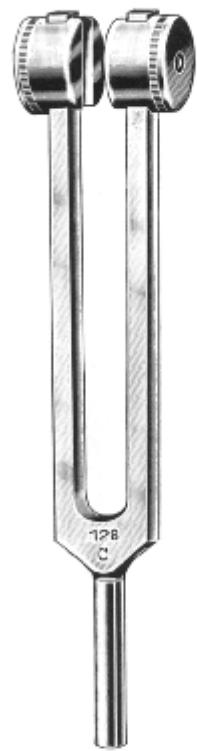

09S-283- 09S-285
Tuning Fork

09S-283	C 64
09S-284	C 128
09S-285	C 256



09S-286
Koenig
A-109
Tuning
Fork

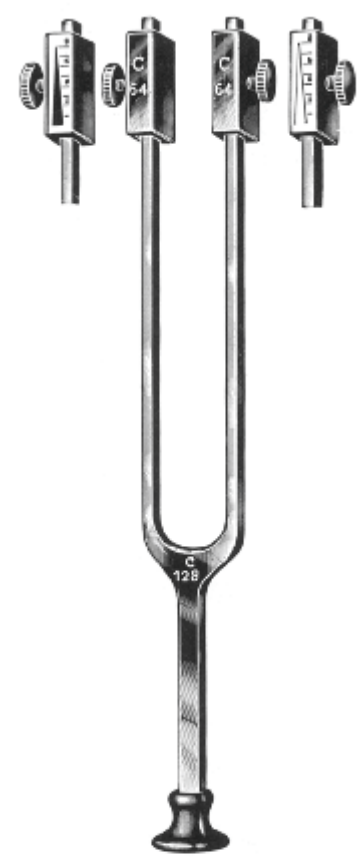

09S-287
Rydel-
Seiffer
C64/C12
8 Tuning
Fork

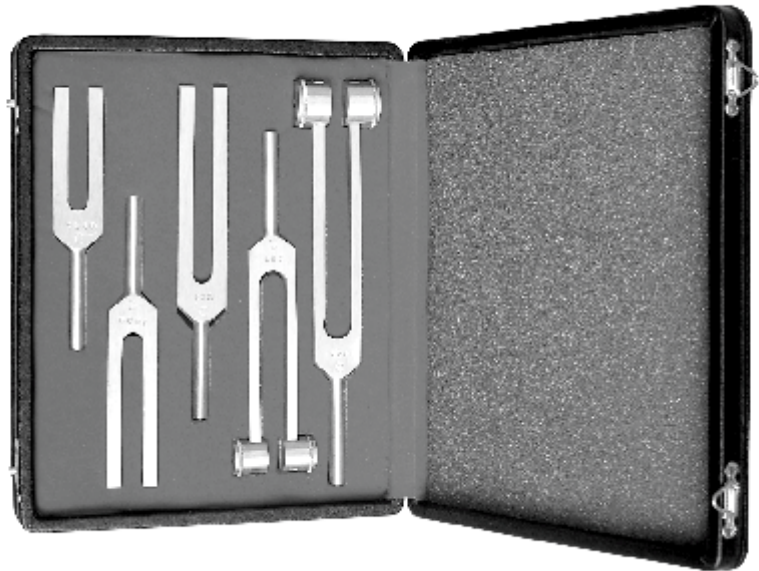

09S-288
Set of Tuning
Forks C 128
C 256
C 512
C 1024
C 2048



10S

NEURO SURGERY INSTRUMENTS



10S-001
Bone & Rib
Shears 9" (23
cm)



10S-002
Bone & Rib
Shears 8 " (22 cm)



10S-003
Gluck
Bone & Rib
Shears 8 " (22 cm)



10S-004
Brunner Sternum
Scissors 12½" (32 cm)



10S-005
Giertz-Stille
Sternum
Scissors
10½" (27 cm)



10S-006
Sauerb-Ruch
Sternum
Scissors 10¼"
(26 cm)

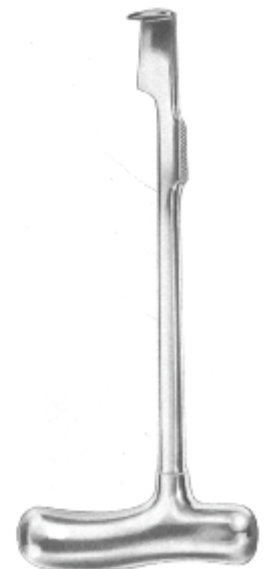

10S-007 Lebsche
Sternum Scissors
9¾" (25 cm)



10S

NEURO SURGERY INSTRUMENTS



Cooley Rib Spreader

Art.No	A	B	C	D
10S-008	20mm	45mm	140mm	110mm
10S-009	30mm	50mm	180mm	145mm
10S-010	30mm	50mm	200mm	145mm

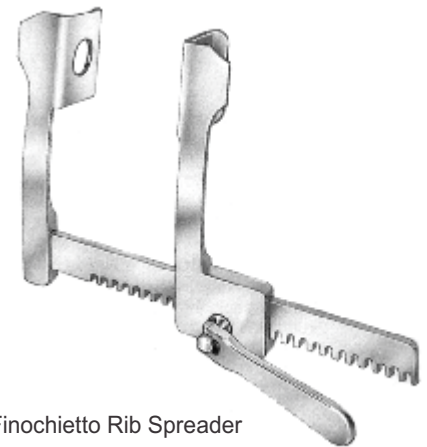
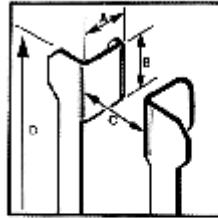

Finochietto Rib Spreader

Art.No	A	B	C	D
10S-011	30mm	45mm	140mm	110mm
10S-012	42mm	62mm	175mm	140mm
10S-013	75mm	65mm	200mm	140mm

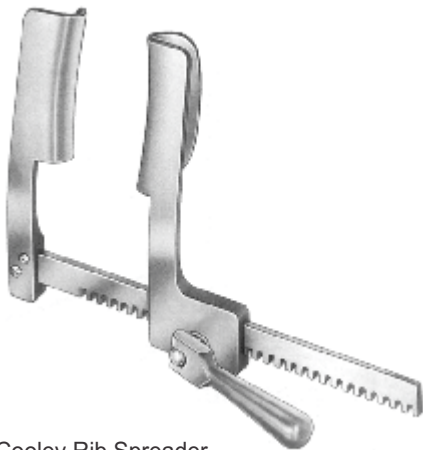

Cooley Rib Spreader

Art.No	A	B	C	D
10S-014	35mm	100mm	180mm	180mm
10S-015	35mm	115mm	230mm	205mm



Burford-Finochitto Rib Spreader

Art.No	A	B	C	D
10S-016	45mm	62mm	180mm	200mm
10S-017	45mm	62mm	250mm	200mm
10S-018	45mm	62mm	300mm	200mm

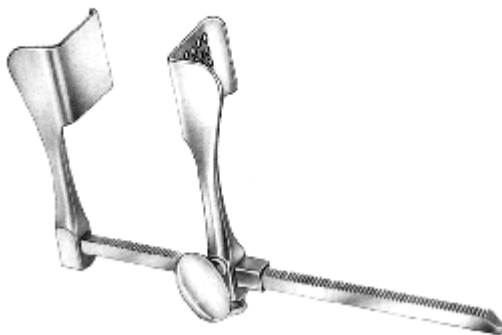

Tuffier Rib Spreader

Art.No	A	B	C	D
10S-019	42mm	45mm	170mm	110mm

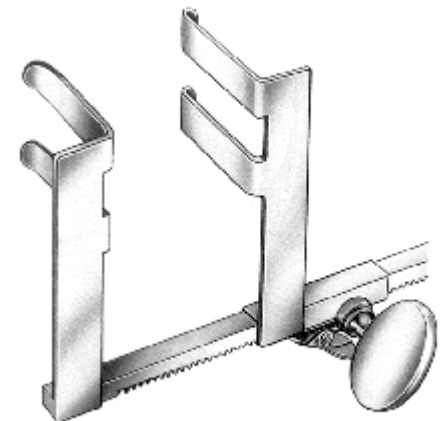

Mini Thoracotomy Rib Spreader

Art.No	A	B	C	D
10S-020	38mm	12mm	70mm	90mm



10S

NEURO SURGERY INSTRUMENTS

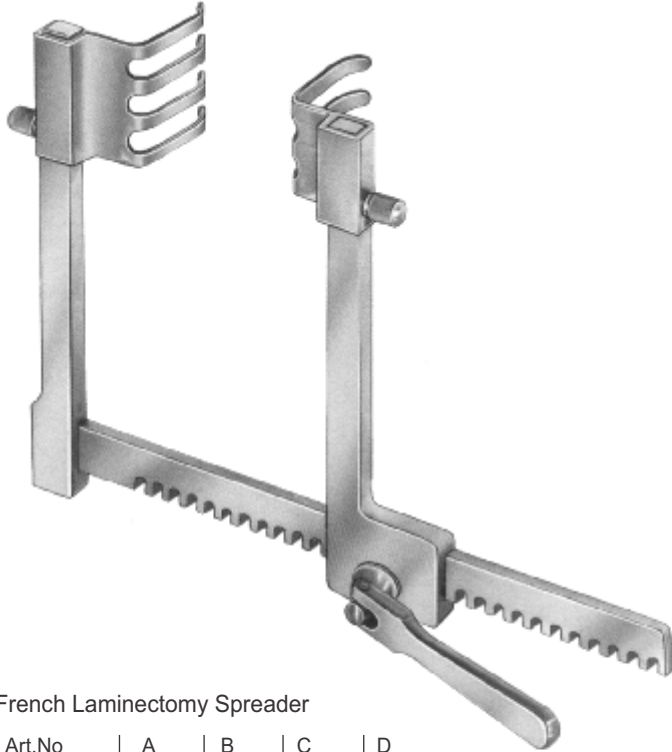

French Laminectomy Spreader

Art.No	A	B	C	D
10S-021	38mm	32mm	130mm	125mm

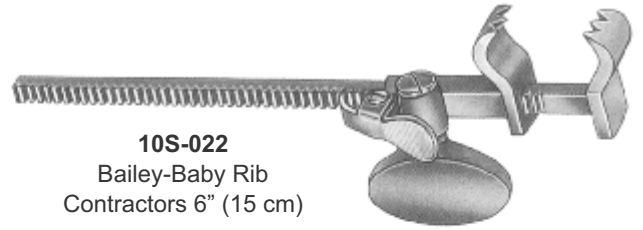

10S-022
Bailey-Baby Rib
Contractors 6" (15 cm)

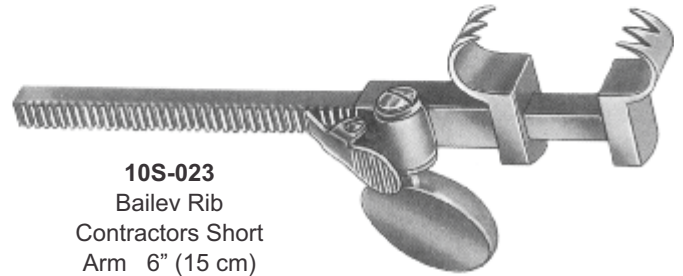

10S-023
Bailey Rib
Contractors Short
Arm 6" (15 cm)

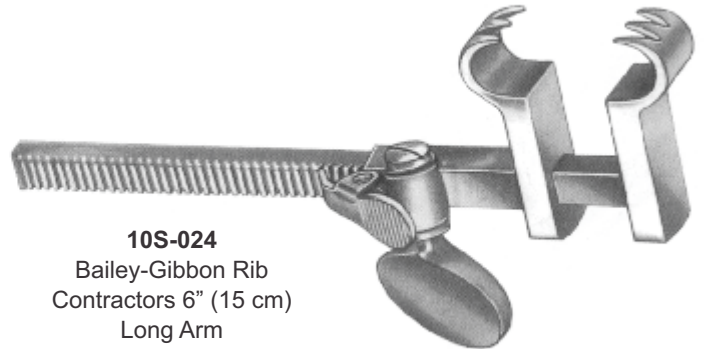

10S-024
Bailey-Gibbon Rib
Contractors 6" (15 cm)
Long Arm



10S-025
Casper Retractor for Spine



10S-026	50 x 25 mm
10S-027	60 x 25 mm



10S-033	40 x 23 mm
10S-034	45 x 23 mm
10S-035	50 x 23 mm
10S-036	55 x 23 mm
10S-037	60 x 23 mm



10S-028	40 x 23 mm
10S-029	45 x 23 mm
10S-030	50 x 23 mm
10S-031	55 x 23 mm
10S-032	60 x 23 mm

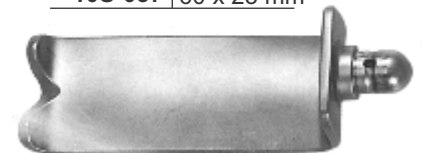

10S-038	45 x 23 mm
10S-039	50 x 23 mm
10S-040	55 x 23 mm
10S-041	60 x 23 mm
10S-042	65 x 23 mm



10S

NEURO SURGERY INSTRUMENTS



NEWMAX CORPORATION



10S-043
Crutchfield
Traction
Cervical Tongs
Small



10S-044
Crutchfield
Traction
Tongs
Medium



10S-045
3.5mm O/



10S-046
5mm O/



10S-047
Dahlgren Instruments
8" (20 cm)



10S-048
De Vilbiss Instruments
8 3/4" (21 cm)



10S-049
Large Lamina Spreader
10 3/4" (27 cm)



10S-050
Large Lamina
Spreader 6 1/2" (16 cm)



10S-051
Cloward Lamina
Spreader 6 1/2" (16 cm)

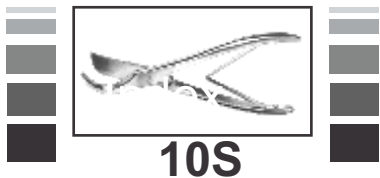

NEURO SURGERY INSTRUMENTS



ARTICLE #	SIZE
10S-052	6" (15 cm)
10S-053	7½" (19 cm)

McKenzie
Clip Applying
Forceps
Curved

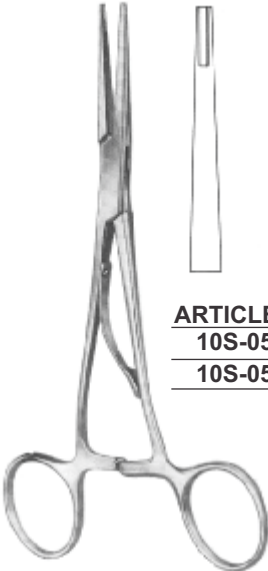

ARTICLE #	SIZE
10S-054	6" (15 cm)
10S-055	7½" (19 cm)

McKenzie
Clip Applying
Forceps
Straight



10S-056 Raney
Hemostatic Clip Applying
Forceps 6" (15 cm)



120 mm, 4 3/4"

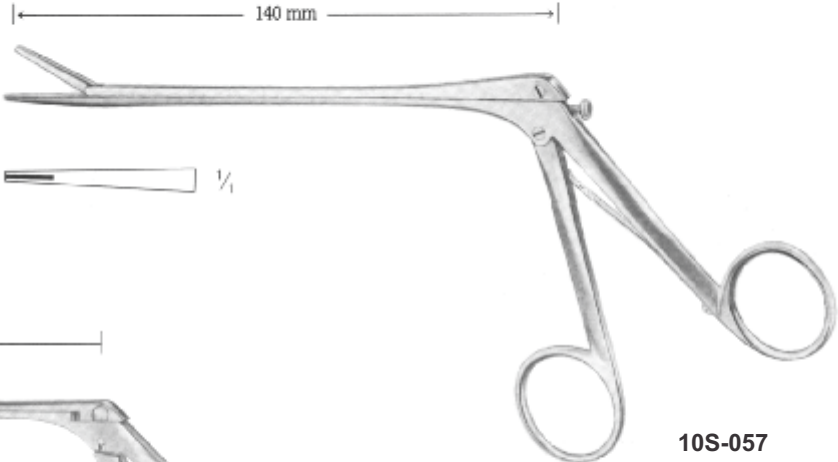

10S-057
Oliveerona-
Toennis
(Scoville) 5.5"
(14 cm)

Art No.	Jaw Size (mm)	Jaw	Length (in.)
10S-058	3.00	STR	4¾ (12 cm)
10S-059	3.6	STR	4¾ (12 cm)
10S-060	4.2	STR	4¾ (12 cm)
10S-061	4.8	STR	4¾ (12 cm)
10S-062	5.8	STR	4¾ (12 cm)
10S-063	3.6	140°UP- CVD	4½ (11.5 cm)
10S-064	4.2	140°UP- CVD	4½ (11.5 cm)
10S-065	4.8	140°UP- CVD	4½ (11.5 cm)

10S-058 to 10S-065
Weil-Blakesley Roungeur



10S

NEURO SURGERY INSTRUMENTS

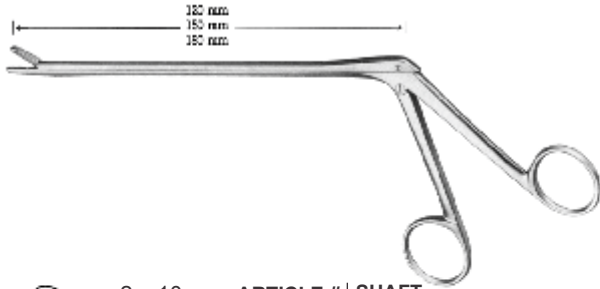

2 x 10 mm	ARTICLE #	SHAFT
	10S-084	120 mm
	10S-085	150 mm
	10S-086	180 mm

3 x 10 mm	ARTICLE #	SHAFT
	10S-087	120 mm
	10S-088	150 mm
	10S-089	180 mm

4 x 10 mm	ARTICLE #	SHAFT
	10S-090	120 mm
	10S-091	150 mm
	10S-092	180 mm

ARTICLE #	SHAFT	2 x 10 mm / 45°
10S-093	120 mm	
10S-094	150 mm	
10S-095	180 mm	

ARTICLE #	SHAFT	3 x 10 mm / 45°
10S-096	120 mm	
10S-097	150 mm	
10S-098	180 mm	

ARTICLE #	SHAFT	4 x 10 mm / 45°
10S-099	120 mm	
10S-100	150 mm	
10S-101	180 mm	

2 x 10 mm / 45°	ARTICLE #	SHAFT
	10S-102	120 mm
	10S-103	150 mm
	10S-104	180 mm

3 x 10 mm / 45°	ARTICLE #	SHAFT
	10S-105	120 mm
	10S-106	150 mm
	10S-107	180 mm

4 x 10 mm / 45°	ARTICLE #	SHAFT
	10S-108	120 mm
	10S-109	150 mm
	10S-110	180 mm

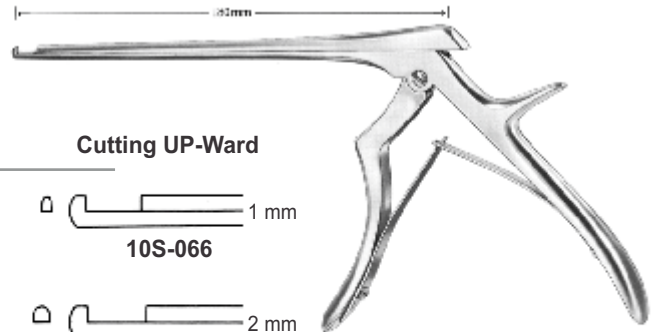

Cutting UP-Ward

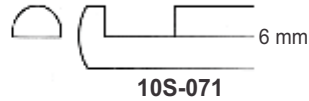
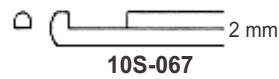
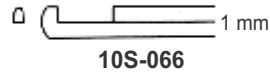

Cutting 40° Angle

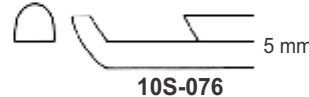
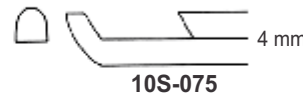
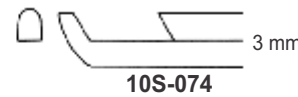
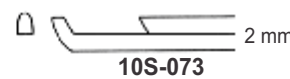
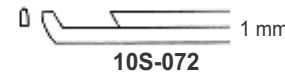

Ferris-Smith-Kerrison

Cutting Down-Ward

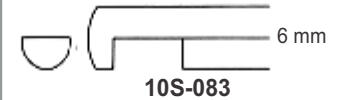
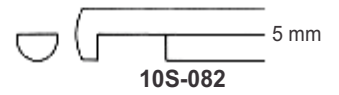
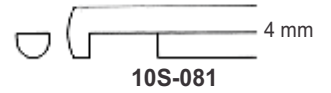
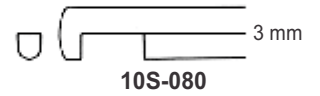
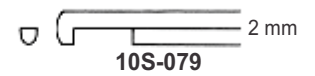
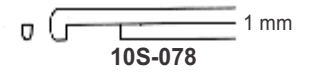



11S

BONE SURGERY INSTRUMENTS



NEWMAX CORPORATION



11S-001
Bone Hand
Drills 5 1/2"
(14 cm)



11S-002
Bone Hand
Drills 5 1/2"
(14 cm)



11S-003
Moore Hand Drills



11S-004
9 cm
Ø 3,2mm



11S-005
7 cm
Ø 3,2mm



11S-006
Hudson Bone
Hand Drills 10"
(27 cm)



11S-007
9 mmØ



11S-008
14 mmØ



11S-009
16 mmØ



11S-010
22 mmØ



11S-011
Cushing
14 mmØ



11S-012
2 mmØ



11S-013
McKenzie
13 mmØ



11S-014
Errico
16 mmØ



11S

BONE SURGERY INSTRUMENTS



11S-015
Gigli Saw Handle



11S-016
Gigli Strully Saw Handle



11S-017
Gigli Strully Saw Handle



11S-018
Gigli Strully Saw Handle

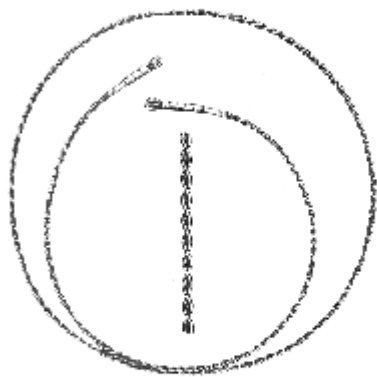

Gigli Saw Wire

ARTICLE #	SIZE
11S-019 A	12" (30 cm)
11S-019 B	20" (51 cm)
11S-019 C	30" (76 cm)



Saw
Blade
11S-020
15mm



11S-021
Charriere
Resection Saw
14" (35 cm)



11S-022
Langenbeck
Saw 9" (23 cm)

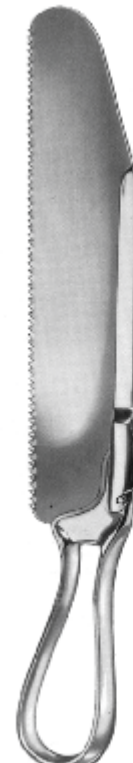

11S-023
Charriere
Saw 10½"
(27 cm)



11S-024
Satterlee
Saw 13 ¼"
(31 cm)



11S

BONE SURGERY INSTRUMENTS



NEWMAX CORPORATION



- Fig, 000
11S-025
- Fig, 00
11S-026
- Fig, 0
11S-027
- Fig, 1
11S-028
- Fig, 2
11S-029
- Fig, 3
11S-030
- Fig, 4
11S-031

Schede Bone Curettes
6½" (16 cm)



- Fig, 0000
11S-032
- Fig, 000
11S-033
- Fig, 00
11S-034
- Fig, 0
11S-035
- Fig, 1
11S-036
- Fig, 2
11S-037
- Fig, 3
11S-038
- Fig, 4
11S-039
- Fig, 5
11S-040
- Fig, 6
11S-041

Volkmann Bone Curettes
6½" (16 cm)



- Fig, 0000
11S-042
- Fig, 000
11S-043
- Fig, 00
11S-044
- Fig, 0
11S-045
- Fig, 1
11S-046
- Fig, 2
11S-047
- Fig, 3
11S-048
- Fig, 4
11S-049
- Fig, 5
11S-050
- Fig, 6
11S-051

Bruns Bone Curettes
6½" (16 cm)



- Fig, 0000
11S-052
- Fig, 000
11S-053
- Fig, 00
11S-054
- Fig, 0
11S-055
- Fig, 1
11S-056
- Fig, 2
11S-057
- Fig, 3
11S-058
- Fig, 4
11S-059
- Fig, 5
11S-060

Spratt Bone Curettes
6½" (16 cm)



11S

BONE SURGERY INSTRUMENTS



NEWMAX CORPORATION

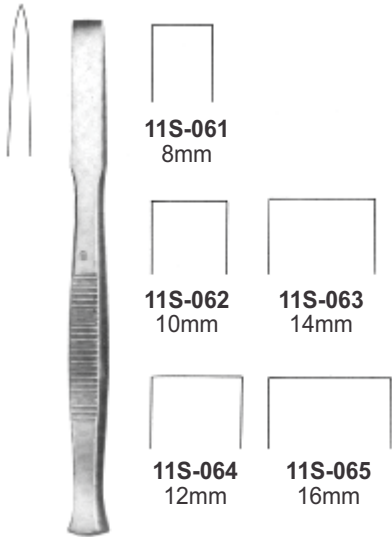

Bone Chisels
5 1/4" (13,5cm)

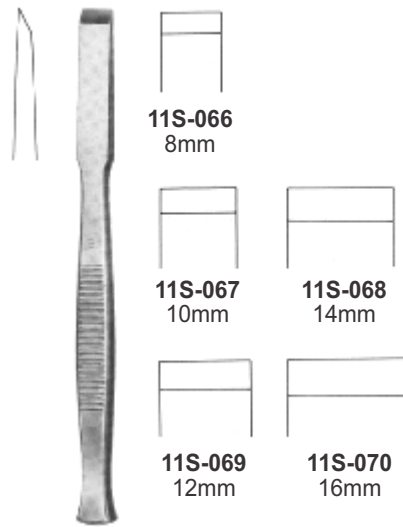

Bone Chisels
5 1/4" (13,5cm)

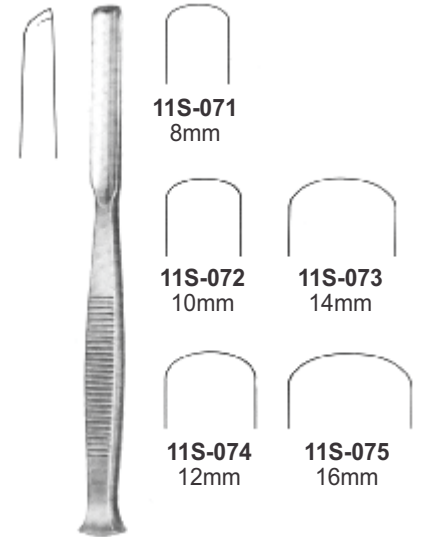

Bone Gouge
5 1/4" (13,5cm)

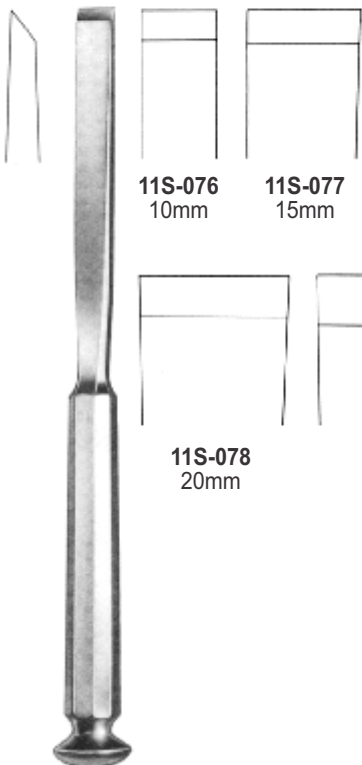

Stille Bone Chisels
8" (20 cm)

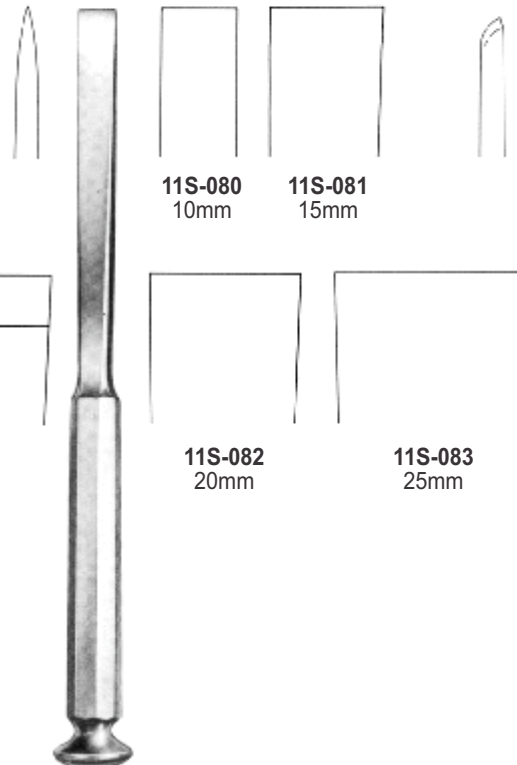

Stille Bone Chisels
8" (20 cm)

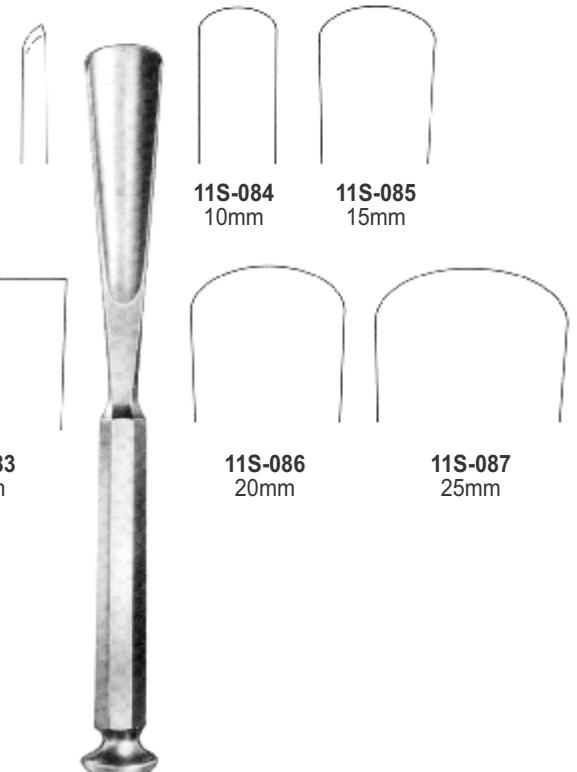

Stille Bone Gouge
8" (20 cm)



11S

BONE SURGERY INSTRUMENTS



NEWMAX CORPORATION



11S-088
26mm Ø
300 g (10½ oz.)

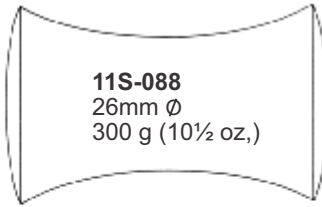

11S-089
28mm Ø
340 g (12 oz.)

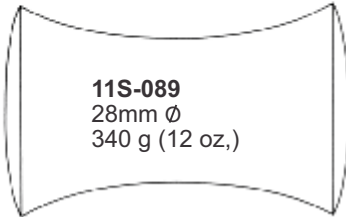

11S-090
30mm Ø
400 g (14 oz.)

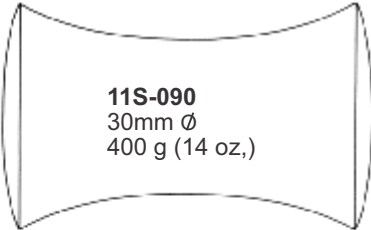

Williger Hammer
9½" (24 cm)



Head Weight
227 G

11S-091
Gerog Mallet Hammer
Weight



Doyen Hammer
8 ¼" (21 cm)

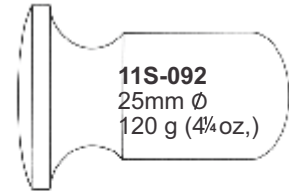

11S-092
25mm Ø
120 g (4¼ oz.)

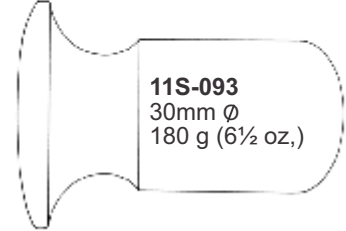

11S-093
30mm Ø
180 g (6½ oz.)

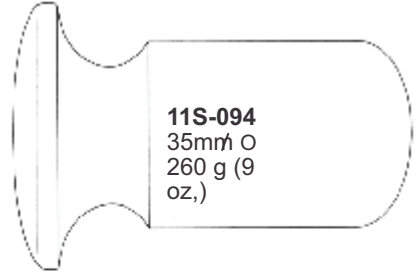

11S-094
35mm Ø
260 g (9 oz.)



11S-095
220 g (7¾ oz.)

Collin Hammer
8" (20 cm)



Lucae Hammer
7½" (19 cm)

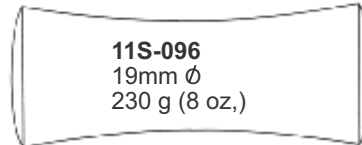

11S-096
19mm Ø
230 g (8 oz.)

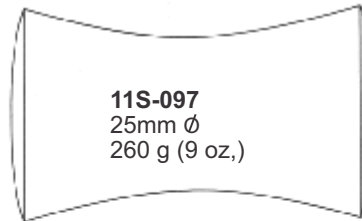

11S-097
25mm Ø
260 g (9 oz.)



Head Weight
450 G

11S-098
Miltex Mallet
11" (27,9cm)



11S

BONE SURGERY INSTRUMENTS

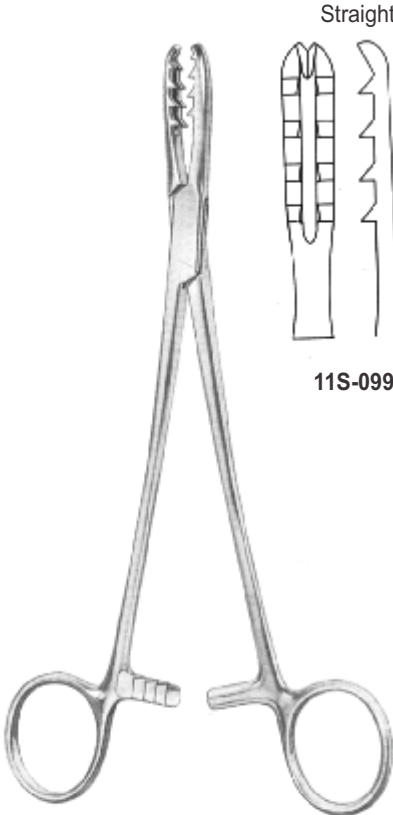

Bircher-Ganske Forceps
8" (20 cm)

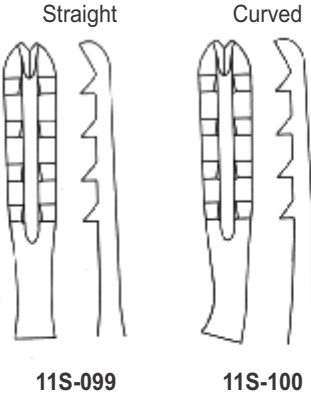

11S-101
Lewin
7" (17,5 cm)



11S-102
Bone Holding Forceps
5 ¼ (13,5cm)

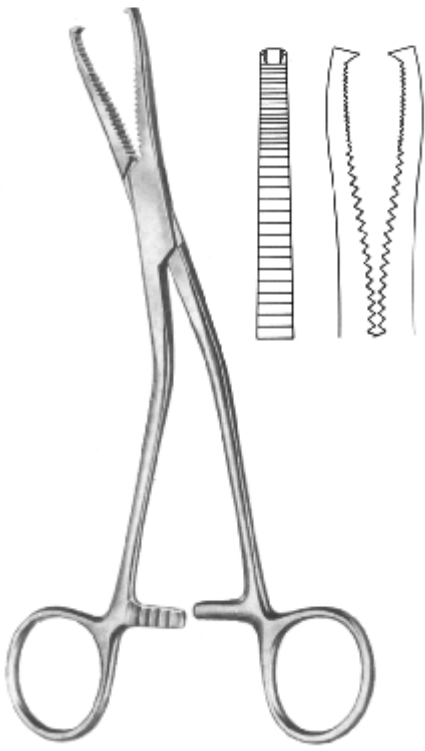

11S-103 Dingmann Bone
Forceps 7½" (19 cm)



11S-104
Martin Bone Forceps 7½" (19 cm)



11S

BONE SURGERY INSTRUMENTS



NEWMAX CORPORATION



11S-105
Bone Holding Forceps
5 1/2" (14 cm)



11S-106
Bone Holding Forceps
5 1/4" (13,5cm)



11S-107
Langenbeck
Bone Holding
Forceps 8 1/4" (21
cm)

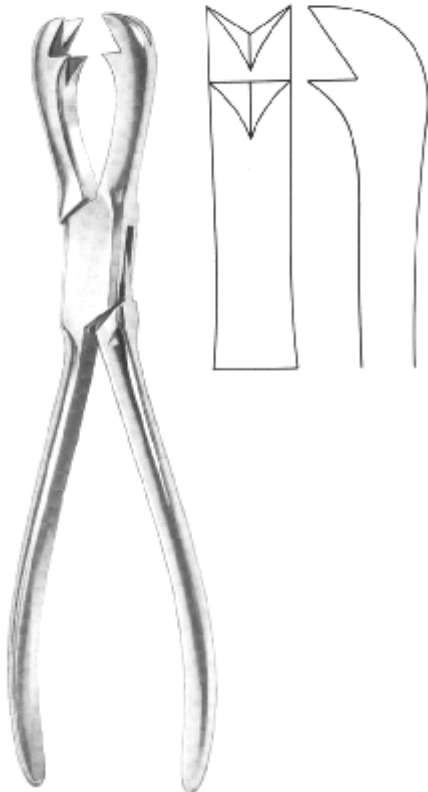

11S-108
Fergusson Bone Holding
Forceps 8 1/4" (21 cm)



11S-109
Frosch Bone Holding
Forceps 7" (18 cm)



11S-110
Bone Holding
Forceps 8" (20 cm)



11S

BONE SURGERY INSTRUMENTS



NEWMAX CORPORATION

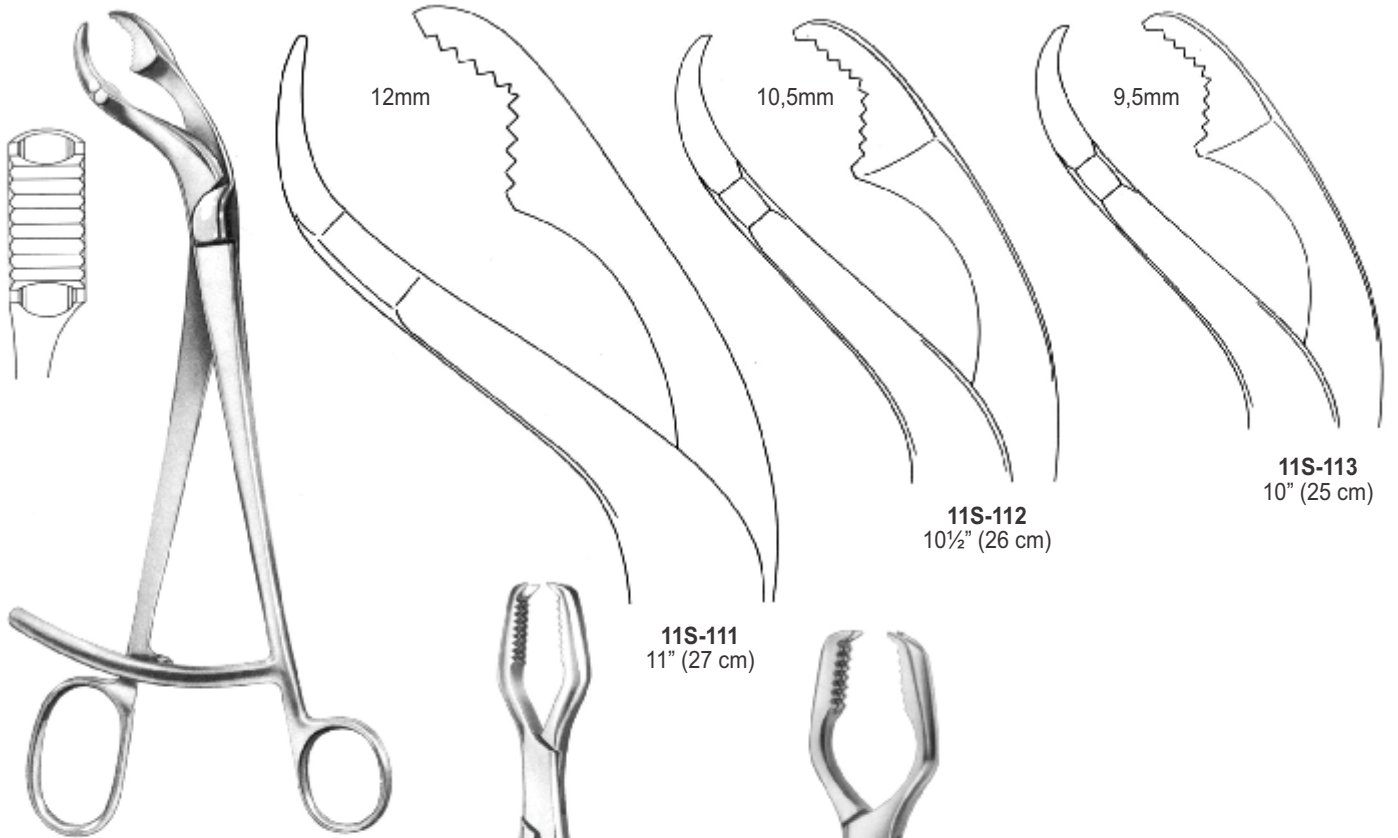

12mm

10,5mm

9,5mm

11S-111
11" (27 cm)

11S-112
10½" (26 cm)

11S-113
10" (25 cm)

Verbrugge Bone Holding Forceps



5 mm

11S-114
Verbrugge Bone Holding Forceps
6 ¾" (17,5cm)



11S-115
LANE Bone Holding
Forceps 13" (33 cm)



11S-116
LANE Bone Holding
Forceps 13" (33 cm)



11S-117
Lowmann Bone Holding
Forceps 7" (18 cm)



11S

BONE SURGERY INSTRUMENTS



NEWMAX CORPORATION



Kern Bone Holding Forceps

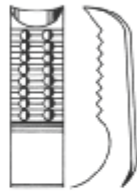

11S-118
6 3/4" (17 cm)

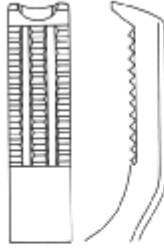

11S-119
8 1/4" (21 cm)



11S-120
Semb Bone Holding Forceps
7 1/2" (19 cm)

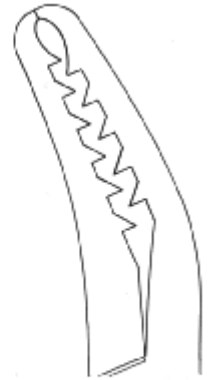

Farabeuf Bone Holding Forceps

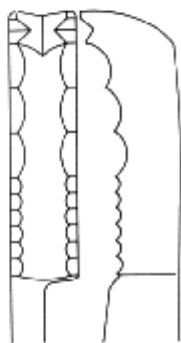

ARTICLE #	SIZE
11S-121	9" (23 cm)
11S-122	10 1/4" (26 cm)

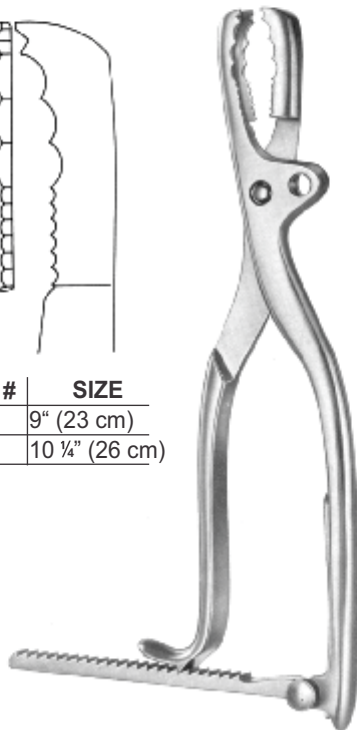

11S-123
Farabeuf-Lambotte
Bone Holding Forceps
10 1/4" (26 cm)

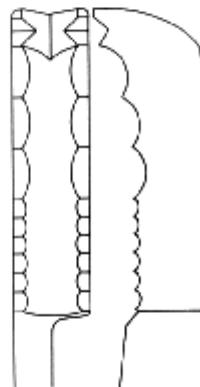

Lambotte Bone Holding Forceps

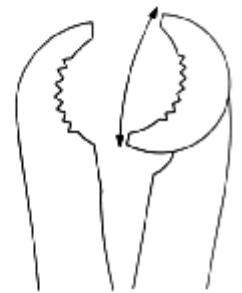

ARTICLE #	SIZE
11S-124	8" (22 cm)
11S-125	10 1/2" (27 cm)
11S-126	12" (30 cm)



11S

BONE SURGERY INSTRUMENTS



NEWMAX CORPORATION



11S-127
Hennig Spreader
11" (28cm)



11S-128
3 Prong Cast
Spreader 9" (23 cm)



11S-129
Eangle Saw



11S-130 7" (18 cm)
Wolfe Buechier Cast
Breaker

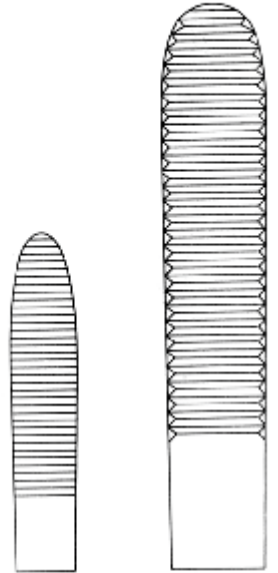

11S-131
10" (24 cm)



Stille- Cast Shears

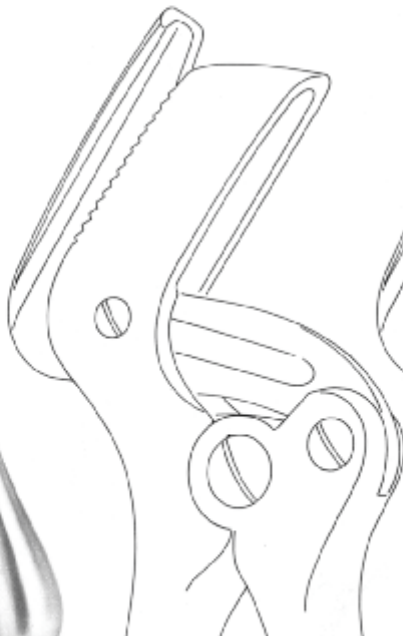

11S-132
8" (23 cm)

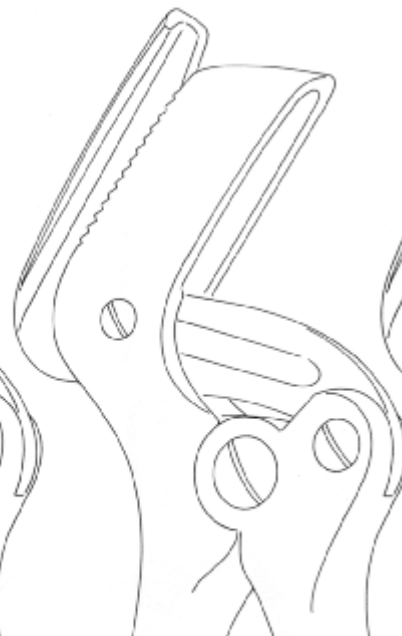

11S-133
11" (26 cm)

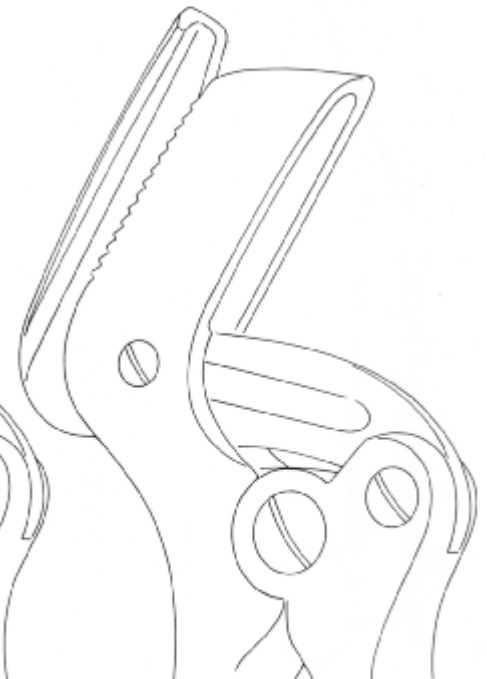

11S-134
15" (37 cm)



11S

BONE SURGERY INSTRUMENTS



11S-135



11S-136



11S-137



11S-138



11S-139



11S-140



11S-141

Blumenthal Bone Rongeur
6" (15 cm)

Luer Bone Rongeur
7" (15 cm)

Hartmann Bone Rongeur
7" (18,5cm)



11S-142



11S-143



11S-144



11S-145



11S-146



11S-147



Luer Bone Rongeur
7" (18 cm)

Jansen Bone Rongeur Forceps
7" (18 cm)

Lempert Bone Rongeur Forceps
7½" (19 cm)



11S

BONE SURGERY INSTRUMENTS



NEWMAX CORPORATION



11S-148
Ruskin Bone Rongeur Forceps
7" (18 cm)



11S-149
Ruskin Bone Rongeur Forceps
9" (23 cm)



11S-150
Stille-Ruskin
Bone Rongeur
Forceps 9" (23 cm)



11S-151
Stille Bone Rongeur Forceps
9" (23 cm)



11S-155

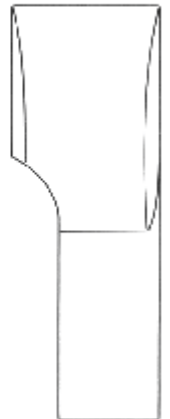

11S-158



11S-152



11S-153



11S-156



Echlin Bone Rongeur Forceps
9" (23 cm)



11S-154



Stille-Luer Bone Rongeur Forceps
8 3/4" (22 cm)



11S-157
Semb Bone Rongeur
Forceps 9" (23 cm)



Sauerbruch
Bone Rongeur
Forceps 12" (30 cm)

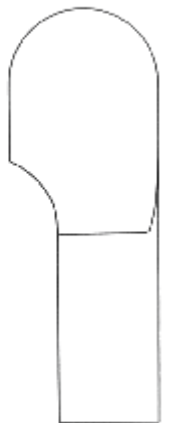

11S-159



11S

BONE SURGERY INSTRUMENTS



NEWMAX CORPORATION



Liston Bone Cutting Forceps
Straight



11S-160
5½" (14 cm)



11S-161
6¾" (17 cm)



11S-162
7½" (19 cm)



11S-163
8¾" (22 cm)



Liston Bone Cutting Forceps
Curved



11S-164
5½" (14 cm)



11S-165
6¾" (17 cm)



11S-166
7½" (19 cm)



11S-167
8¾" (22 cm)



11S-168
Rusking Bone Cutting Forceps
6" (15 cm)



11S-169
Markwalder Bone Cutting Forceps
8" (20 cm)



Ruskin-Liston
Bone Cutting Forceps
7½" (18,5cm)



11S-170



11S-171

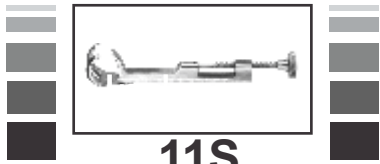

11S

BONE SURGERY INSTRUMENTS



11S-172
Cleveland
Bone Cutting
Forceps 7" (17
cm)

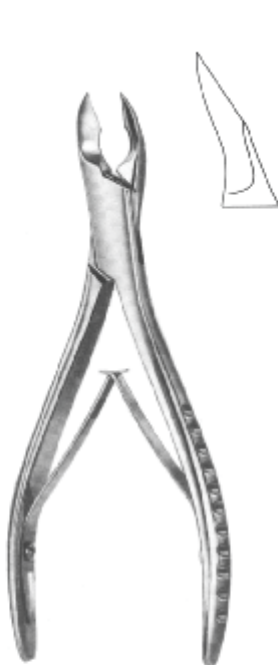

11S-173
Cleveland
Bone Cutting
Forceps 6" (15
cm)

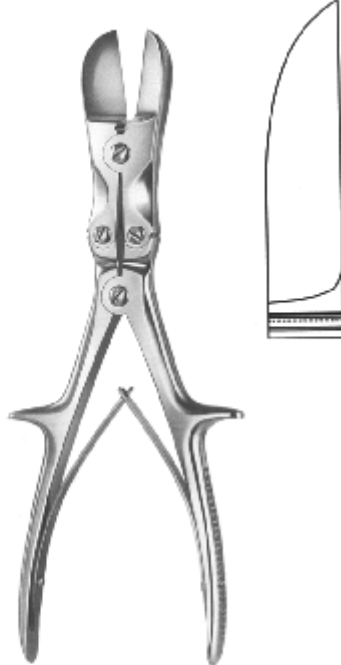

11S-174 Stille-Liston
Bone Cutting Forceps,
Straight 10½" (27 cm)

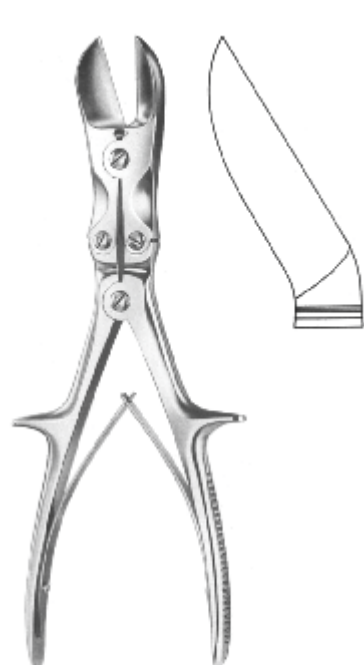

11S-175 Stille-Liston
Bone Cutting Forceps,
Curved 10½" (27 cm)

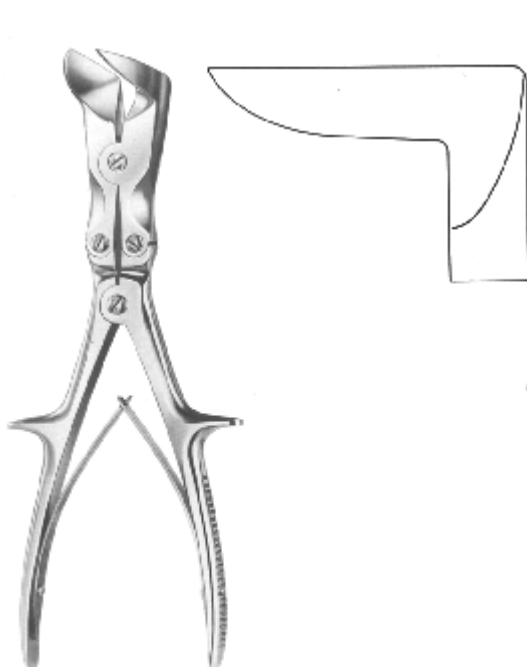

11S-177
Stille-Liston
Bone Cutting Forceps
10½", Curved

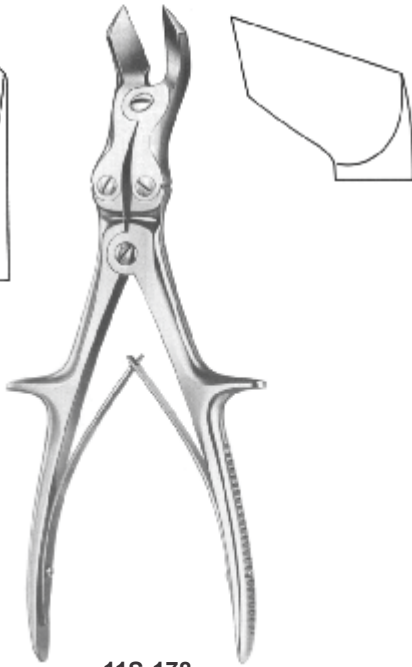

11S-178
Liston-Key
Bone Cutting
Forceps 10½"
(27 cm)

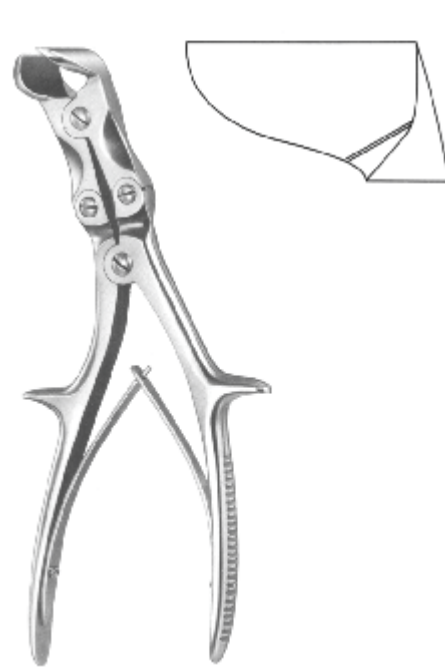

11S-179 Semb
Bone Cutting
Forceps 9½"
(24 cm)



11S

BONE SURGERY INSTRUMENTS



NEWMAX CORPORATION



11S-180
Flat Nose
Plier 6½"
(17 cm)

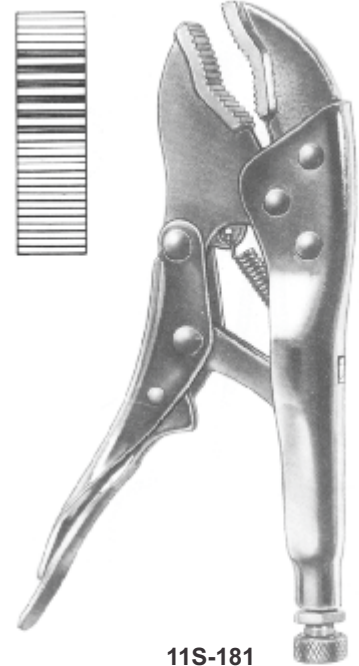

11S-181
Grip Plier
7" (18 cm)



11S-182
Wire Cutting
Plier 9" (23
cm)



11S-183
Bolt Cutter
12" (30 cm)



11S-184
Pin Cutter
18½" (47 cm)



11S

BONE SURGERY INSTRUMENTS



NEWMAX CORPORATION



11S-185
Wire Cutting Pliers
6" (16 cm)



11S-186
Diamant Wire Cutting
Pliers 6" (16 cm)



11S-187
Diamant Wire Cutting
Pliers 6" (15 cm)



11S-188
Flat Nose
Pliers 7"
(17 cm)



Flat Nose Pliers
7" (18 cm)



11S-189



11S-190



11S-191



Flat Nose Pliers
7" (18 cm)



11S-192

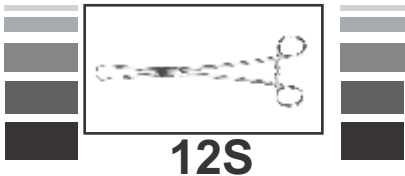

GYNACOLOGICAL & OBSTETRICAL INSTRUMENTS



12S-001
Pozzi Tenaculum Forceps 10" (25 cm)



12S-002
Schroeder Tenaculum Forceps 10" (25 cm)



12S-003
Barrett Tenaculum Forceps 7" (18 cm)



Meseux Tenaculum Forceps, Straight

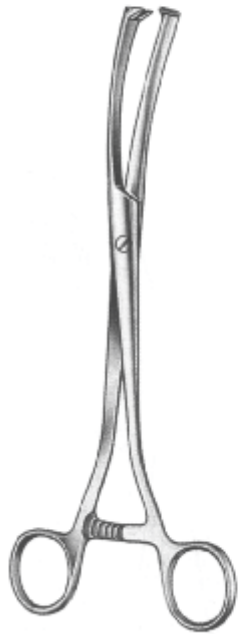

Meseux Curved Tenaculum Forceps

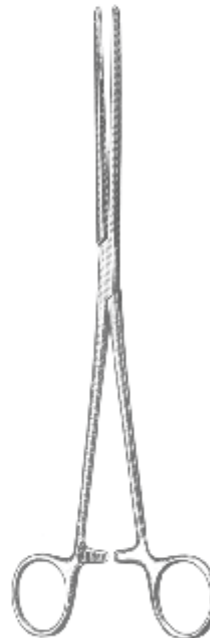

12S-010
Bozeman Uterine Dressing Forceps 10½" (26,5 cm)



12S-011
Bozeman Uterine Dressing Forceps 10½" (26,5 cm)

ARTICLE #	SIZE	WIDE AT TIP	ARTICLE #	SIZE	WIDE AT TIP
12S-004	9½" (24cm)	6 mm	12S-007	9½" (24cm)	6 mm
12S-005	9½" (24cm)	8 mm	12S-008	9½" (24cm)	8 mm
12S-006	9½" (24cm)	10 mm	12S-009	9½" (24cm)	10 mm

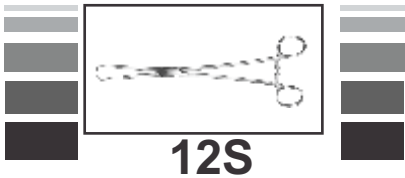

GYNACOLOGICAL & OBSTETRICAL INSTRUMENTS

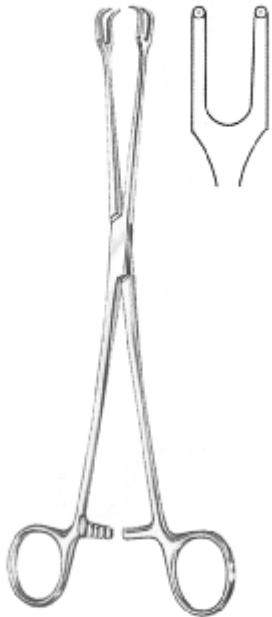

12S-012
Schroeder 2x2
Tenaculum Forceps 9½"
(24 cm)



12S-013
Schroeder 2x2
Curved Tenaculum
Forceps
9¾" (25 cm)



12S-014
Pratt Tenaculum
Forceps 10" (26 cm)



12S-015
Jacobs Tenaculum
Forceps 8¾" (21 cm)



12S-016
Jacobs Tenaculum
Forceps 8¾" (21 cm)



12S-017
Teale Tenaculum
Forceps 9" (23 cm)

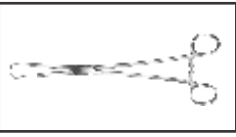

12S

GYNACOLOGICAL & OBSTETRICAL INSTRUMENTS



NEWMAX CORPORATION



Hegar Dilator, Single End

12S-018A	Set of 14 Pcs	14 to 17 mm
12S-018B	Set of 26 Pcs	1 to 26 mm

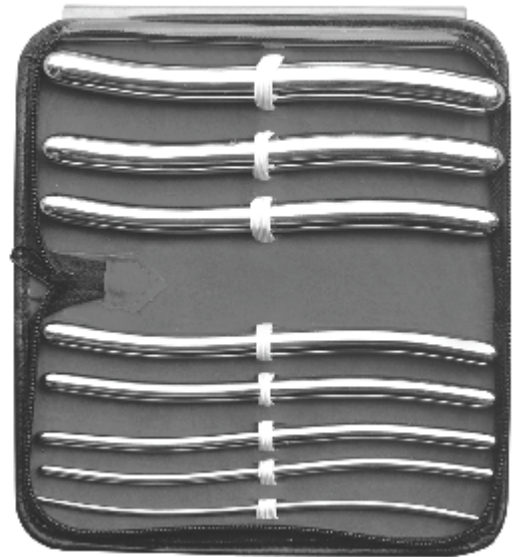

Hegar Dilator, Double End

12S-018C	Set of 8 Pcs	3/4 to 17/18 mm
12S-018D	Set of 13 Pcs	1/2 to 25/26 mm

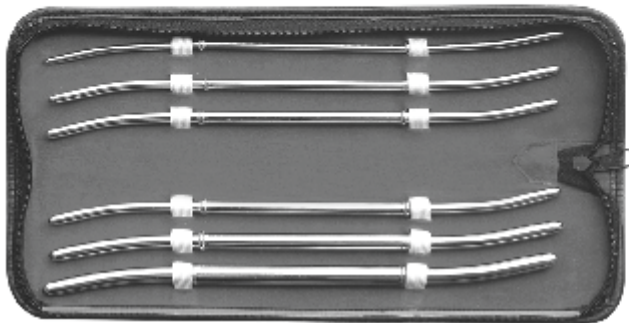

12S-018E

Hank Uterine Dilator
Set of 6 Pcs 9/10 to
19/20 FR

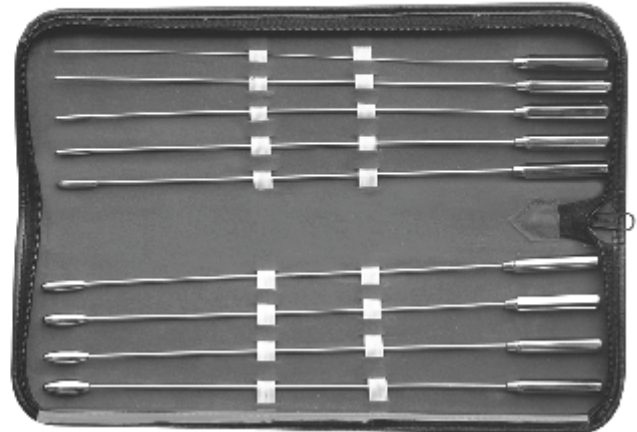

12S-018F

De-Bakey Vascular Dilator
Set of 9 Pcs, 2, 2.5, 3, 3.5, 4, 4.5, 5, 7,
9 mm

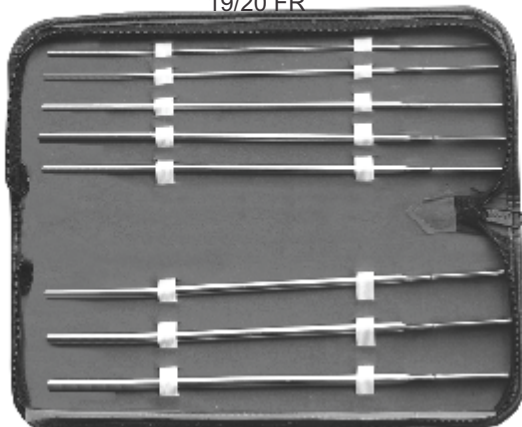

12S-018G

Dittel Sound Straight
Set of 8 Pcs,
8,10,12,14,16,18,20,22 FR

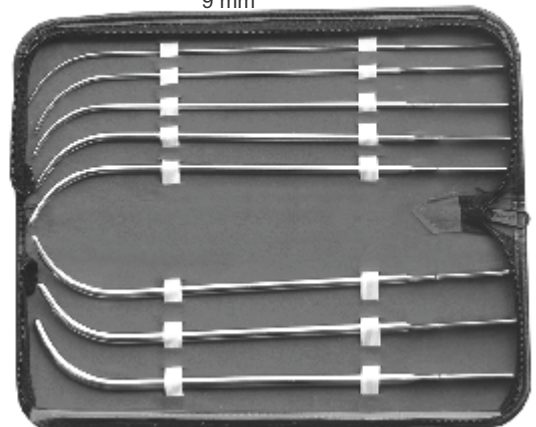

12S-018H

Van Buren Sound
Set of 8 Pcs,
8,10,12,14,16,18,20,22 FR

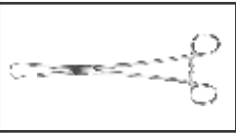

12S

GYNACOLOGICAL & OBSTETRICAL INSTRUMENTS

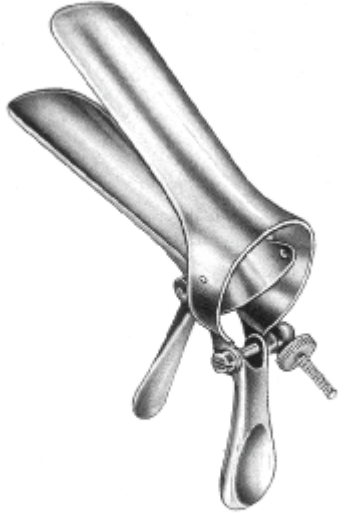

Cusco Vaginal Specula

ARTICLE #	SIZE
12S-020	75 x 32mm
12S-021	85 x 35mm
12S-022	100 x 35mm
12S-023	75 x 17mm

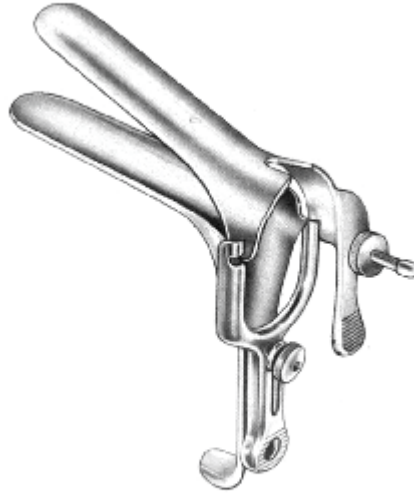

Pederson Vaginal Specula

ARTICLE #	SIZE
12S-024	75 x 13mm
12S-025	100 x 22mm
12S-026	120 x 25mm

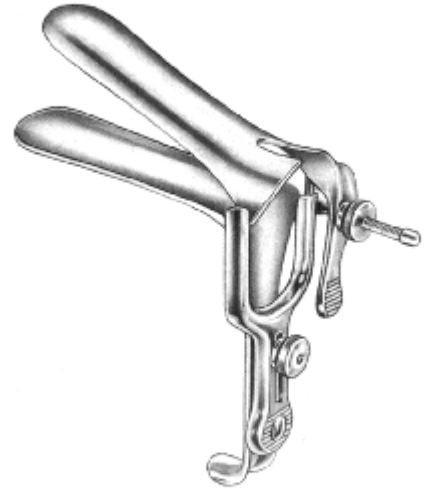

Grave Vaginal Specula

ARTICLE #	SIZE
12S-027	75 x 20mm
12S-028	95 x 35mm
12S-029	115 x 35mm

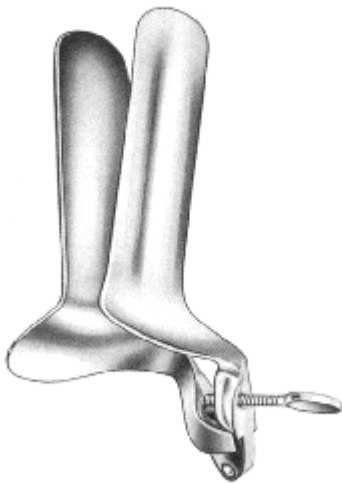

Collin Vaginal Specula

ARTICLE #	SIZE
12S-030	85 x 30mm
12S-031	100 x 35mm
12S-032	110 x 40mm



Sims Vaginal Specula

ARTICLE #	SIZE
12S-033	60 x 25/30mm
12S-034	70 x 30/35mm
12S-035	80 x 35/40mm

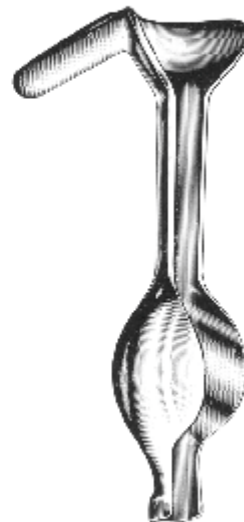

Auvard Weighted Vaginal Specula

ARTICLE #	SIZE
12S-036	2 lbs
12S-037	2,5 lbs
12S-038	3 lbs

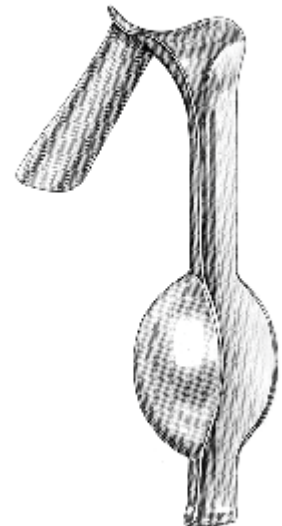

12S-039

Weighted Vaginal Specula 2,5 lbs



12S

GYNACOLOGICAL & OBSTETRICAL INSTRUMENTS



Kristeller Vaginal Specula

12S-040	#000	70 x 27mm
12S-041	#00	80 x 30mm
12S-042	#0	90 x 36mm
12S-043	#1	110 x 27mm
12S-044	#2	110 x 30mm
12S-045	#3	110 x 36mm



Kristeller Vaginal Specula

12S-046	#000	75 x 23mm
12S-047	#00	85 x 26mm
12S-048	#0	100 x 32mm
12S-049	#1	115 x 23mm
12S-050	#2	115 x 26mm
12S-051	#3	115 x 32mm



Kristeller Vaginal Specula Set

12S-052	#000
12S-053	#00
12S-054	#0
12S-055	#1
12S-056	#2
12S-057	#3



Doyen Vaginal Specula

12S-058	55 x 35mm
12S-059	85 x 35mm
12S-060	115 x 35mm



Doyen Vaginal Specula

12S-061	55 x 45mm
12S-062	85 x 45mm
12S-063	115 x 45mm



Doyen Vaginal Specula

12S-064	55 x 60mm
12S-065	85 x 60mm
12S-066	115 x 60mm

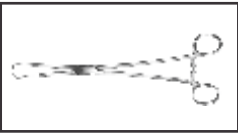

12S

GYNACOLOGICAL & OBSTETRICAL INSTRUMENTS



12S-067
Sims Uterine
Sound 13" (32 cm)



12S-068
Martin Uterine
Sound 13" (32 cm)



Sims Uterine Curettes
12½" (31 cm)

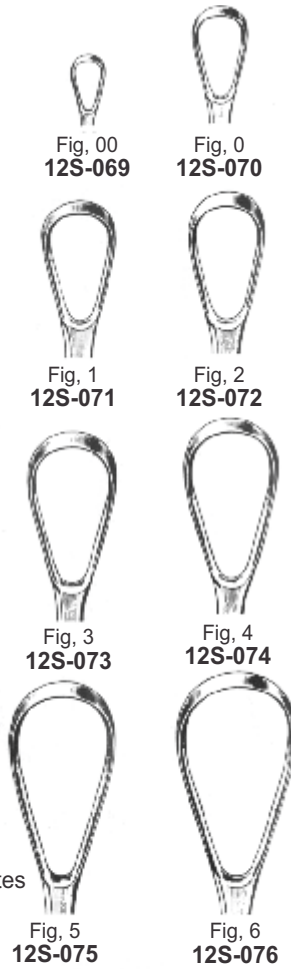

Fig. 00
12S-069

Fig. 0
12S-070

Fig. 1
12S-071

Fig. 2
12S-072

Fig. 3
12S-073

Fig. 4
12S-074

Fig. 5
12S-075

Fig. 6
12S-076



Thomas Uterine Curettes
12½" (31 cm)

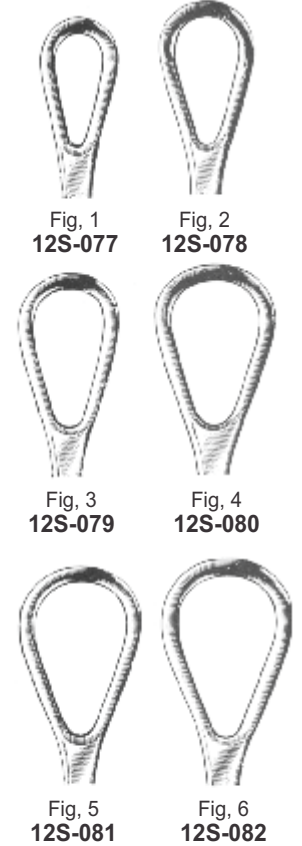

Fig. 1
12S-077

Fig. 2
12S-078

Fig. 3
12S-079

Fig. 4
12S-080

Fig. 5
12S-081

Fig. 6
12S-082

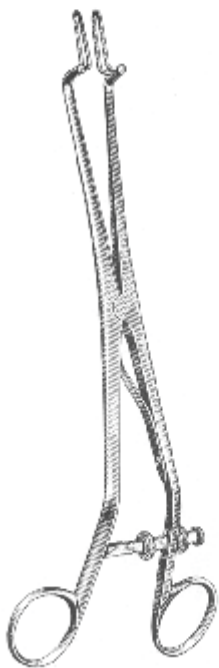

12S-083
Kogan Endocervical
Speculum 9½" (24 cm)

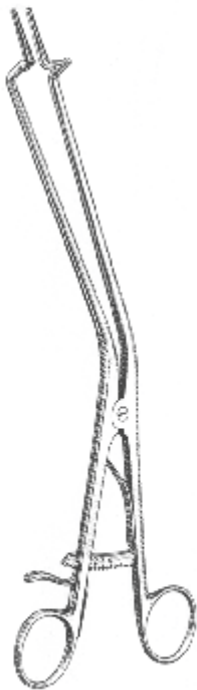

12S-084
Kogan Endocervical
Speculum 11" (28 cm)

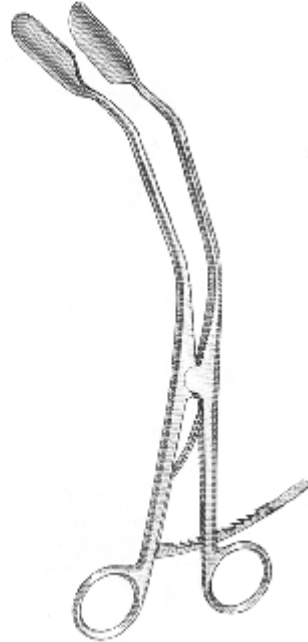

12S-085
Leep Lateral Vaginal
Retractor 8 ¼" (21 cm)

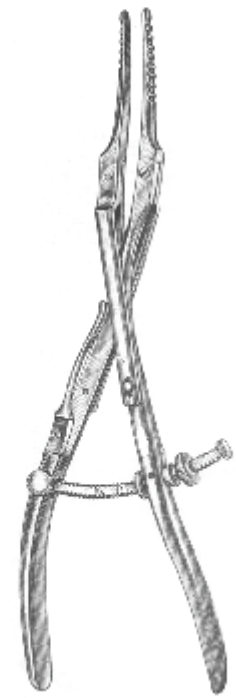

12S-086
Goodell Uterine
Dilator 10½"
(26,5 cm)

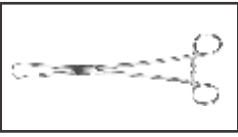

12S

GYNACOLOGICAL & OBSTETRICAL INSTRUMENTS



12S-087
Gaylor Uterine
Biopsy Forceps 8½"
(21,5 cm)



Thomas-Gaylor Uterine Biopsy Forceps

ARTICLE #	SIZE
12S-088	8½" (21,5 cm)
12S-089	9½" (24 cm)

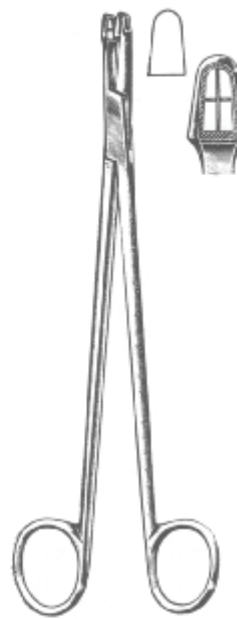

12S-090
Schubert Uterine
Biopsy Forceps 8½"
(21,5 cm)



12S-091
Schubert Uterine
Biopsy Forceps 8½"
(21,5 cm)

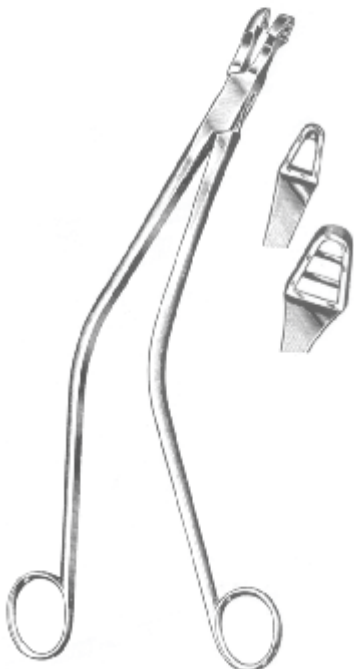

12S-092
Schubert Uterine Biopsy
Forceps 11" (28 cm)



12S-093
Schubert Uterine Biopsy
Forceps 11" (28 cm)



12S-094
Gellborn Uterine Biopsy Forceps
9½" (24 cm)

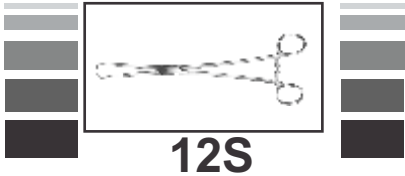

GYNACOLOGICAL & OBSTETRICAL INSTRUMENTS

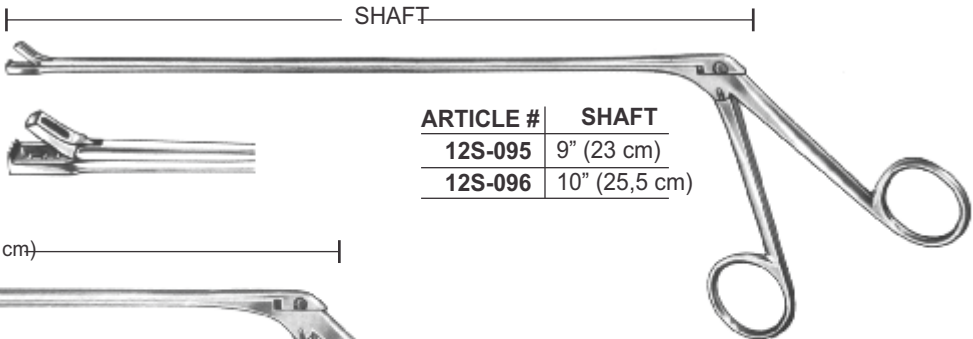

Kevorkian Biopsy Forceps

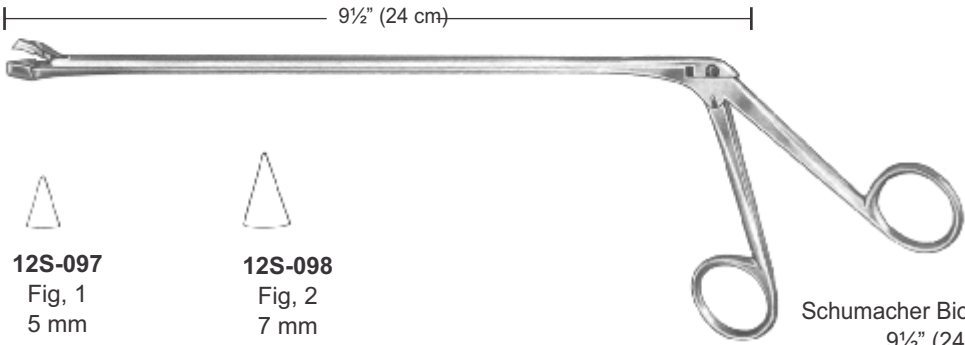

Schumacher Biopsy Forceps
9½" (24 cm)

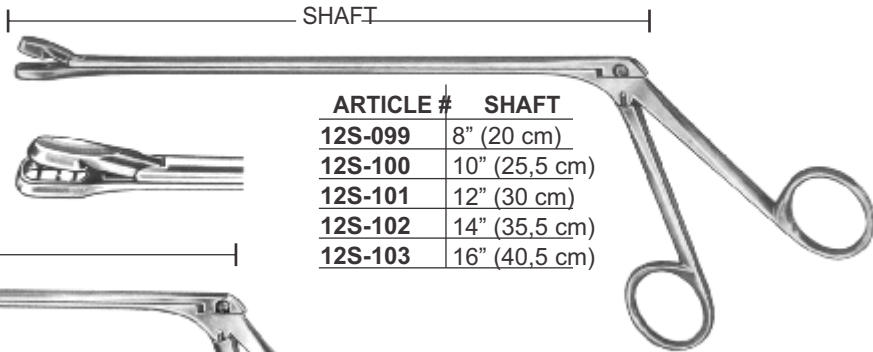

Doyen Biopsy Forceps

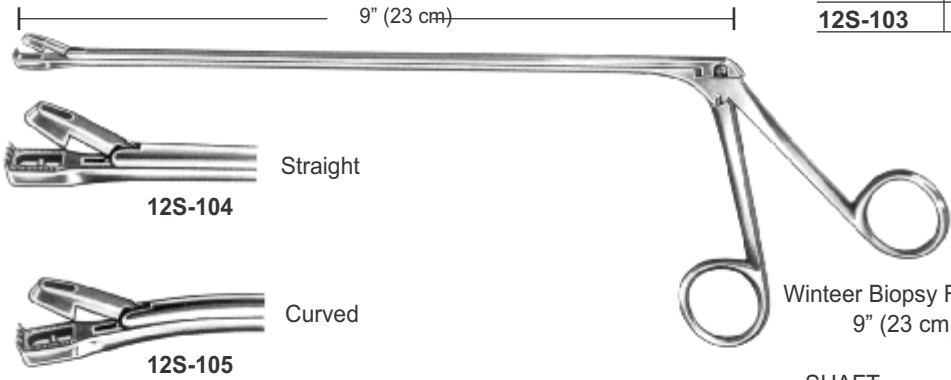

Winteer Biopsy Forceps
9" (23 cm)

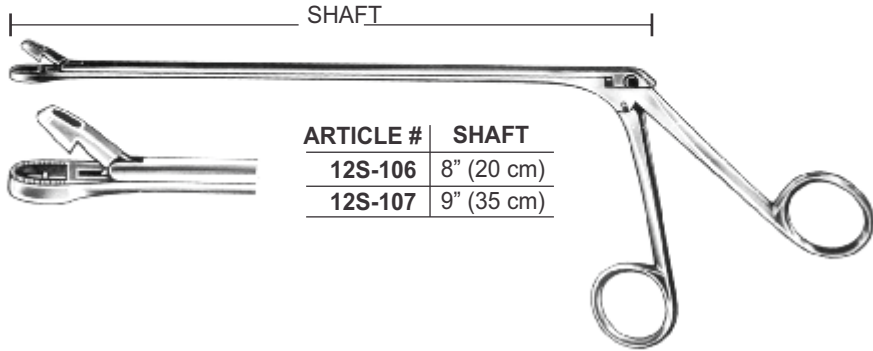

Eppendorf Biopsy Forceps

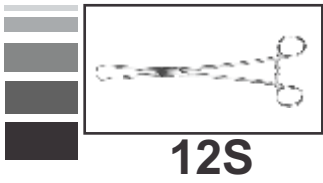

GYNACOLOGICAL & OBSTETRICAL INSTRUMENTS

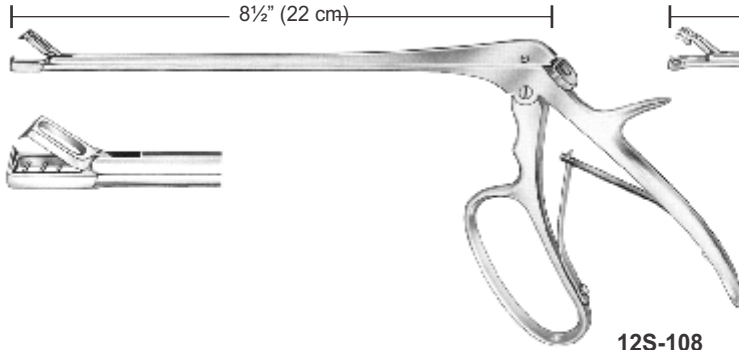

12S-108
Tischler-Kevrokian Biopsy Forceps

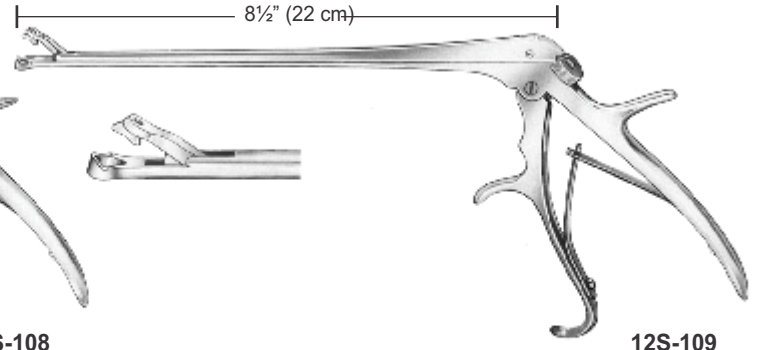

12S-109
Burke Biopsy Forceps

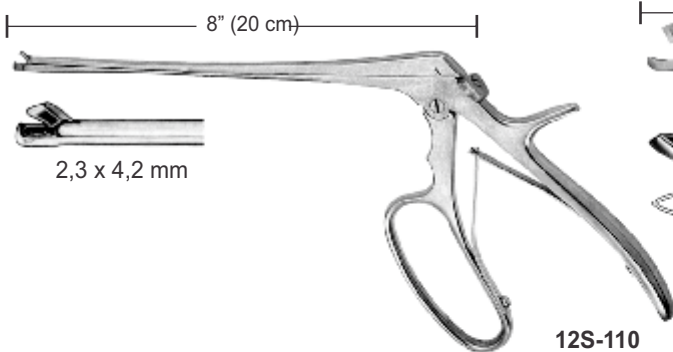

12S-110
Baby-Tischler Biopsy Forceps

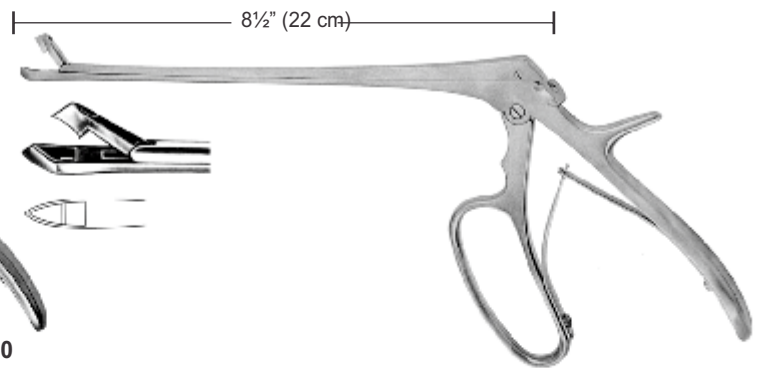

12S-111
Tischler Biopsy Forceps

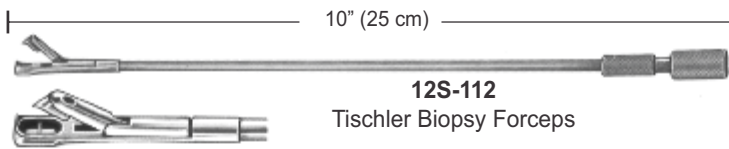

12S-112
Tischler Biopsy Forceps

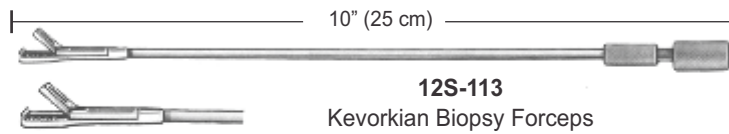

12S-113
Kevorkian Biopsy Forceps

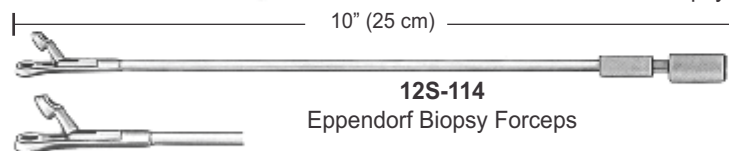

12S-114
Eppendorf Biopsy Forceps

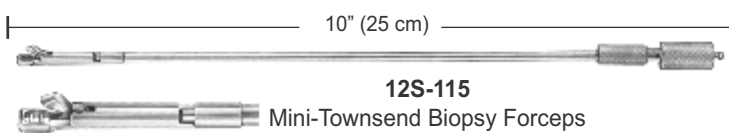

12S-115
Mini-Townsend Biopsy Forceps



12S-116
Handle

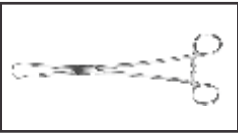

12S

GYNACOLOGICAL & OBSTETRICAL INSTRUMENTS



NEWMAX CORPORATION

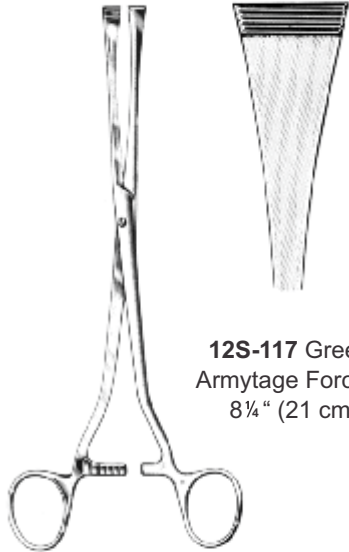

12S-117 Green-Armytage Forceps
8 1/4" (21 cm)



12S-118 Sellhein Forceps
11" (28 cm)

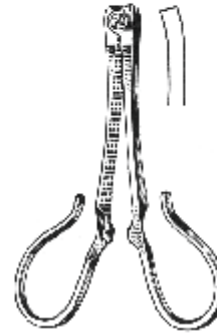

12S-119 Kane Clamps
3 1/2" (8,5cm)

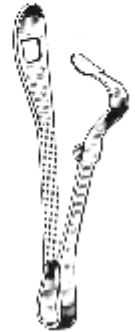

12S-120 Collin Clamps
3 1/2" (9 cm)

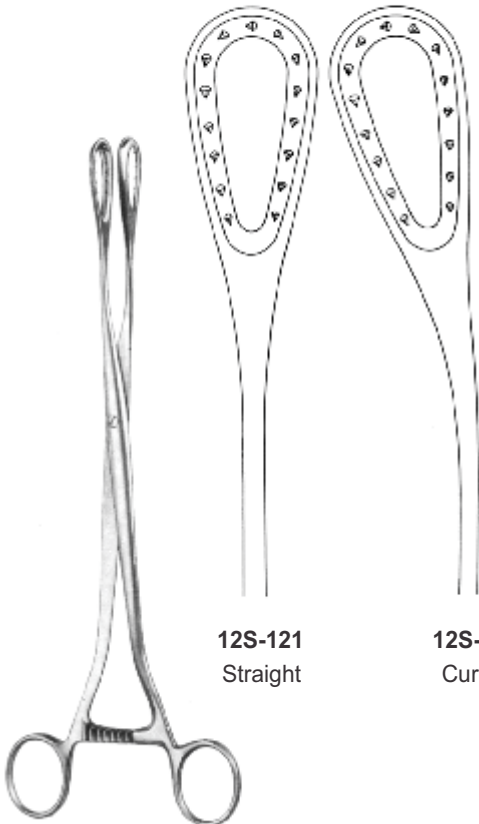

12S-121 Straight

12S-122 Curved

Saenger Forceps
10 1/2" (27 cm)



Winter Forceps
11" (28 cm)

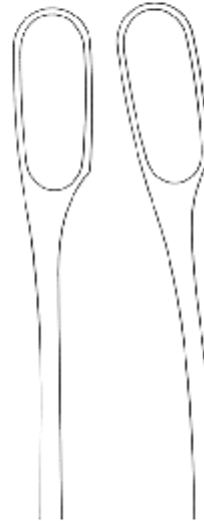

12S-123 Straight



12S-124 Curved



12S-125 Straight



12S-126 Curved



12S

GYNACOLOGICAL & OBSTETRICAL INSTRUMENTS



12S-127
Martin
Pelvineter 13½"
(34 cm)



Cuzzi Spoon
12" (30 cm)



14½mm

12S-128



18mm

12S-129

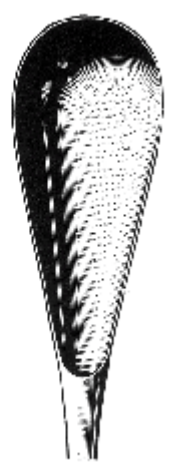

20mm

12S-130



Naegele Obstetrical Forceps
12S-131 | 14" (36 cm)
12S-132 | 16" (40 cm)



12S-133
Simpson Obstetrical
Forceps 12" (30 cm)

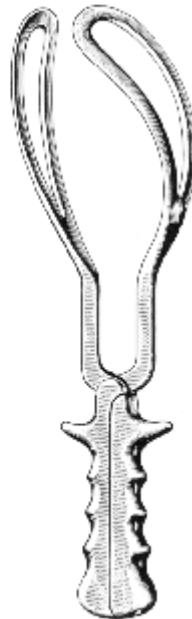

12S-134
Simpson-Braun
Obstetrical Forceps 14"
(36 cm)

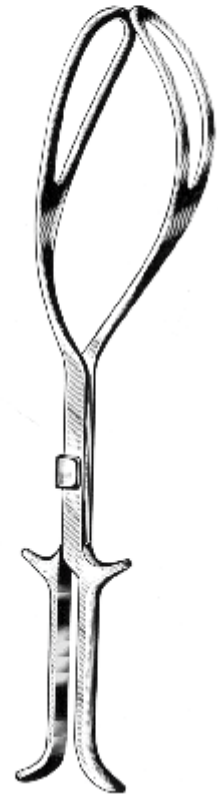

12S-135
Kielland Obstetrical
Forceps 16" (41 cm)



13S

EYE INSTRUMENTS

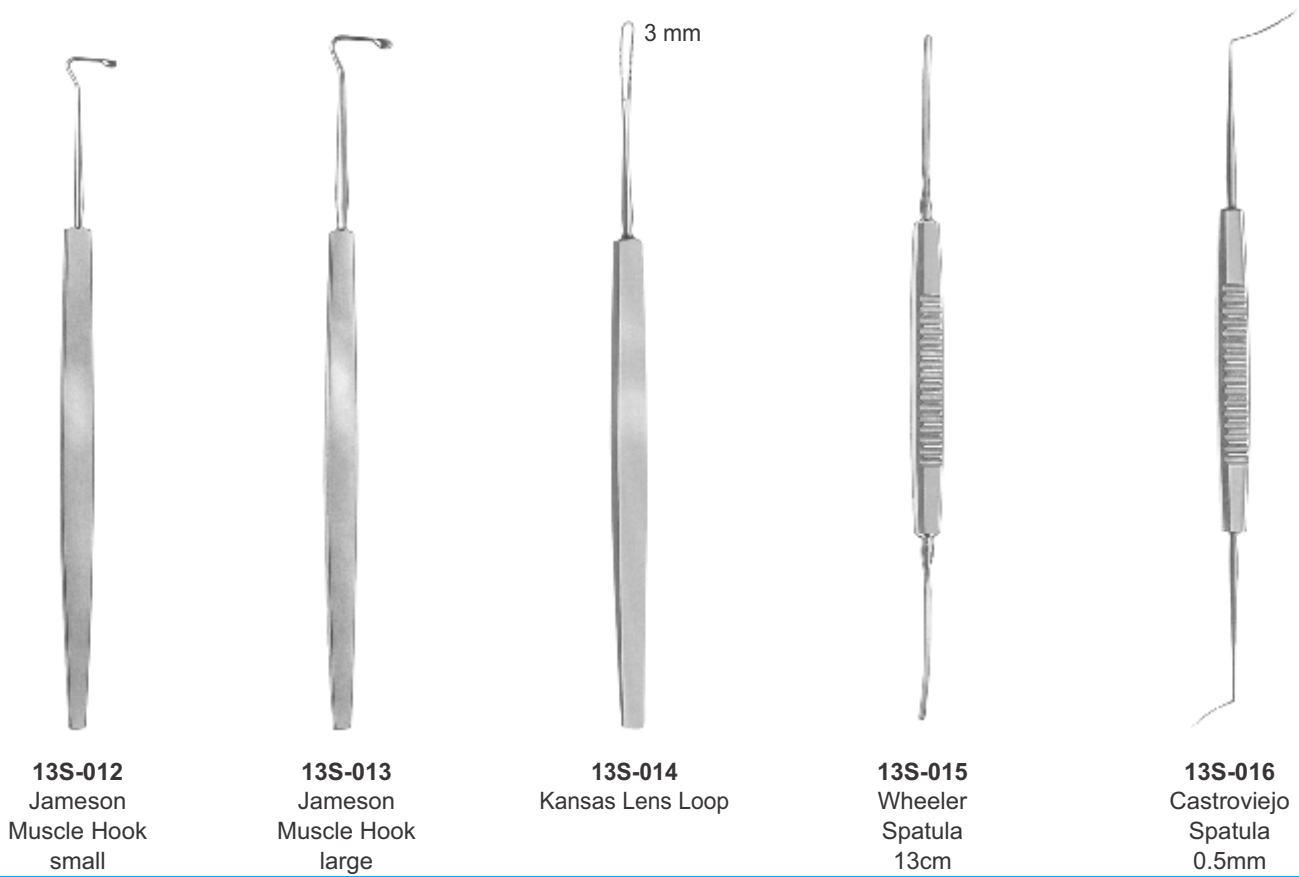
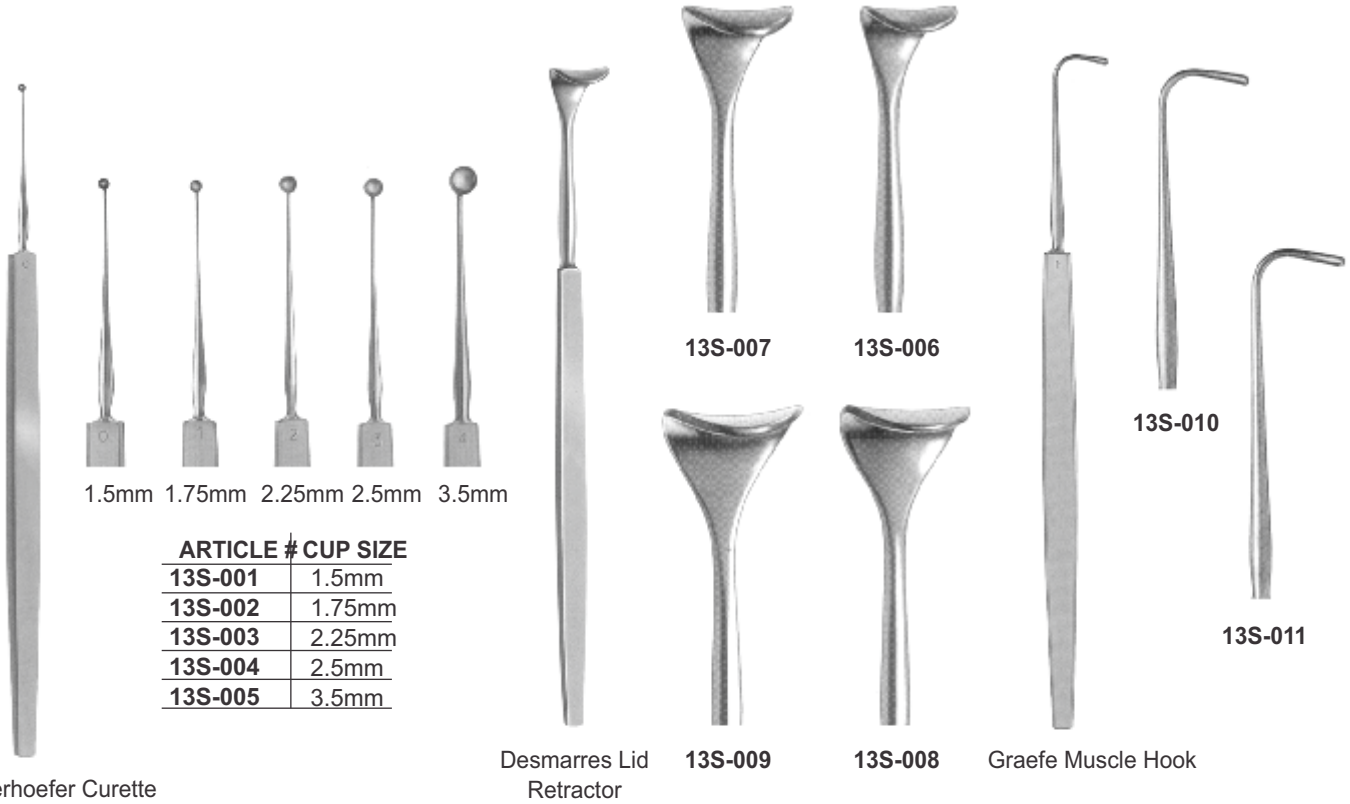



13S

EYE INSTRUMENTS



NEWMAX CORPORATION



13S-017
Barraquer Eye
Speculum small



13S-018
Barraquer Eye
Speculum large

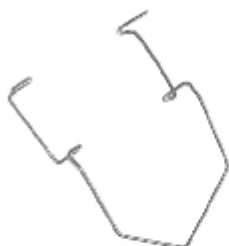

13S-019
Kratz-Barraquer Eye
Speculum large

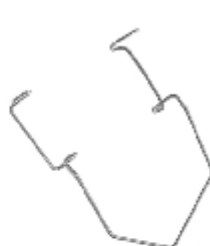

13S-020
Kratz-Barraquer Eye
Speculum small



13S-021
Barraquer small



13S-022
Barraquer large



13S-023
Lieberman
Eye Speculum,
K-wire



13S-024
Lieberman
Eye Speculum,
V-wire



13S-025
Lieberman
Eye Speculum,
Pediatric Thin
Solid Blade



13S-026
Lieberman
Eye Speculum,
Pediatric Thin
Solid Blade



13S-026
Castroviejo Caliper

13S-027
Curved



13S-028
Angled



13S-029
Straight



13S-030
Stevenson
Lacrimal
Sac Retractor
Solid Blade



13S-031
Stevenson Lacrimal
Sac Retractor 3x3
Blunt Prong



13S-032
Jaeger Lid
Plate
Stainless
Steel

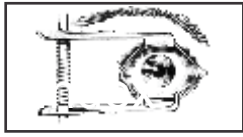

13S

EYE INSTRUMENTS



13S-033
Graefe Iris
Forceps 2 3/4" (7
cm)

13S-034
Graefe Iris Forceps
2 3/4" (7 cm)

13S-035
Graefe 1:2 Iris
Forceps 2 3/4" (7 cm)

13S-036
Graefe 1:2 Iris Forceps
2 3/4" (7 cm)



13S-037



13S-038



13S-039



13S-040



13S-041



13S-042



10x
13S-043



10x
13S-044



10x
13S-045

Graefe Iris Forceps
4 1/2" (11 cm)

(Colibri) Iris Forceps
2 3/4" (7 cm)

Troutman
(Corneal) Iris
Forceps 3"
(7.5cm)

Troutman
(Colibri) Iris
Forceps 2 "
(7 cm)

EYE INSTRUMENTS

13S



13S-046 Bishop-Hartman Forceps
3½" (8.5cm)



13S-047 Bishop-Hartman Forceps
3½" (8.5cm)



13S-048 Bishop-Hartman Forceps
3½" (8.5cm)



13S-049 Bishop-Hartman Forceps
3½" (8.5cm)



13S-050 Kirby Forceps
3½" (9 cm)



13S-051 Erhardt Chalazion Forceps 3½" (9 cm)



13S-052 Ayer Chalazion Forceps 3½" (9 cm)



13S-053 Ayer Chalazion Forceps 3½" (9 cm)



13S-054 - 13S-056 Desmarres Chalazion Forceps 3½" (9 cm)



13S-054

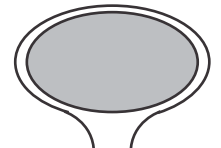

13S-055

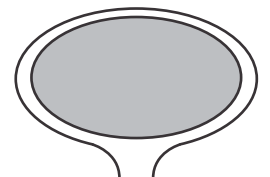

13S-056

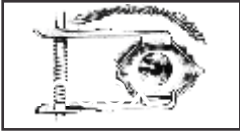

13S

EYE INSTRUMENTS



13S-057
Graefe Fixation
Forceps 4" (10
cm)



Castroviejo 1:2
Fixation Forceps
4" (10 cm)



ARTICLE #	1x2 T Width
13S-058	0.12mm
13S-059	0.30mm
13S-060	0.50mm
13S-061	1.00mm
13S-062	1.50mm



Castroviejo 1:2
Fixation Forceps
3½" (9 cm)

Straight



13S-063

Curved



13S-064



13S-065
Elsching 1:2 Fixation
Forceps 4½" (11 cm)



13S-066
Paufigue 1:2 Suture
Forceps 4" (10 cm)



13S-067
Elschnig 2:3
Fixation Forceps
4½" (11 cm)



13S-068
Elschnig 3:4
Fixation Forceps
4½" (11 cm)



Lester Fixation Forceps
3½" (9 cm)

1:2
13S-069

2:3
13S-070



13S-071
Moorfield Fixation
Forceps 4" (10 cm)





13S

EYE INSTRUMENTS



NEWMAX CORPORATION

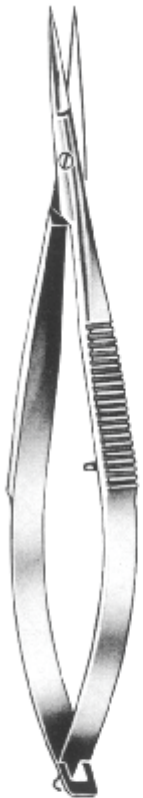

13S-072

13S-073

13S-074

13S-072 - 13S-074
Noyes Iris Scissors
4 3/4" (12 cm)

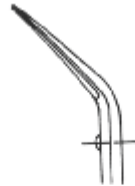

13S-075
Noyes Iris Scissors
4 3/4" (12 cm)



13S-076



13S-077



13S-078

Wecker Scissors
4 1/2" (11 cm)



13S-079 Barraquer Scissors
2 1/4" (5.5cm)

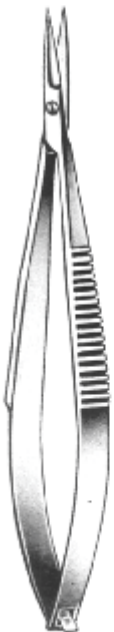

13S-080

13S-081



13S-081



13S-082



13S-083

Castroviejo Scissors
3 1/2" (9 cm)

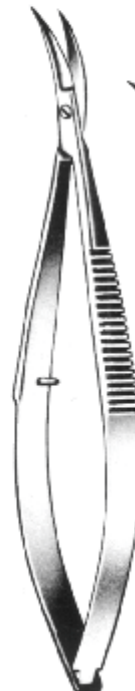

13S-084
Castroviejo Scissors
4" (10 cm)

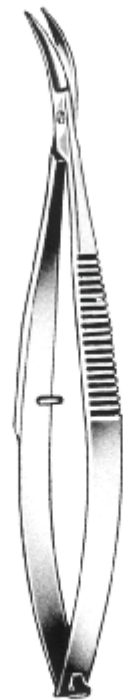

13S-085
Castroviejo Scissors
4" (10 cm)

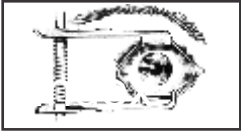

13S

EYE INSTRUMENTS



NEWMAX CORPORATION



13S-086
Westcott Tenotomy
Scissors 4½" (11 cm)

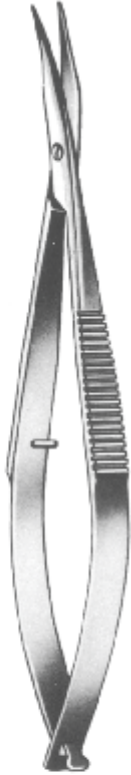

13S-087
Westcott Tenotomy
Scissors 4½" (11 cm)

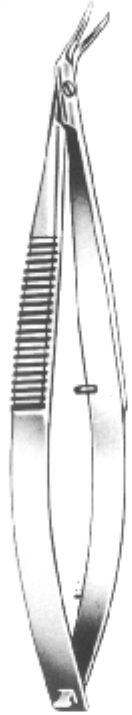

13S-088
Castroviejo Corneal
Scissors 4" (10 cm)



13S-089
Castroviejo Corneal
Scissors 4" (10 cm)

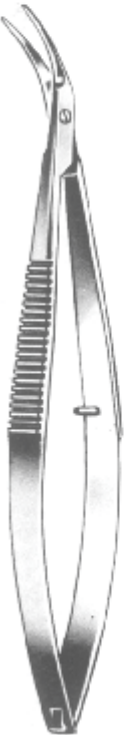
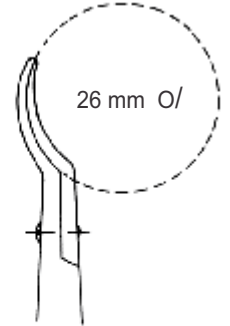

13S-090
Castroviejo Corneal
Scissors 4½" (11 cm)

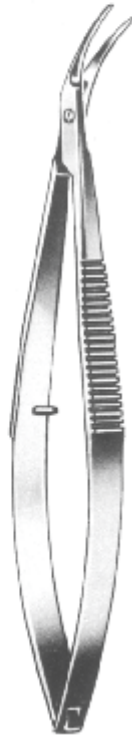

13S-091
Castroviejo Corneal
Scissors 4½" (11 cm)

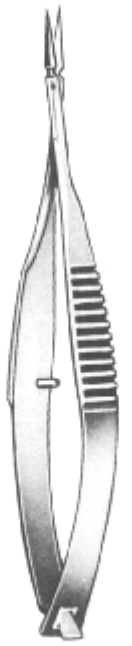

13S-092
Vannas Scissors
Straight, 3½" (8.5cm)

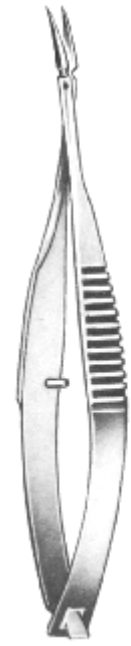

13S-093
Vannas Scissors
Curved, 3½" (8.5cm)

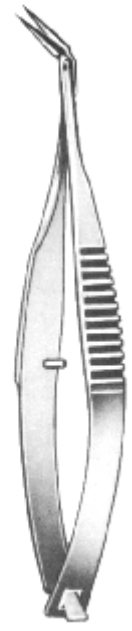

13S-094
Vannas Scissors
Angled, 3½" (8.5cm)

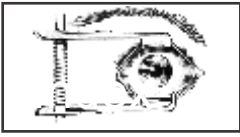

13S

EYE INSTRUMENTS

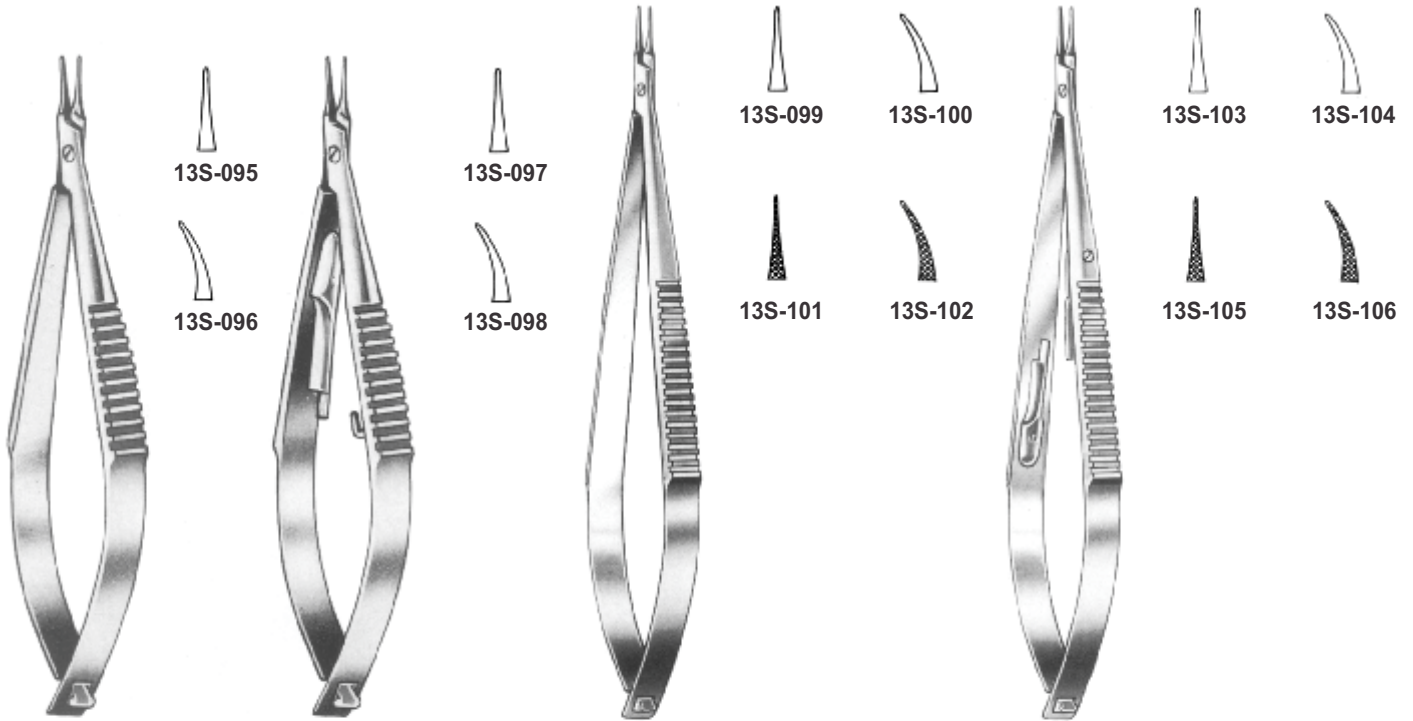

Castroviejo Needle Holders
3 1/2" (9 cm)

Castroviejo Needle Holders
3 1/2" (9 cm)

Castroviejo Needle Holders
5 1/2" (14 cm)

Castroviejo Needle Holders
5 1/2" (14 cm)

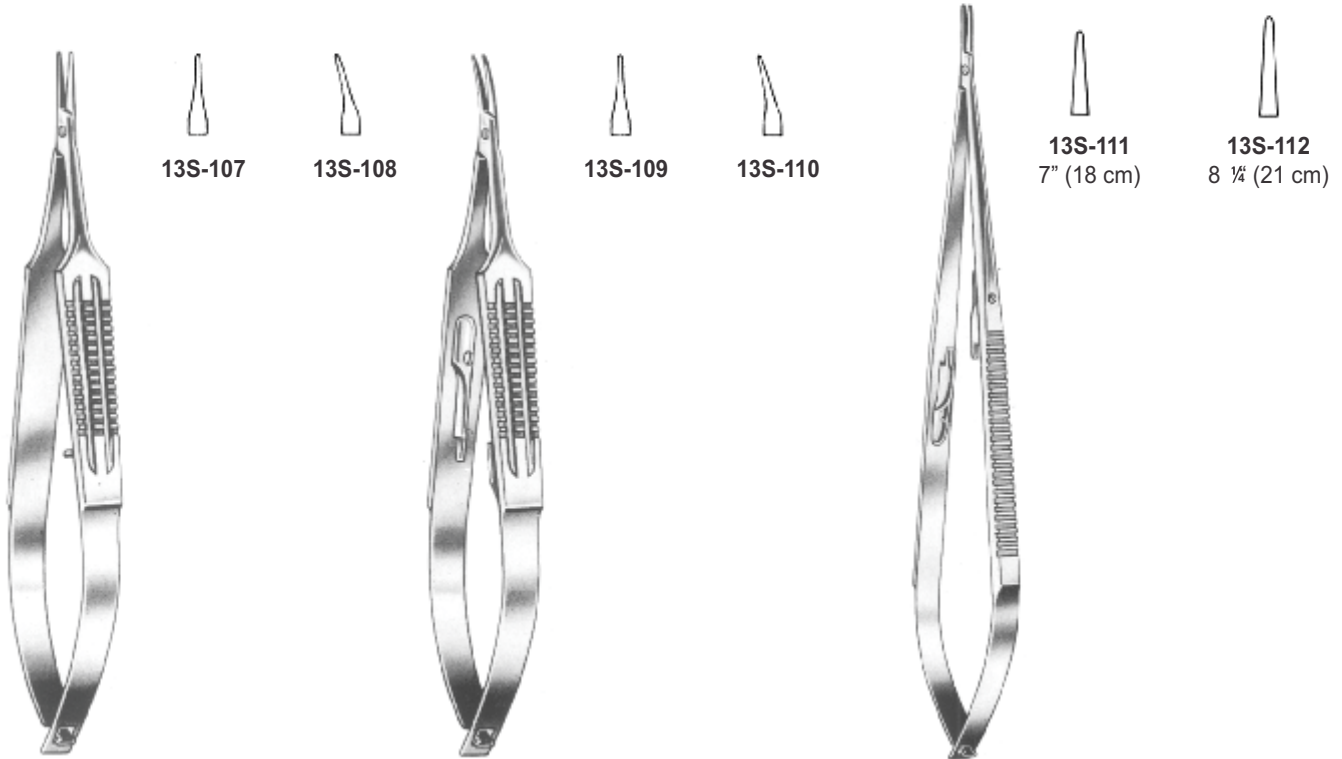

Castroviejo Needle Holders
5 1/2" (14 cm)

Castroviejo Needle Holders
5 1/2" (14 cm)

Jacobson Needle Holders

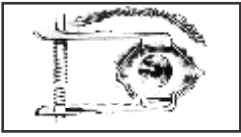

13S

EYE INSTRUMENTS

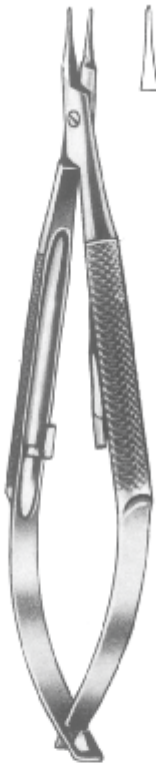

13S-113
Barraquer-Troutman
Needle
Holder
4" (10 cm)

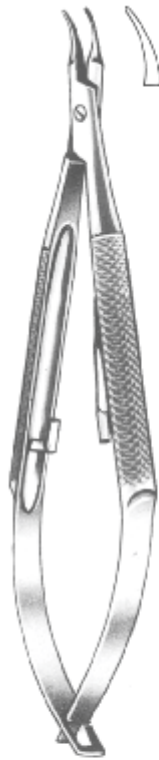

13S-114
Barraquer-Troutman
Needle
Holder
4" (10 cm)



13S-115
Barraquer-Troutman
Needle
Holder
4" (10 cm)



13S-116
Barraquer-Troutman
Needle
Holder
4" (10 cm)



13S-117
Barraquer
Needle Holder 4
" (11 cm)



13S-118
Barraquer
Needle Holder 5"
(13 cm)



13S-119
Barraquer
Needle Holder
5½" (14 cm)



13S-120
Barraquer
Needle Holder
5½" (14 cm)



13S-121
Barraquer
Needle Holder
5½" (14 cm)



13S

EYE INSTRUMENTS

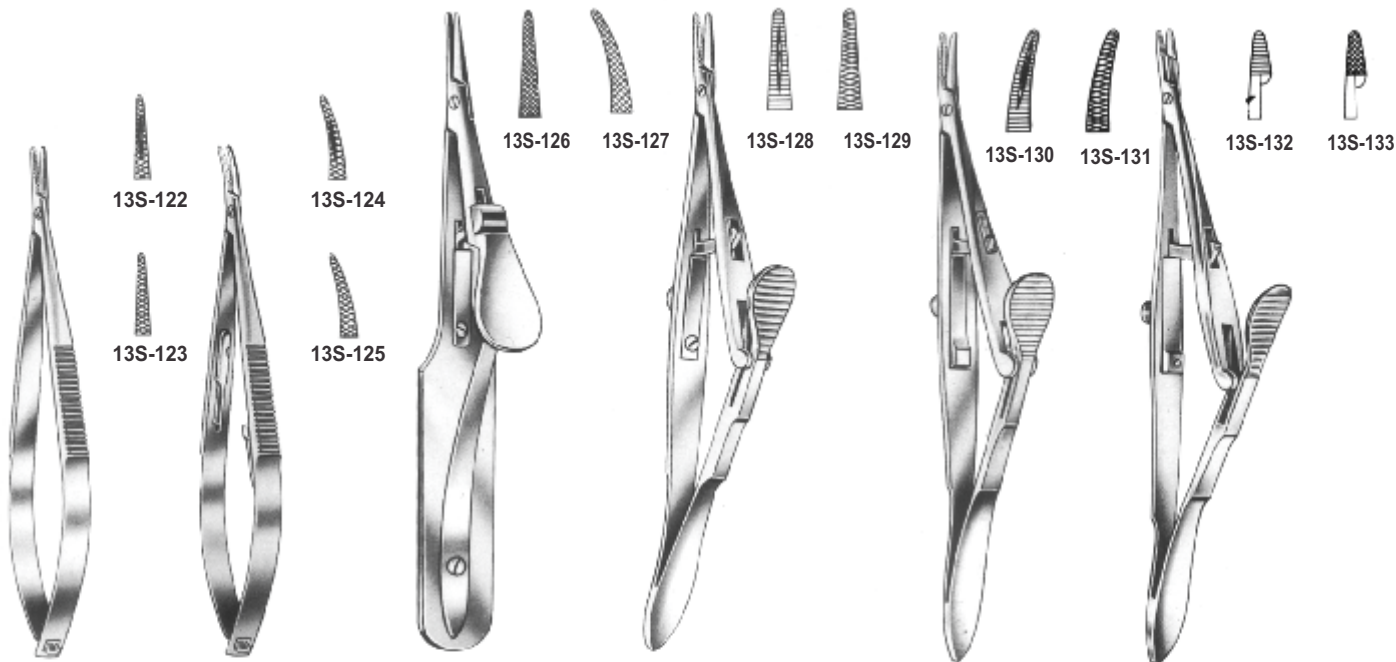

Paton Needle Holder 4½" (11 cm) Paton Needle Holder 4½" (11 cm) Arruga Needle Holder 5½" (14 cm) Kalt Needle Holder 5½" (14 cm) Kalt-Arruga Needle Holder 5½" (14 cm) Castroviejo-Kalt Needle Holder 5 ¼" (13.5cm)

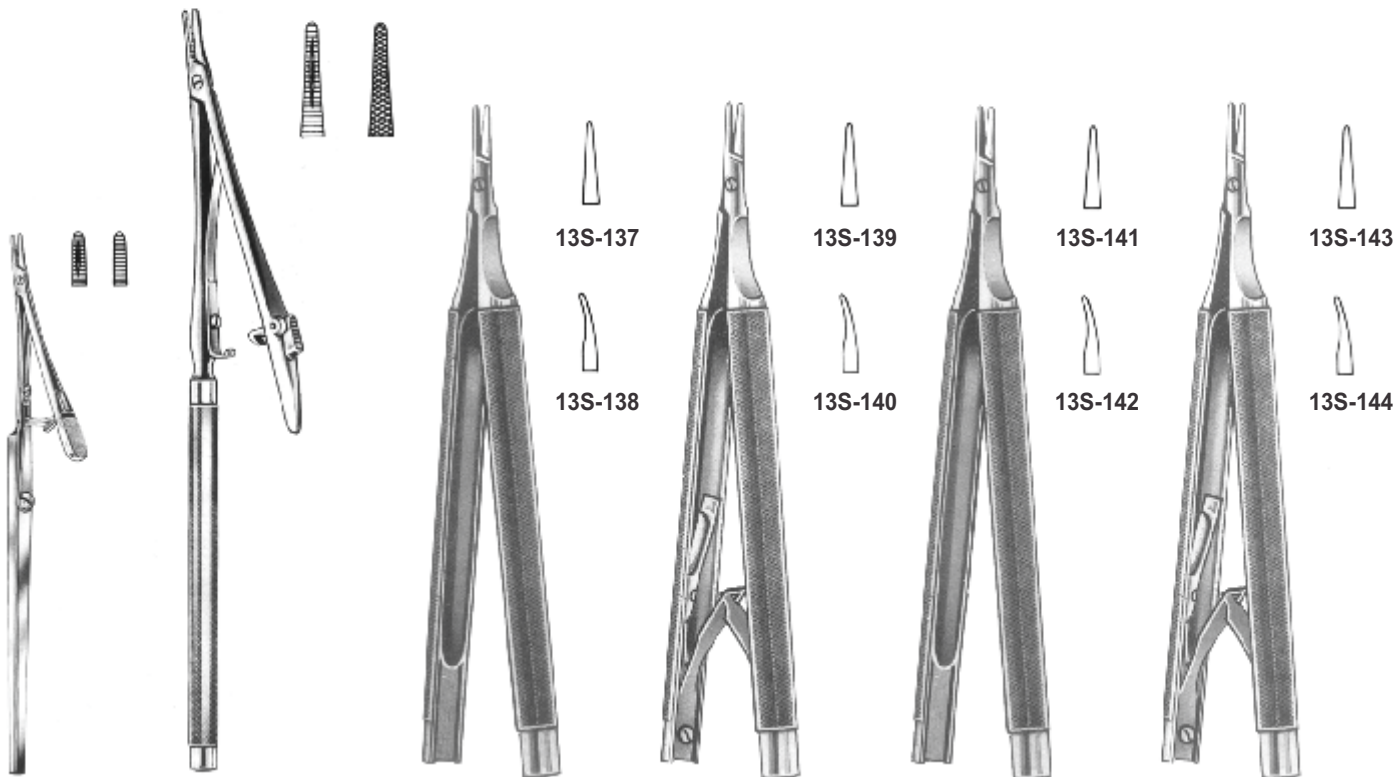

Stevens Needle Holder 5" (13 cm) 6" (15 cm) 13S-136 Potts-Smith Needle Holder 8 ¾" (22 cm) Castroviejo Blade Breaker 5 ¼" (13 cm) Castroviejo Blade Breaker 5 ¼" (13 cm) Castroviejo Blade Breaker 5 ¼" (13 cm) Castroviejo Blade Breaker 5 ¼" (13 cm)

ATRAUMATIC INSTRUMENTS

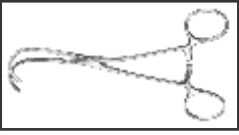

14S

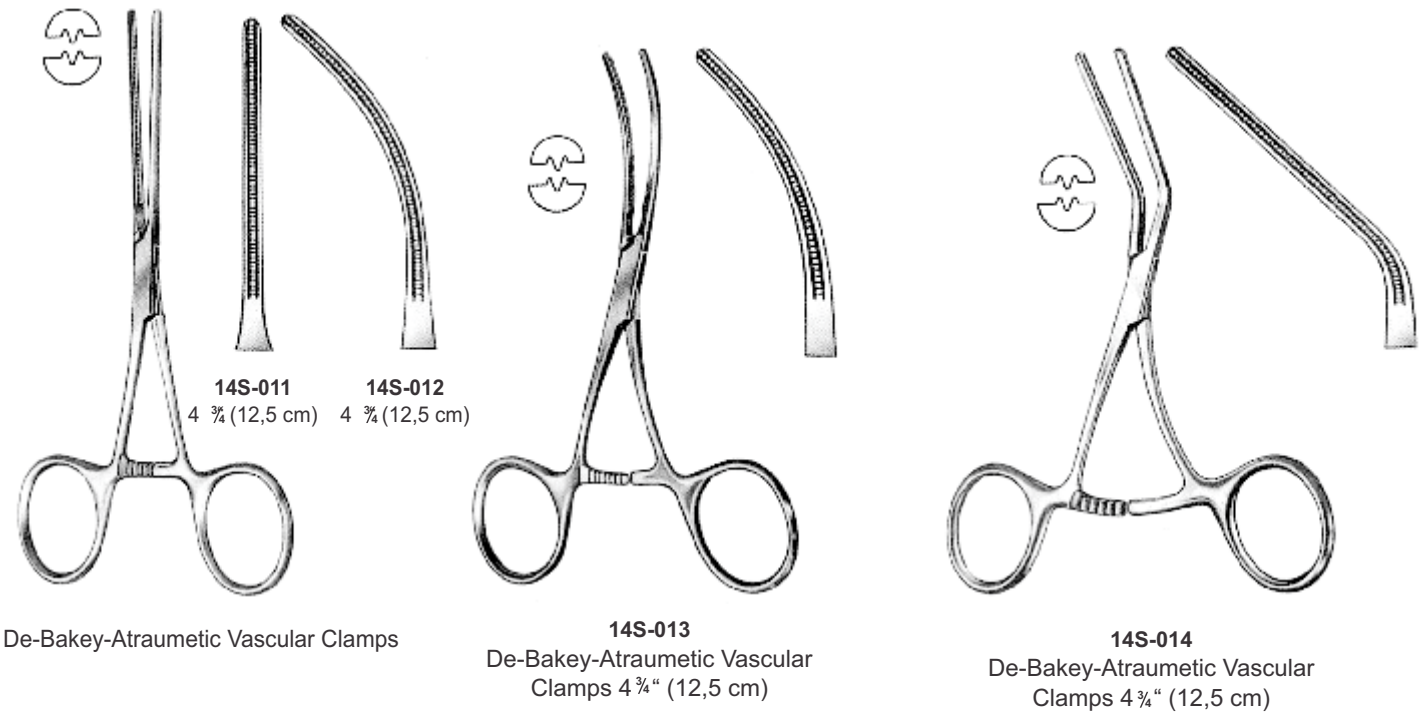
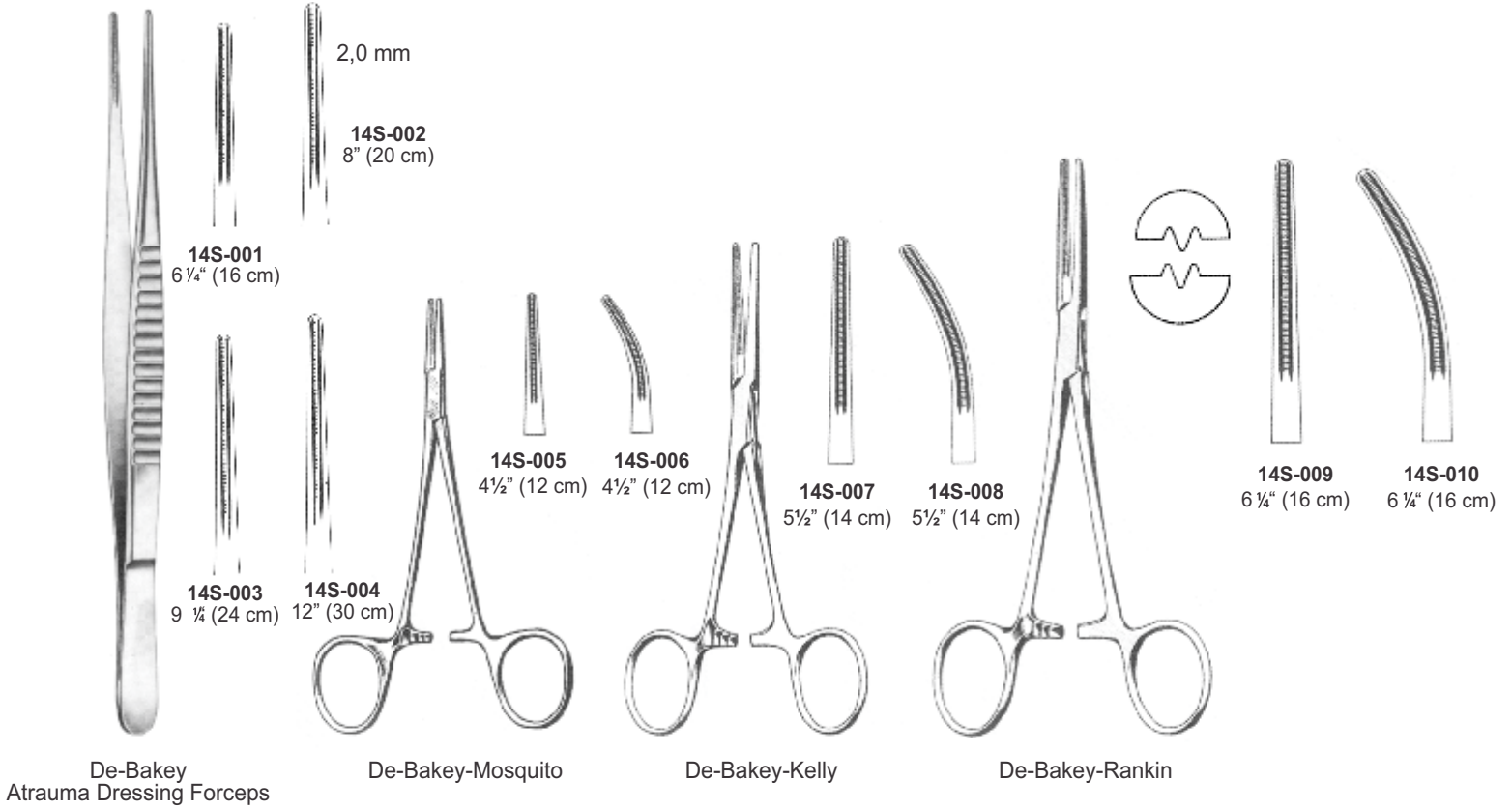

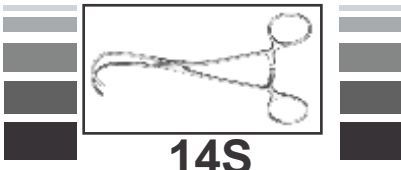

14S

ATRAUMATIC INSTRUMENTS

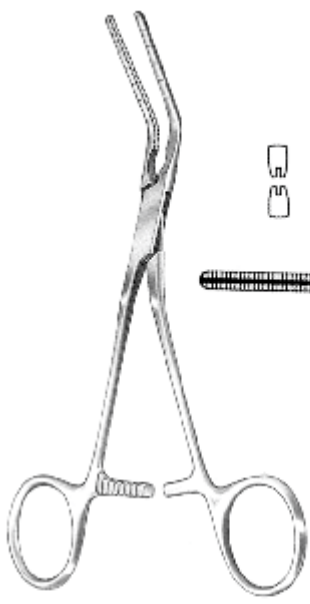

Cooley
Atraumatic Vascular Clamps

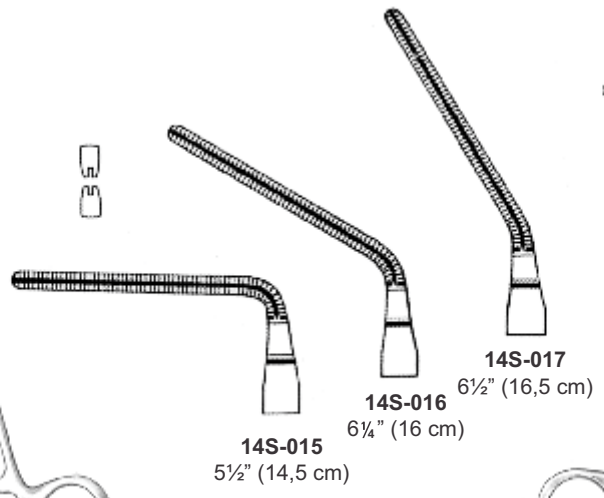

14S-015
5½" (14,5 cm)

14S-016
6¼" (16 cm)

14S-017
6½" (16,5 cm)

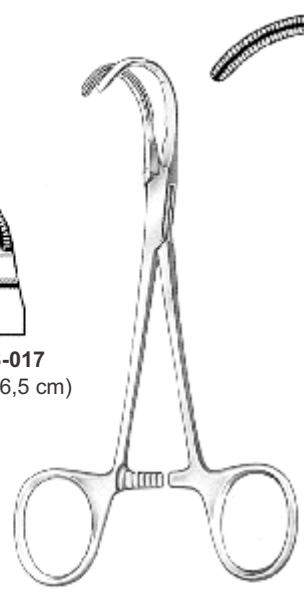

Cooley-Beck
Atraumatic Vascular Clamps

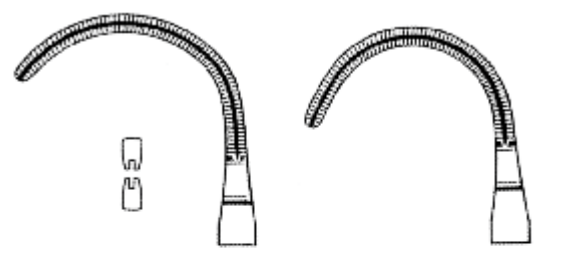

14S-018
6½" (16,5 cm)

14S-019
6" (15 cm)

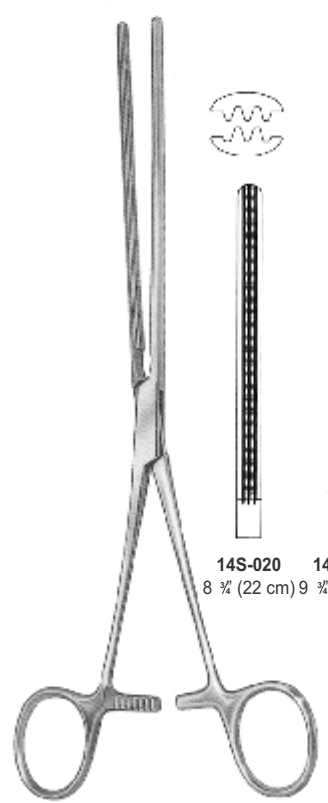

De-Bakey
Atraumatic Intestinal Clamps

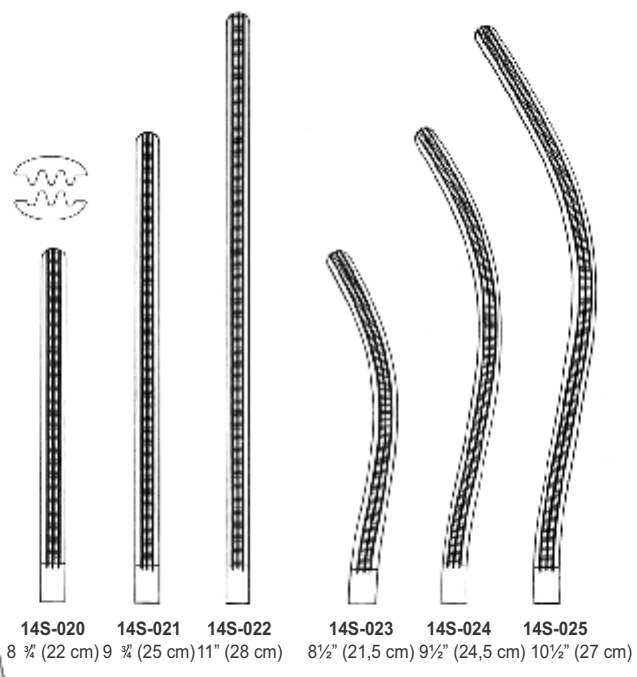

14S-020
8 ¾" (22 cm)

14S-021
9 ¾" (25 cm)

14S-022
11" (28 cm)

14S-023
8½" (21,5 cm)

14S-024
9½" (24,5 cm)

14S-025
10½" (27 cm)

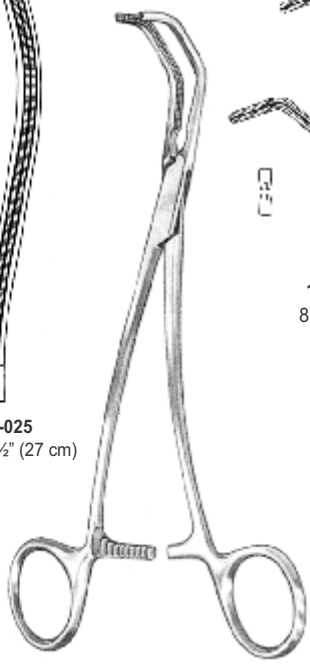

Cooley
Atraumatic Vascular Clamps

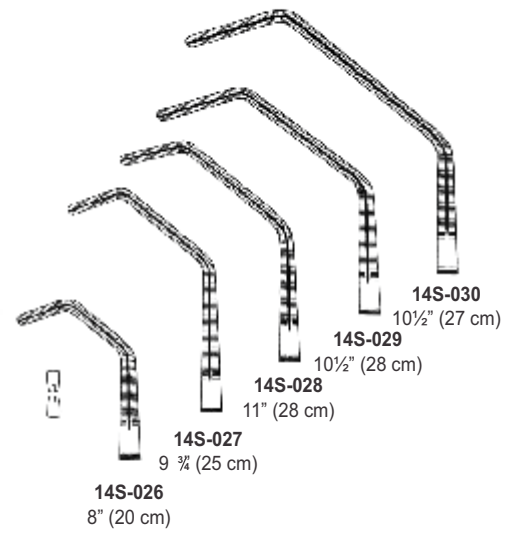

14S-026
8" (20 cm)

14S-027
9 ¾" (25 cm)

14S-028
11" (28 cm)

14S-029
10½" (28 cm)

14S-030
10½" (27 cm)



TUNGSTEN CARBIDE INSTRUMENTS (T.C)

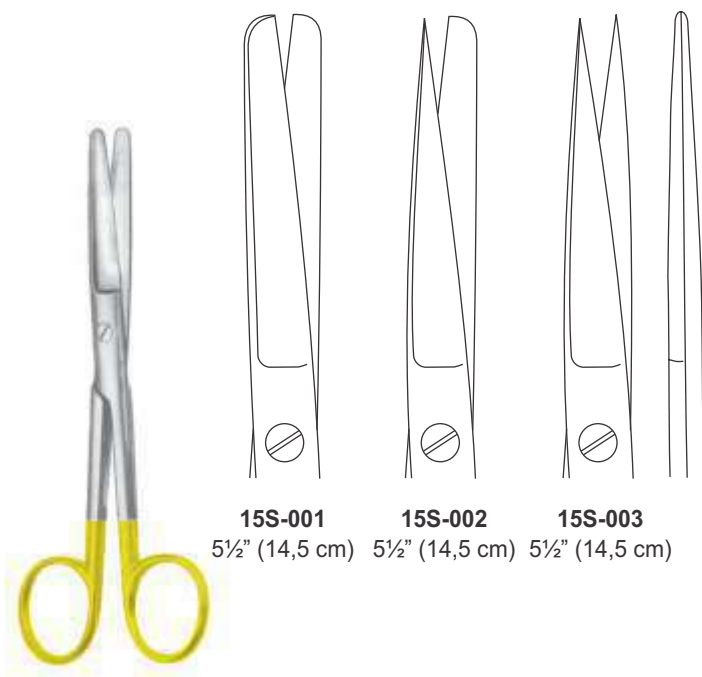

15S-001 5½" (14,5 cm)
15S-002 5½" (14,5 cm)
15S-003 5½" (14,5 cm)



15S-004 5½" (14,5 cm)
15S-005 5½" (14,5 cm)
15S-006 5½" (14,5 cm)

Dressing Scissors, Straight T.C

Dressing Scissors, Curved T.C

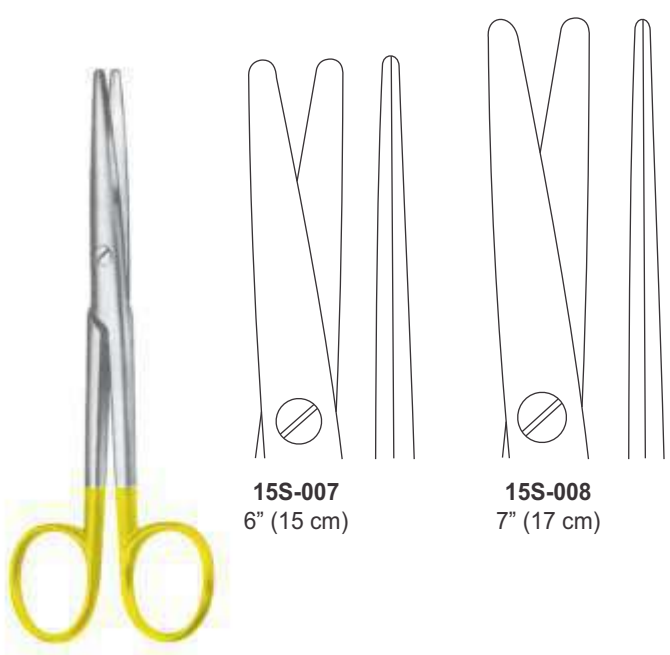

15S-007 6" (15 cm)
15S-008 7" (17 cm)

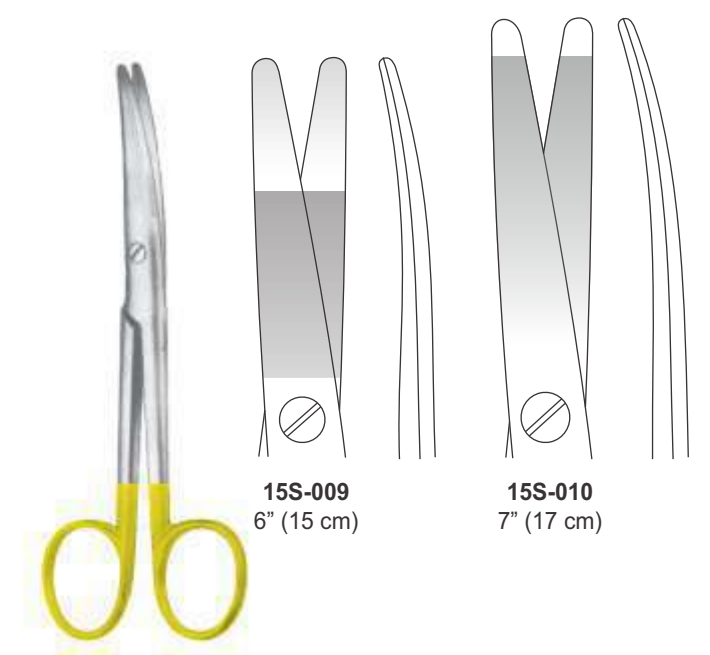

15S-009 6" (15 cm)
15S-010 7" (17 cm)

Mayo Stille Scissors, Straight T.C

Mayo Stille Scissors, Curved T.C



15S

TUNGSTEN CARBIDE INSTRUMENTS (T.C)



Mayo Scissors, Straight T.C

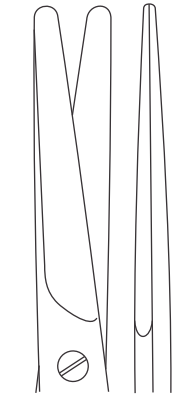

15S-011
5½" (14 cm)

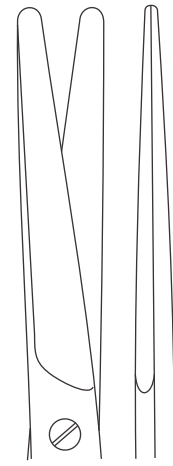

15S-012
7" (17 cm)

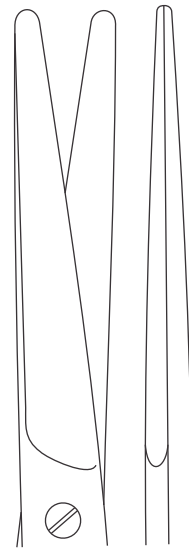

15S-013
9" (23 cm)



Mayo Scissors, Curved T.C

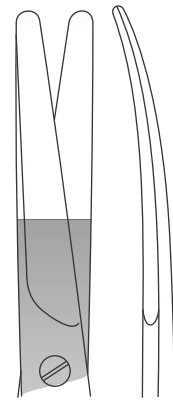

15S-014
5½" (14 cm)

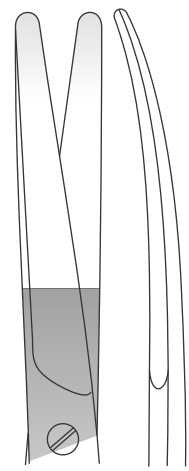

15S-015
7" (17 cm)

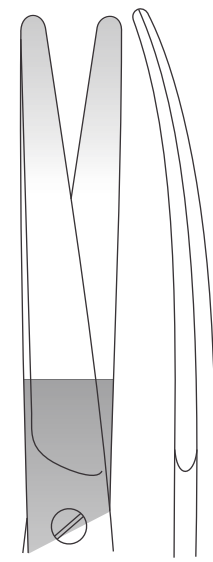

15S-016
9" (23 cm)



TUNGSTEN CARBIDE INSTRUMENTS (T.C)

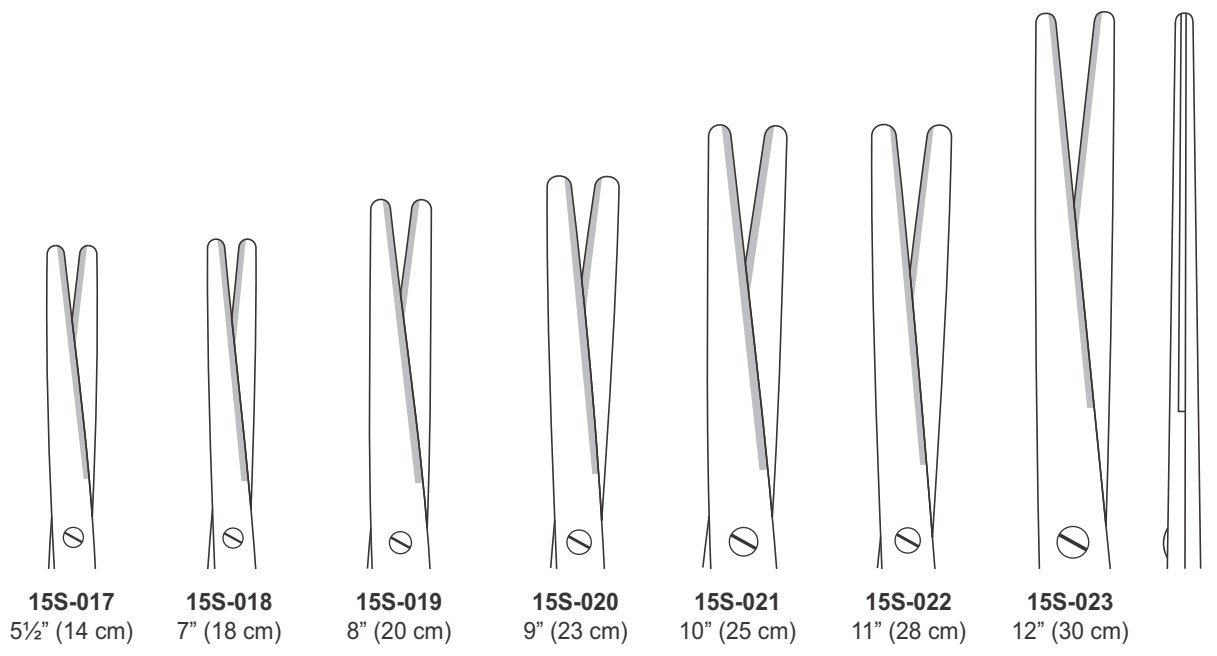

Metzenbaum Scissors
Straight T.C

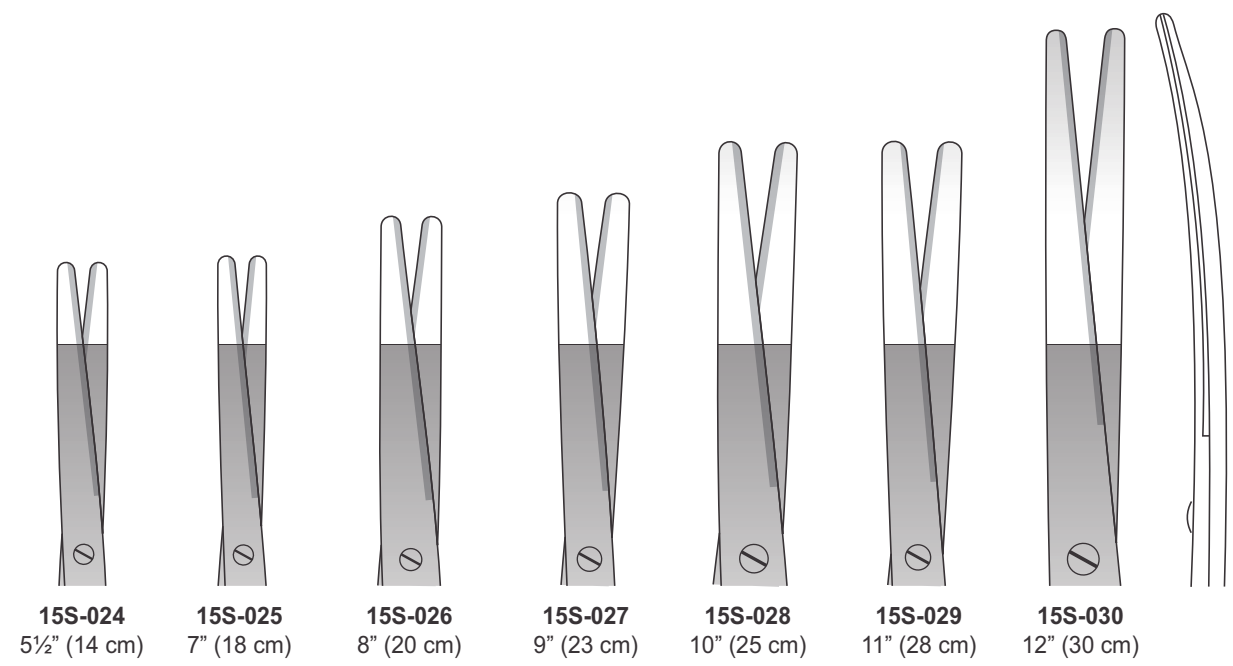

Metzenbaum Scissors
Curved T.C



15S

TUNGSTEN CARBIDE INSTRUMENTS (T.C)



15S-041 **15S-042**
4 3/4" (12 cm) 4 3/4" (12 cm)

Adson Forceps T.C



ARTICLE #	LENGTH
15S-043	4 3/4" (12 cm)
15S-044	6" (15 cm)

Adson-Brown T.C

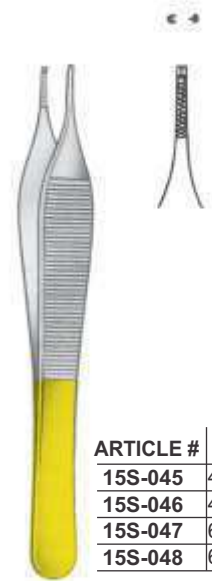

1 x 2

ARTICLE #	LENGTH	JAW
15S-045	4 3/4" (12 cm)	1,7 mm
15S-046	4 3/4" (12 cm)	1,0 mm
15S-047	6" (15 cm)	1,7 mm
15S-048	6" (15 cm)	1,0 mm

Micro-Adson T.C



Wangensteen Forceps T.C

ARTICLE #	LENGTH
15S-049	6" (15 cm)
15S-050	9" (23 cm)
15S-051	9 3/4" (25 cm)



15S-052
McIndoe Forceps
T.C 6" (15 cm)



Bayonet Forceps T.C

ARTICLE #	LENGTH
15S-053	5 1/2" (14 cm)
15S-054	6 1/2" (16 cm)



TUNGSTEN CARBIDE INSTRUMENTS (T.C)



ARTICLE #	LENGTH	JAW
15S-055	5½" (14,5 cm)	1,8 mm
15S-056	6½" (16 cm)	1,8 mm
15S-057	7" (18 cm)	1,8 mm
15S-058	8" (20 cm)	1,8 mm
15S-059	9" (23 cm)	1,8 mm
15S-060	10" (25 cm)	1,8 mm
15S-061	5½" (14,5 cm)	2,7 mm
15S-062	6½" (16 cm)	2,7 mm
15S-063	7" (18 cm)	2,7 mm
15S-064	8" (20 cm)	2,7 mm
15S-065	9" (23 cm)	2,7 mm

Dressing Forceps T.C



With Dissector:

ARTICLE #	LENGTH
15S-066	7" (18 cm)
15S-067	8 ¼" (21 cm)
15S-068	9" (23cm)
15S-069	10" (25 cm)

Potts-Smith Dressing Forceps T.C



Straight:

ARTICLE #	LENGTH	JAW
15S-070	7" (18 cm)	1,0 mm
15S-071	7" (18 cm)	2,0 mm

Cushing Dressing Forceps T.C

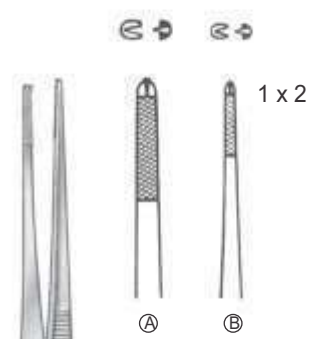

Ⓐ Standard:

ARTICLE #	LENGTH
15S-072	5½" (14,5 cm)
15S-073	6½" (16 cm)
15S-074	7" (18 cm)
15S-075	8" (20 cm)
15S-076	10" (25 cm)

Ⓑ Delicate:

ARTICLE #	LENGTH
15S-077	5½" (14,5 cm)
15S-078	6½" (16 cm)
15S-079	7" (18 cm)
15S-080	8" (20 cm)
15S-081	10" (25 cm)

Oehler Tissue Forceps T.C



15S-082 Bonney Tissue Forceps T.C 6 ¾" (17 cm)

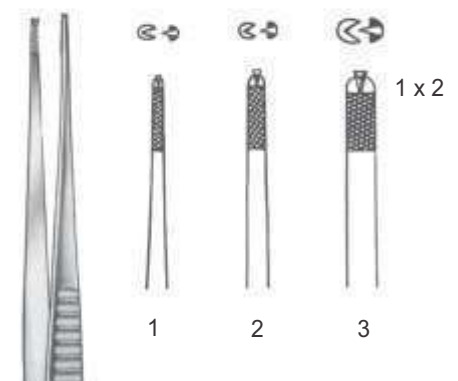

ARTICLE #	LENGTH	JAW
15S-083	9" (23 cm)	1
15S-084	9" (23 cm)	2
15S-085	9" (23 cm)	3

Skinner Tissue Forceps T.C



15S

TUNGSTEN CARBIDE INSTRUMENTS (T.C)



15S-086
Williams Tissue Forceps
T.C 8" (20 cm)



15S-087
Mod. USA, Dressing
Forceps T.C 8" (15 cm)



15S-088
Gillies Tissue Forceps T.C
6" (15 cm)



15S-089
Gerald Dressing
Forceps T.C 7" (18 cm)



15S-090
Gerald Tissue Forceps
T.C 7" (18 cm)



15S-091
Evans Tissue Forceps T.C
9" (25 cm)



15S

TUNGSTEN CARBIDE INSTRUMENTS (T.C)



15S-092
Derf Needle Holder
T.C 4 3/4" (12 cm)



15S-093
Halsey Needle Holder T.C

15S-093 5" (13 cm)
15S-094 5" (13 cm)



15S-095
Webster Needle
Holder T.C 5" (13 cm)



15S-096
Hegar-Baumgartner
Needle Holder T.C

15S-096 5" (13 cm)
15S-097 5 1/2" (14 cm)



Mayo-Hegar Needle Holder T.C

15S-098 5 1/2" (14 cm)
15S-099 6 1/4" (16 cm)
15S-100 7" (18 cm)
15S-101 8" (20 cm)



Crile-Wood Needle Holder T.C

15S-105 6" (15 cm)
15S-106 7" (18 cm)
15S-107 8" (20 cm)
15S-108 9" (23 cm)

15S-102 9 1/2" (24 cm)
15S-103 10" (26 cm)
15S-104 12" (30 cm)

15S-109 10" (26 cm)
15S-110 12" (30 cm)



De-Bakey Needle Holder T.C

15S-111 7" (18 cm)
15S-112 8" (20 cm)
15S-113 9" (23 cm)



15S-114 10" (26 cm)
15S-115 12" (30 cm)

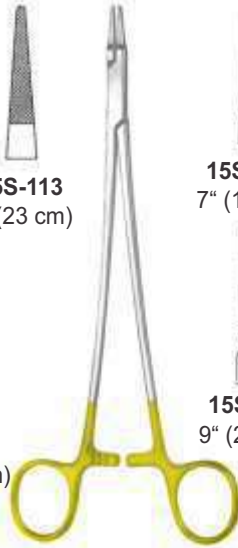

Intracardiac Needle Holder T.C

15S-116 7" (18 cm)
15S-117 8" (20 cm)

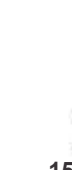

15S-118 9" (23 cm)
15S-119 10" (26 cm)



Olsen-Hegar Needle Holder T.C

15S-120 5 1/2" (14 cm)
15S-121 6 1/2" (16,5 cm)
15S-122 7" (18 cm)





15S

TUNGSTEN CARBIDE INSTRUMENTS (T.C)

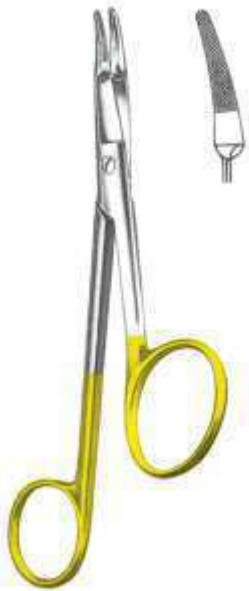

15S-123
Gillies Needle Holder
T.C 6½" (16 cm)



15S-124
Swedish Needle Holder
T.C 5½" (14,5 cm)



15S-125
Neivert Needle Holder
T.C 5" (13 cm)



15S-126
Tonnies Needle Holder
T.C 7½" (19 cm)



15S-127
5½" (14 cm)



15S-128
6 ¾" (17 cm)



15S-129
8" (20 cm)



15S-130
6 ¾" (17 cm)



15S-131
8" (20 cm)



15S-132
9" (23 cm)



15S-133
Zweifel Needle
Holder T.C 8" (20 cm)

Mathieu Needle Holder T.C

Mathieu Needle Holder T.C



15S

TUNGSTEN CARBIDE INSTRUMENTS (T.C)



15S-134
5½" (14 cm)



15S-135
5½" (14 cm)



15S-136
5½" (14 cm)



15S-137
5½" (14 cm)



15S-138
7" (18 cm)



15S-139
7" (18 cm)



15S-140
7" (18 cm)



15S-141
7" (18 cm)



15S-142
Kalt Needle Holder T.C
5¼" (13,5 cm)

Castroviejo
Needle Holder T.C

Castroviejo
Needle Holder T.C

Castroviejo
Needle Holder T.C

Castroviejo
Needle Holder T.C



15S-147
6 ¼" (16 cm)



15S-148
7" (18 cm)



15S-145
8 ¼" (21 cm)



15S-146
8 ¼" (21 cm)



15S-149
8" (20 cm)



15S-150
9" (23 cm)



15S-143
Castroviejo Blade
Breaker 5¼" (13 cm)

15S-144
Potts-Smith Blade
Breaker 8¼" (22 cm)

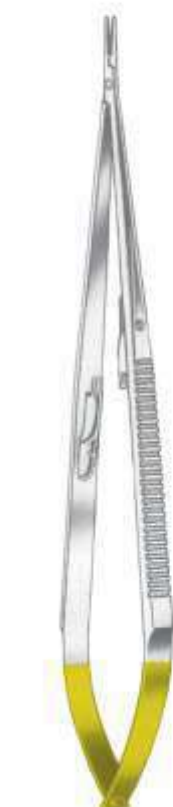

Jacobson Needle Holder T.C

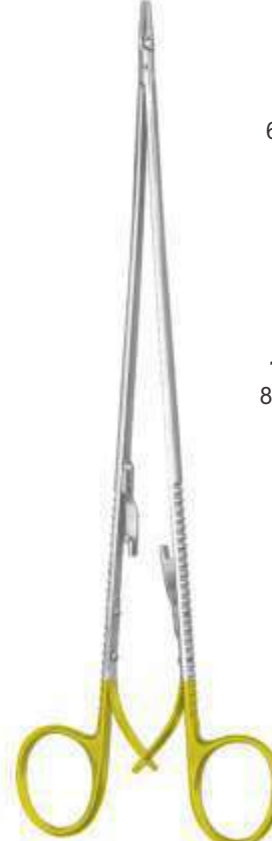

Diethrich Needle Holder T.C



15S-151
10 ¼" (26 cm)



15S

**TUNGSTEN CARBIDE INSTRUMENTS
(T.C)**



NEWMAX CORPORATION

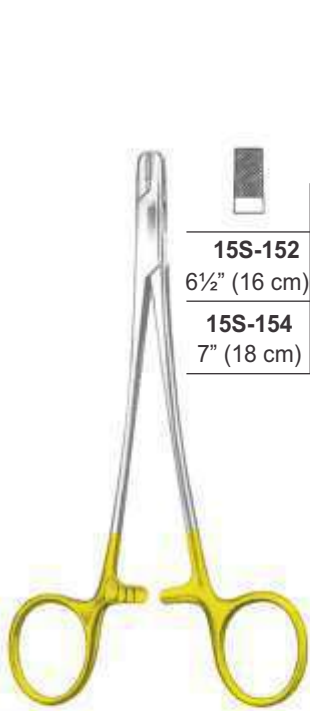

Wire Twisting Forceps

15S-152 6½" (16 cm)	15S-153 6½" (16 cm)
15S-154 7" (18 cm)	15S-155 7" (18 cm)

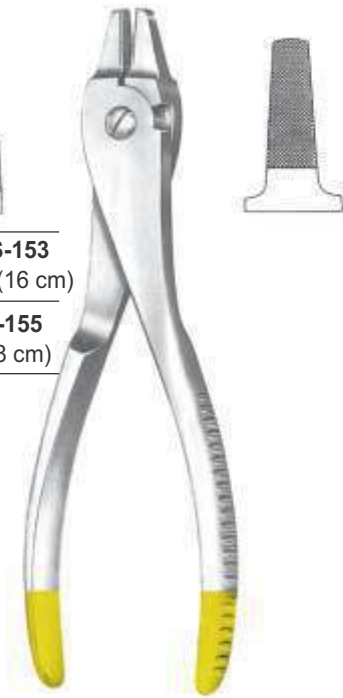

15S-156
Wire Holding
Plier 7" (18 cm)



Flat Nose Plier
7" (18 cm)



15S-160
Wire Cutting Plier
5½" (14 cm)



15S-161
Mini Wire
Cutting Plier
6½" (16 cm)



15S-162
Cotting Plier Front and
Side Cutter 7" (18 cm)



15S-163
Wire Cutting Plier
9" (23 cm)



15S-164
Bone Plate Cutter
9½" (24 cm)

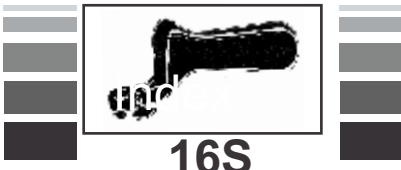

LASER SURGERY INSTRUMENTS



Available in Black & Blue Laser Coating

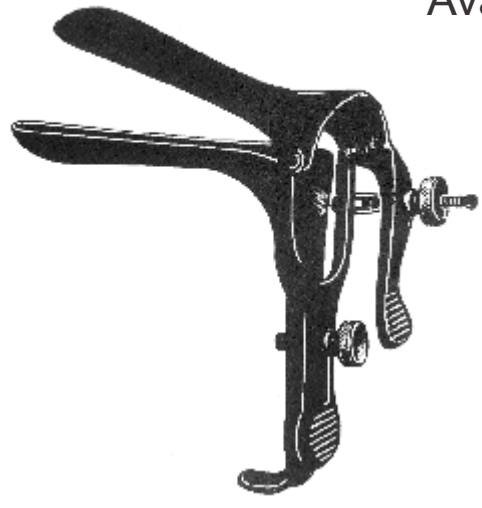

Laser Graves Vaginal Speculum

16S-001	3" x 3/4"	Small
16S-002	4" x 1 1/4"	Medium
16S-003	4 1/2" x 1 3/8"	Large
16S-004	3" x 1/2"	Extra Small
16S-005	4 1/4" x 1 1/2"	Extra Large

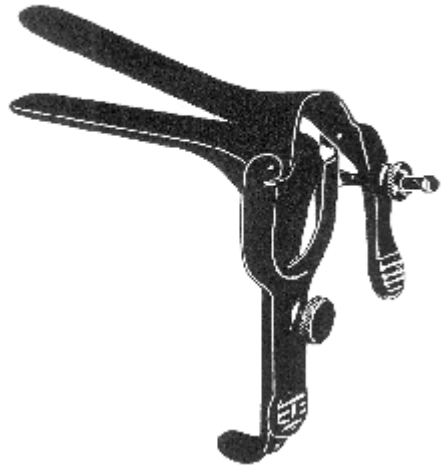

Laser Pederson Vaginal Speculum

16S-006	3" x 1/2"	Small
16S-007	4 3/4" x 1"	Large
16S-008	4" x 5/8"	Slender
16S-009	4" x 7/8"	Medium
16S-010	2 3/4" x 5/8"	Extra Small



Laser Cusco Vaginal Speculum

16S-011	3" x 1/4"	Small
16S-012	3 3/8" x 1"	Medium
16S-013	3 3/4" x 5/8"	Large



Laser Collin Vaginal Speculum

16S-014	1 1/4" x 3 3/4"	Small
16S-015	1 3/8" x 4"	Medium
16S-016	1 3/4" x 4 1/2"	Large



Laser Auvard Vaginal Speculum

16S-017	2 1/2 lbs. Without loop	Medium
16S-018	2 1/2 lbs. With loop	Medium

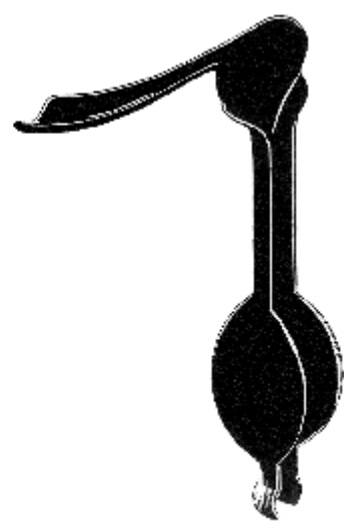

Laser Steiner-Auvard Vaginal Speculum

16S-019	2 1/2 lbs. Without loop	Medium
16S-020	2 1/2 lbs. With loop	Medium



16S-021

Laser Lateral Vaginal Speculum 8 1/4" (21 cm)

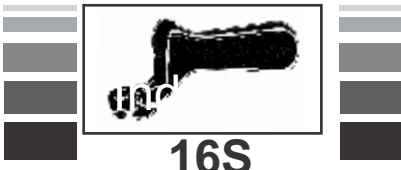

LASER SURGERY INSTRUMENTS



Available in Black & Blue Laser Coating

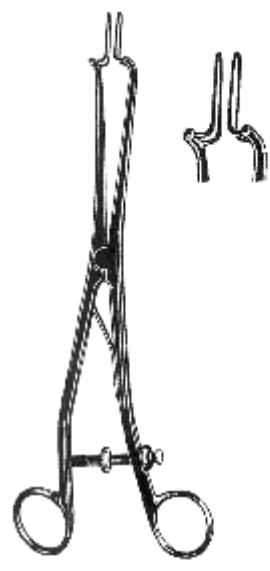

Laser Kogan Endospeculum

16S-022	9½" (24 cm)
16S-023	11" (28 cm)

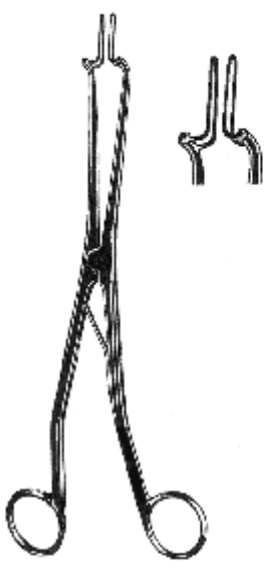

Laser Kogan Endospeculum

16S-024	9½" (24 cm)
16S-025	11" (28 cm)



Laser Kogan Endospeculum

16S-026	9½" (24 cm)
16S-027	11" (28 cm)



16S-028
Laser Kogan
Endospeculum 9"
(23 cm)



16S-029

Laser Champion Grasping Forceps
Curved 9" (23cm)



16S-030

Laser Bozeman Forceps
One Large Ring 10" (25 cm)



16S-031

Laser Bozeman
Forceps S-Curve
10" (25 cm)



Laser Schroeder Tenaculum Forceps

16S-032	9½" (24 cm)	(Braun)
16S-033	10 ¼" (26 cm)	(Pozzi)



16S-034

Laser Babcock
Forceps 8" (20
cm)

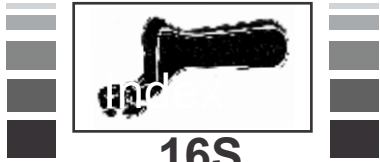

LASER SURGERY INSTRUMENTS



Available in Black & Blue Laser Coating



16S-035
Laser Schweizer
Forceps Straight 9 1/2"
(24 cm)

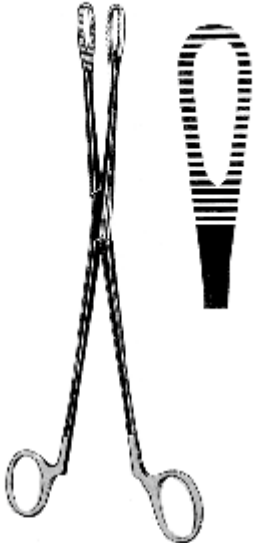

16S-036
Laser Clemestson
Forceps 9 1/2" (24 cm)



16S-037
Laser Laufe Uterine Polyp
Forceps Curved 7 3/4" (19,5 cm)



16S-038
Laser Heaney Needle
Holder 8 1/4" (21 cm)

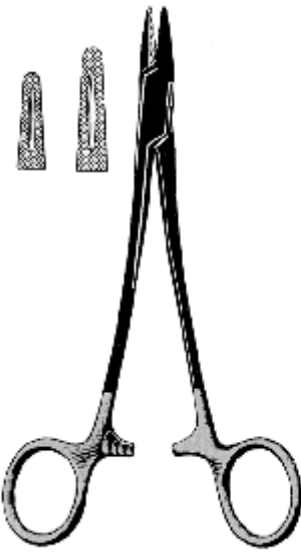

Laser Mayo-Hegar Needle Holder

16S-039	7" (18 cm)
16S-040	8" (20 cm)



16S-041
Laser Jackson
Retractor 3 1/2" x 1 1/2"

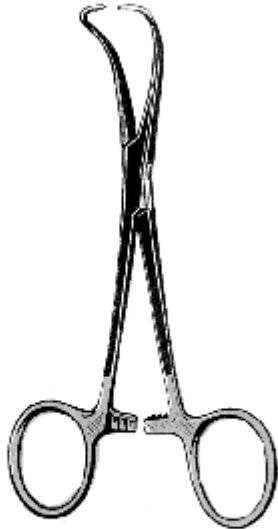

Laser Backhaus Towel Clamp

16S-043	3 1/2" (9 cm)
16S-044	5 1/4" (13 cm)



16S

LASER SURGERY INSTRUMENTS

Available in Black & Blue Laser Coating



Laser Allis Tissue Forceps

16S-045	5" (12,5 cm)	Baby Allis
16S-046	7½" (19 cm)	Allis, 5 x 6
16S-047	9½" (24 cm)	Allis, 5 x 6



Potts-Smith Forceps

16S-048	7" (18 cm)	Serrated
16S-049	10" (25 cm)	Serrated



De-Bakey Atraumatic Tissue Forceps
2,0 mm Jaws

16S-050	7¼" (19,5 cm)
16S-051	9½" (24 cm)



Laser Tuttle / Singly Forceps

16S-052	7" (18 cm)	Tuttle
16S-053	9" (23 cm)	Singly



16S-054
Laser Adson Tissue
Forceps Serrated,
4¾" (12 cm)



Laser Rochester-Pean Forceps

16S-055	7¼" (18,5 cm)	Straight
16S-056	7¼" (18,5 cm)	Curved



17S

HOLLOWWARE



Forceps Jar

ARTICLE #	SIZE
17S-001	2" x 5"
17S-002	4" x 8"



17S-003
Oiment Jar
Size: 08oz



17S-004
Cotton Wool Dispenser



17S-005
Cotton Wool Dispenser



17S-006
Alcohol Lamp

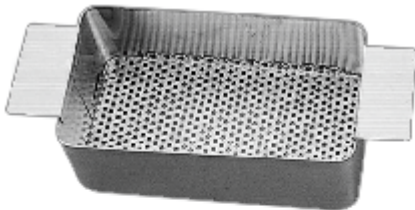

17S-007
Sterilizing Tray
8½" x 4½" x 3"



Kidney Tray

ARTICLE #	SIZE
17S-008	150 mm
17S-009	170 mm
17S-010	200 mm
17S-011	250 mm
17S-012	280 mm
17S-013	300 mm



Instrument Tray

ARTICLE #	SIZE
17S-014	150 x 100 x 40 mm
17S-015	200 x 150 x 40 mm
17S-016	255 x 200 x 40 mm
17S-017	300 x 150 x 40 mm
17S-018	300 x 200 x 50 mm
17S-019	300 x 255 x 50 mm
17S-020	310 x 200 x 60 mm
17S-021	330 x 250 x 50 mm
17S-022	355 x 255 x 50 mm
17S-023	355 x 300 x 50 mm
17S-024	400 x 300 x 55 mm
17S-025	460 x 300 x 55 mm
17S-026	460 x 360 x 55 mm



Instrument Tray with Lid

ARTICLE #	SIZE
17S-027	150 x 100 x 40 mm
17S-028	200 x 150 x 40 mm
17S-029	255 x 200 x 40 mm
17S-030	300 x 150 x 40 mm
17S-031	300 x 200 x 50 mm
17S-032	300 x 255 x 50 mm
17S-033	310 x 200 x 60 mm
17S-034	330 x 250 x 50 mm
17S-035	355 x 255 x 50 mm
17S-036	355 x 300 x 50 mm
17S-037	400 x 300 x 55 mm
17S-038	460 x 300 x 55 mm
17S-039	460 x 360 x 55 mm



Cathiter Tray

ARTICLE #	SIZE
17S-040	300 x 75 x 40 mm
17S-041	350 x 90 x 50 mm
17S-042	400 x 100 x 50 mm



Mayo Tray

ARTICLE #	SIZE
17S-043	400 x 300 x 20 mm
17S-044	450 x 320 x 20 mm
17S-045	460 x 360 x 20 mm



17S

HOLLOWWARE

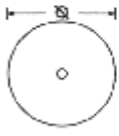

Cotton Wool Container

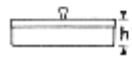

Lid with Knob

Ø x h	
75 x 60	17S-046
75 x 75	17S-047
100 x 60	17S-048
100 x 100	17S-049
125 x 80	17S-050
125 x 125	17S-051
150 x 150	17S-052

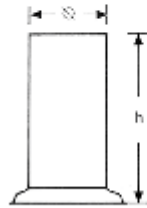

JAR

Ø x h	Jar without Lid	Lid Only	Lid Only with Triangle hole
30 x 90	17S-053		
50 x 100	17S-054	17S-061	17S-068
50 x 130	17S-055	17S-062	17S-069
50 x 175	17S-056	17S-063	17S-070
75 x 100	17S-057	17S-064	17S-071
75 x 130	17S-058	17S-065	17S-072
100 x 175	17S-059	17S-066	17S-073
100 x 200	17S-060	17S-067	17S-074

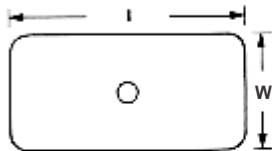

Instrument Box

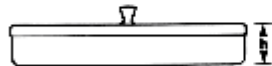

Size in mm l x b x h	Lid with Knob	Lid without Knob
165 x 85 x 35	17S-075	17S-083
200 x 100 x 35	17S-076	17S-084
200 x 100 x 50	17S-077	17S-085
230 x 130 x 50	17S-078	17S-086
260 x 150 x 50	17S-079	17S-087
270 x 235 x 50	17S-080	17S-088
300 x 200 x 50	17S-081	17S-089
325 x 275 x 50	17S-082	17S-090



17S-091 Bucket
Only Size:
Dia: 335 mm
Height: 240 mm
Base: 215 mm

17S-092
Bucket Kick
Stand (Stand
Only)



17S

HOLLOWWARE



Sterilizer Drum

ARTICLE #	SIZE
17S-093	80 x 80 mm
17S-094	120 x 120 mm
17S-095	140 x 140 mm
17S-096	160 x 120 mm
17S-097	160 x 150 mm
17S-098	190 x 150 mm
17S-099	190 x 190 mm
17S-100	240 x 160 mm
17S-101	240 x 240 mm
17S-102	290 x 160 mm
17S-103	290 x 240 mm
17S-104	340 x 160 mm
17S-105	340 x 240 mm
17S-106	390 x 190 mm
17S-107	390 x 290 mm



Emises Basin

17S-108	12" (4 LTR)
17S-109	13" (6 LTR)
17S-110	14" (8 LTR)



17S-111
Urinal - Male



17S-112
Urinal - Female



17S-113
Bedpan Slipper Type



17S-114
Bedpan American

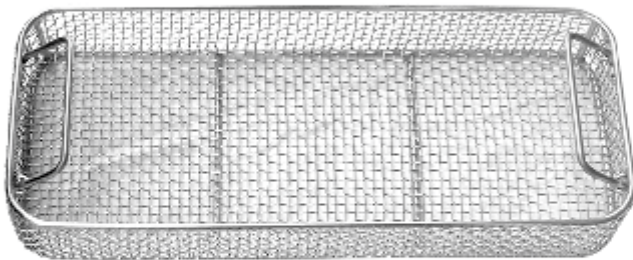

Wire Mesh Tray

ARTICLE #	SIZE
17S-115	230 x 130 x 50 mm
17S-116	240 x 130 x 50 mm
17S-117	240 x 250 x 60 mm
17S-118	480 x 250 x 50 mm
17S-119	480 x 250 x 70 mm
17S-120	500 x 300 x 50 mm
17S-121	480 x 480 x 50 mm
17S-122	300 x 300 x 60 mm
17S-123	500 x 300 x 60 mm
17S-124	600 x 300 x 60 mm



Sterilizing Container

ARTICLE #	SIZE
17S-125	220 x 120 x 50 mm
17S-126	230 x 130 x 50 mm
17S-127	260 x 150 x 50 mm
17S-128	300 x 200 x 50 mm



01D

EXTRACTING FORCEPS (American Pattern)

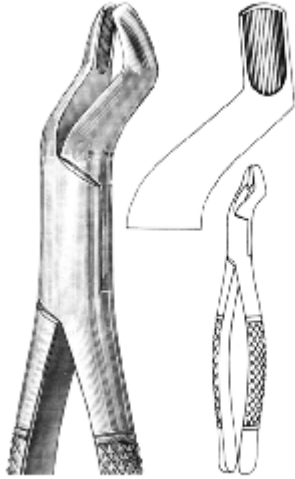

01D-001
Upper Molars,
Universal # 10S

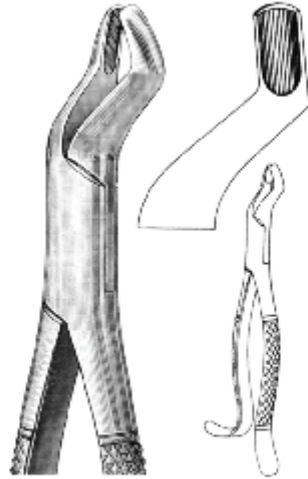

01D-002
Upper Molars, Hook
Handle, Universal # 10H

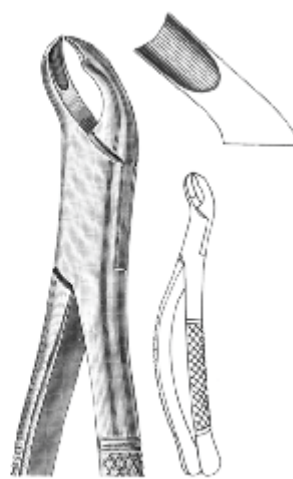

01D-003
Upper Molars,
Left # 90

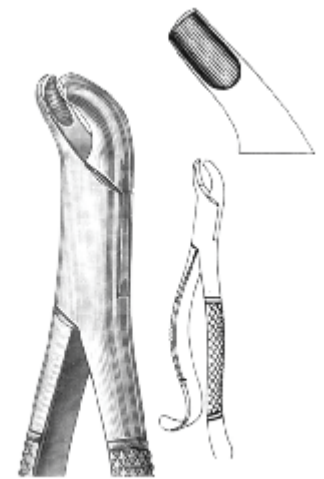

01D-004
1st & 2nd Upper
Molar, Left # 18L

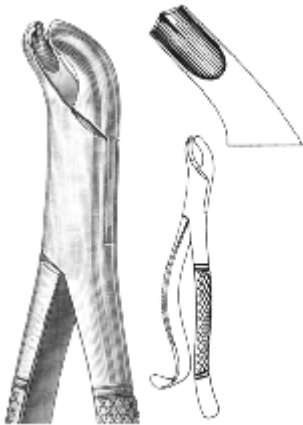

01D-005
1st & 2nd Upper
Molar, Right # 18R

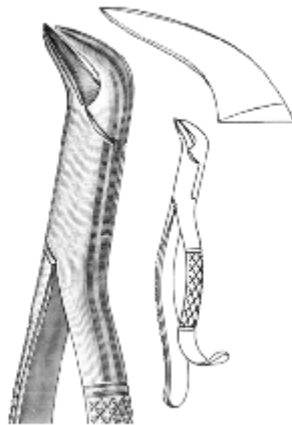

01D-006
1st & 2nd Lower
Molars, Universal,
Cow Horn # 16

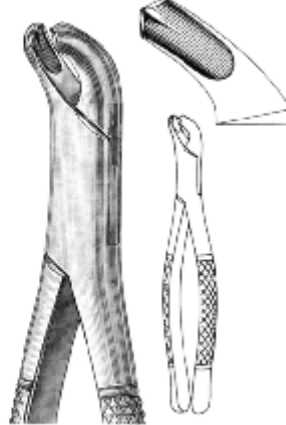

01D-007
1st & 2nd Lower
Molars, Universal # 17

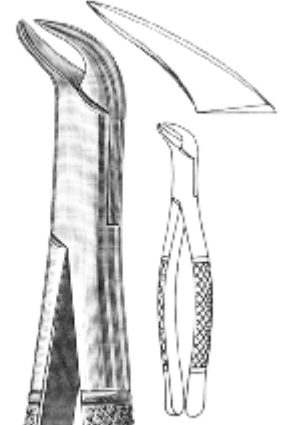

01D-008
1st & 2nd Lower Molars,
Universal, Cow Horn # 23

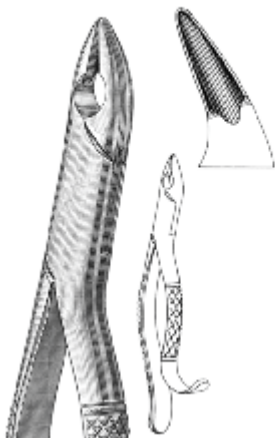

01D-009
Lower Molars, Cuspids
& Bicuspids, Universal # 85

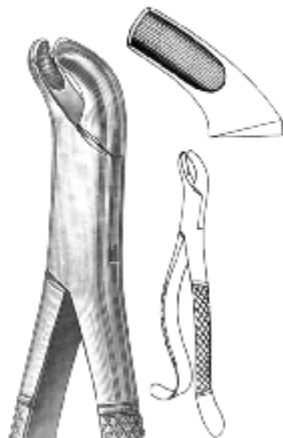

01D-010
Upper Molars,
Universal # 24

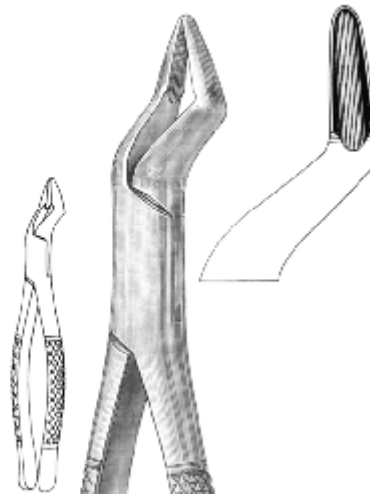

01D-011
Upper Cuspid, Bicuspids
& Molars, Universal # 32

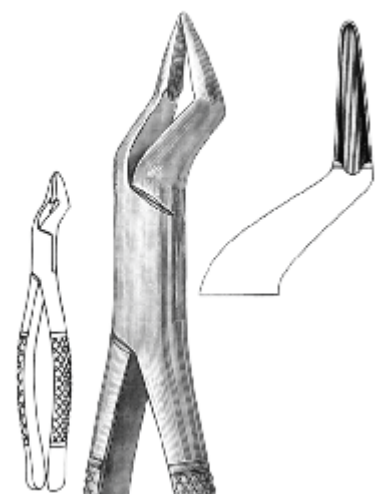

01D-012
Upper Cuspid, Bicuspids
& Molars, Universal # 32A



01D

EXTRACTING FORCEPS

(American Pattern)



NEWMAX CORPORATION

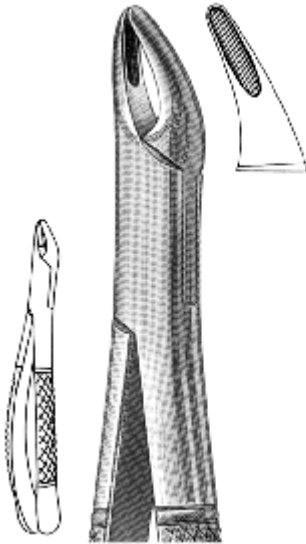

01D-013

Upper Incisors, Cuspid,
Bicuspids & Roots;
Universal # 150

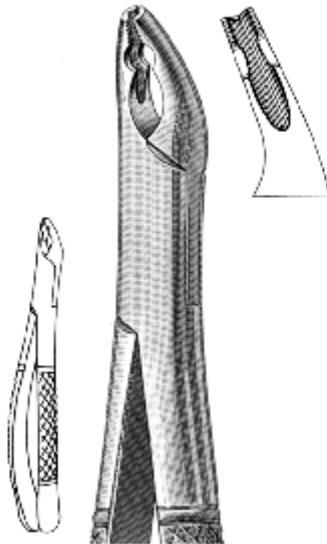

01D-014

Upper Anteriors; Split
Beaks; Serrated # 150AS

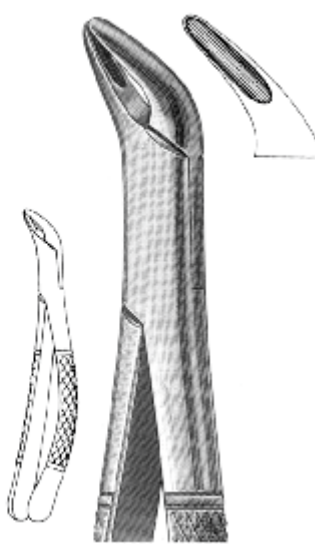

01D-015

Lower Incisors, Cuspid,
Bicuspids & Roots;
Universal # 151

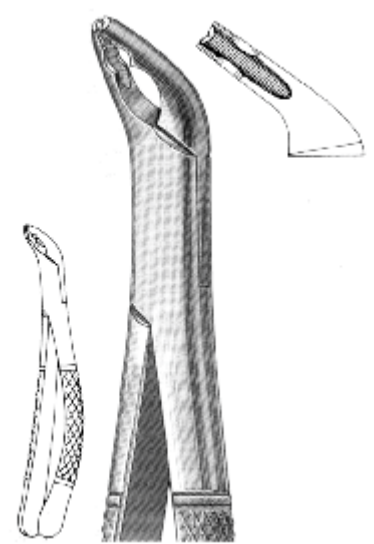

01D-016

Lower Anteriors; Split
Beaks; Serrated # 151 AS

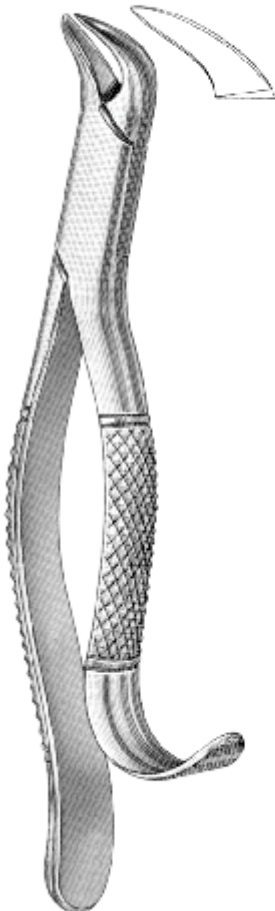

01D-017

Pedo Lower Molars,
Cow Horn # 16S

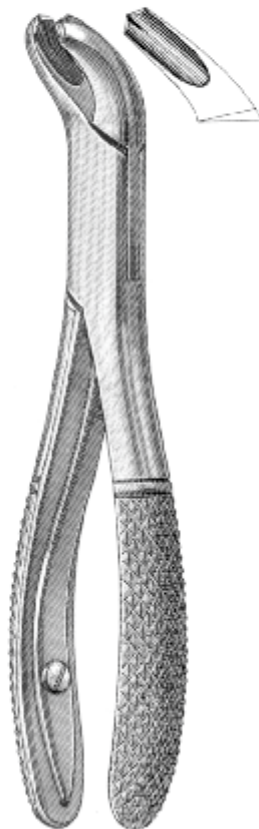

01D-018

Pedo Lower Molars
Universal, Spring
Handle # 17S

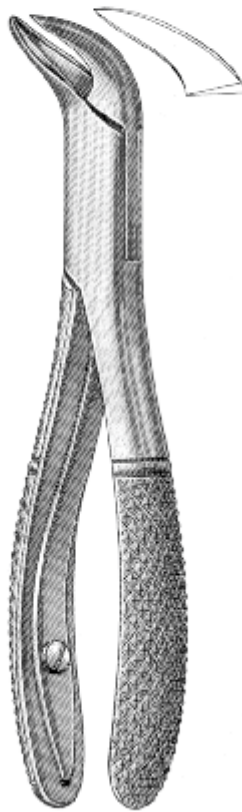

01D-019

Pedo Lower Molars
Universal, Cow Horn,
Spring Handle # 23S

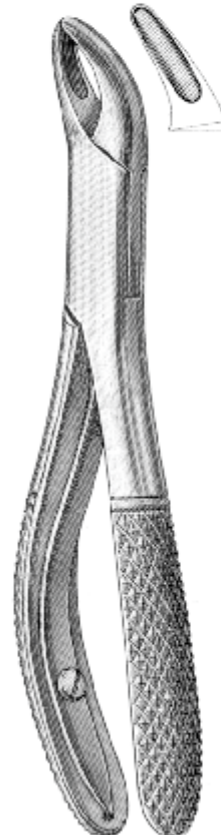

01D-020

Pedo Upper Incisors, Bicuspid
& Roots, Universal, Spring Handle
150½S

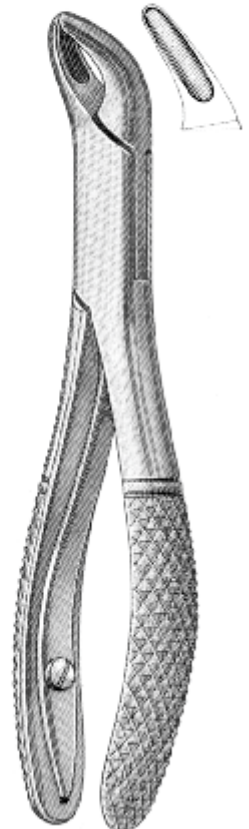

01D-021

Pedo Lower Incisors, Bicuspid
Roots, Universal, Spring Handle
151½S



01D

EXTRACTING FORCEPS (European Pattern)

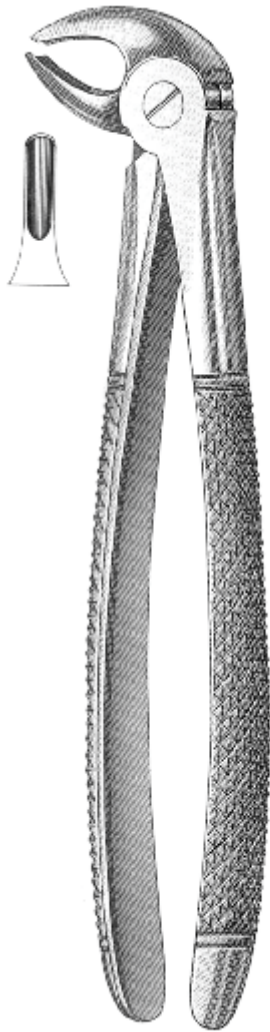

01D-022
Lower Bicuspids,
Universal # 13

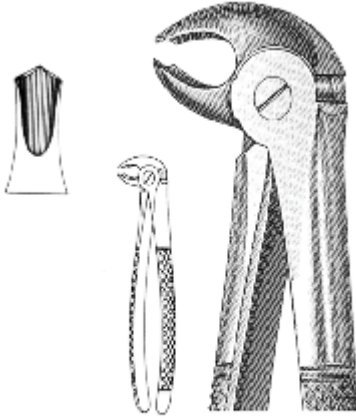

01D-023
Lower Molars,
Universal # 22

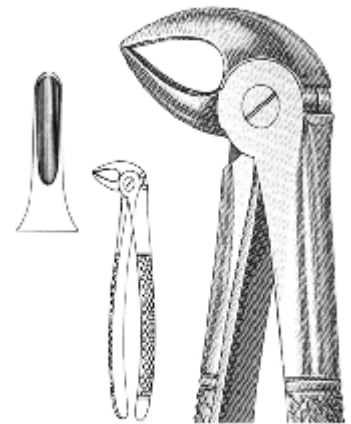

01D-024
Lower Roots # 23



01D-025
Lower Roots,
Narrow Beaks # 27



01D-026
Lower Molars,
Universal # 73



01D-027
Lower Roots # 74

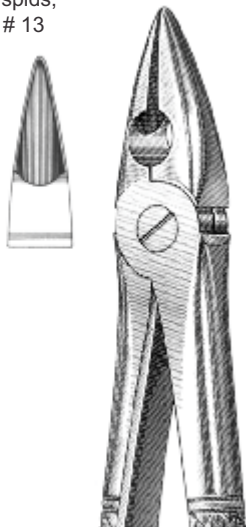

01D-028
Upper Incisors, Cuspids,
Bicuspids and Roots,
Mead, Universal # MD1

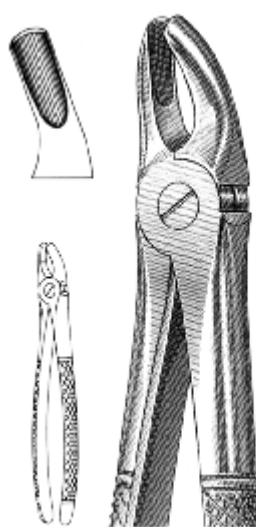

01D-029
Upper 1st, 2nd and 3rd
Molars, Mead, Universal #
MD2

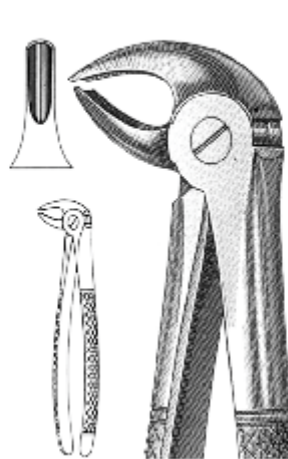

01D-030
Lower Incisors, Cuspids,
Bicuspids and Roots,
Mead, Universal # MD3

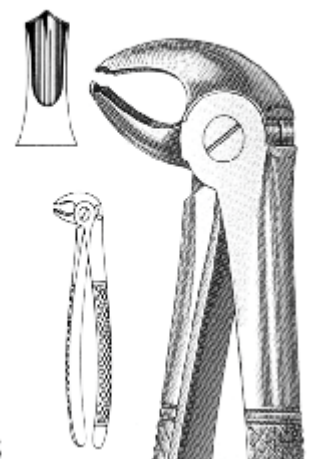

01D-031
Lower 1st, 2nd and 3rd
Molars, Mead, Universal # MD4



02D

ELEVATORS

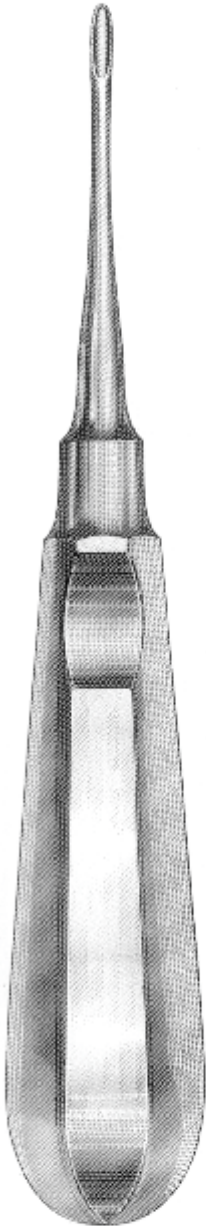

02D-001



02D-002



02D-003



02D-004

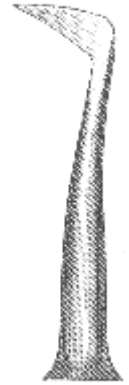

02D-005

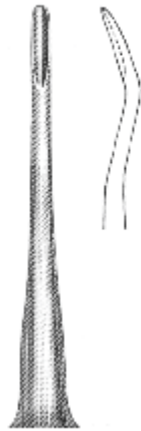

02D-006

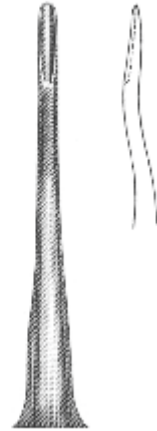

02D-007

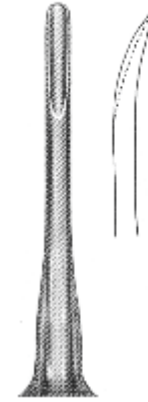

02D-008

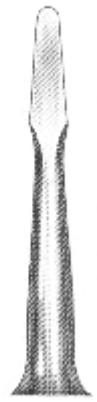

02D-009



02D-010



02D-011



02D-012

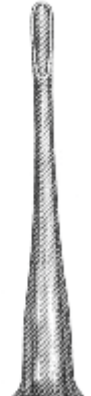

02D-013



02D

ELEVATORS

Root Tip

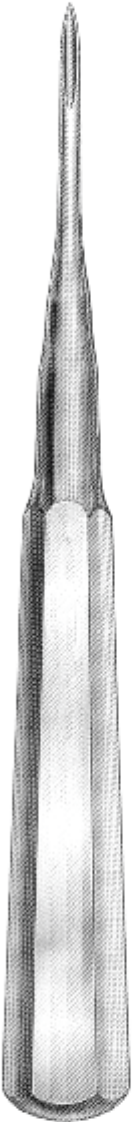

02D-014



02D-015



02D-016

Heidbrink Root-Tip Picks

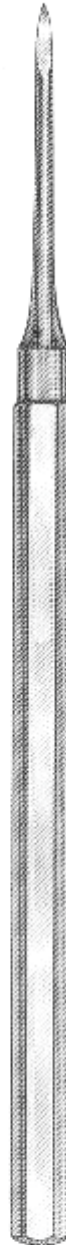

02D-017



02D-018



02D-019



02D-020

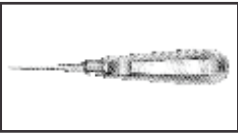

02D

ELEVATORS

Potts Elevator

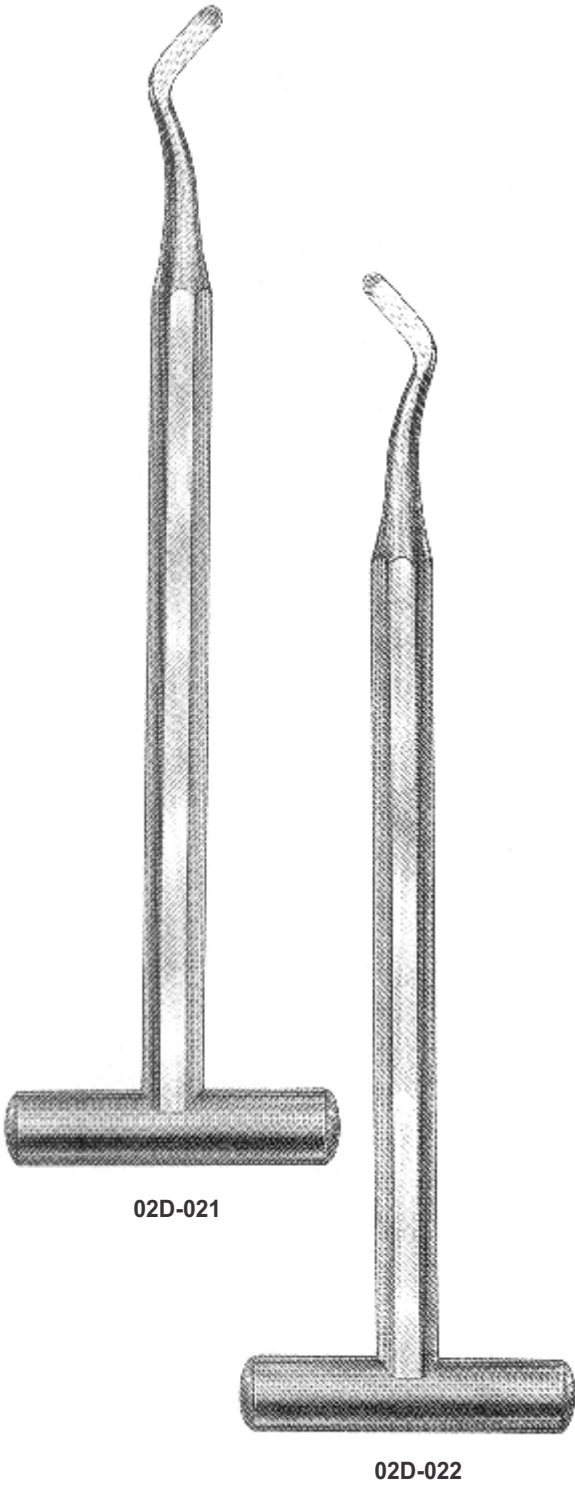

Priosteal Elevator

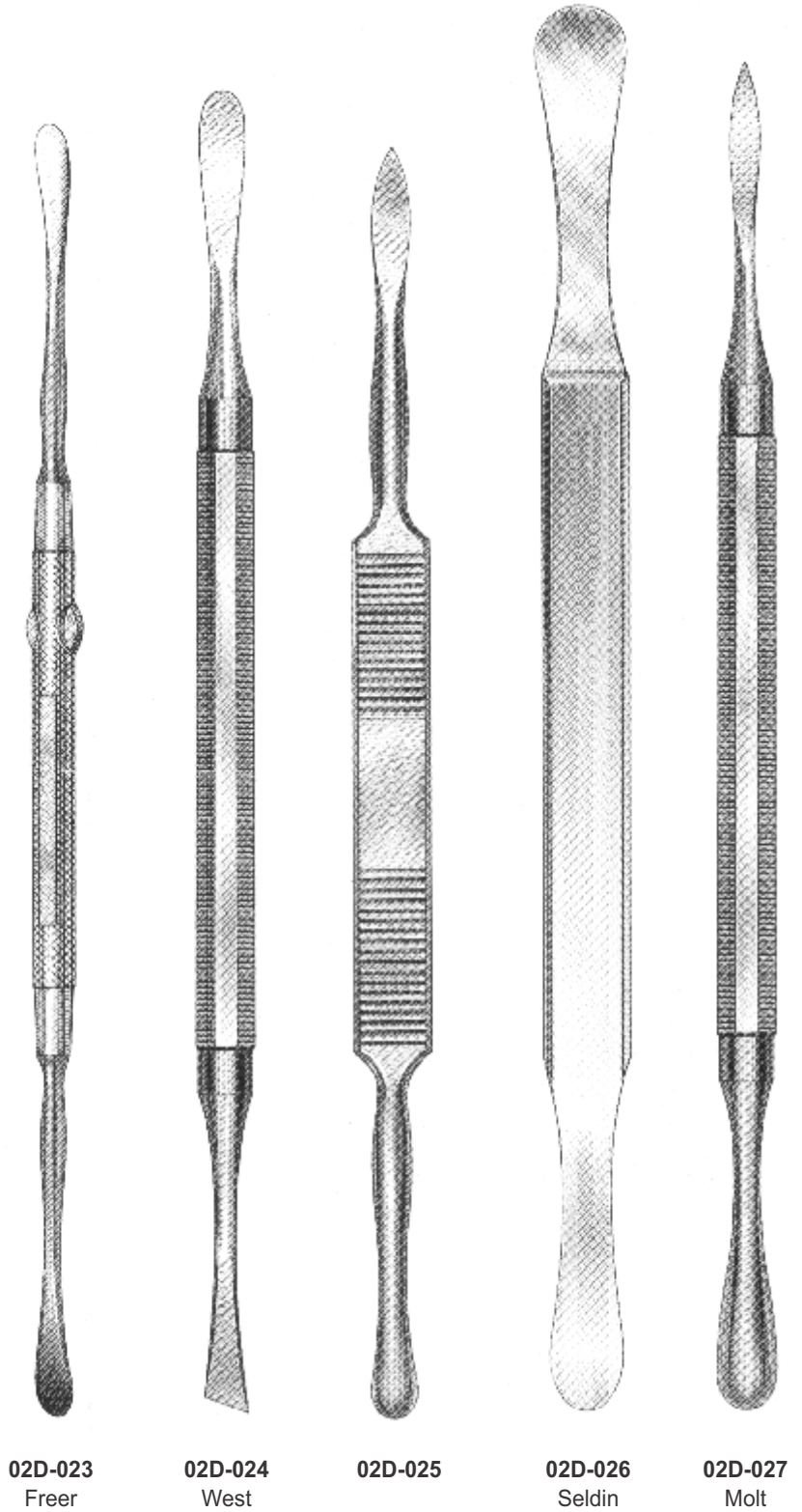

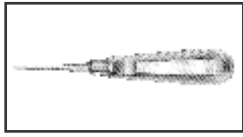

02D

ELEVATORS



NEWMAX CORPORATION

Lucas

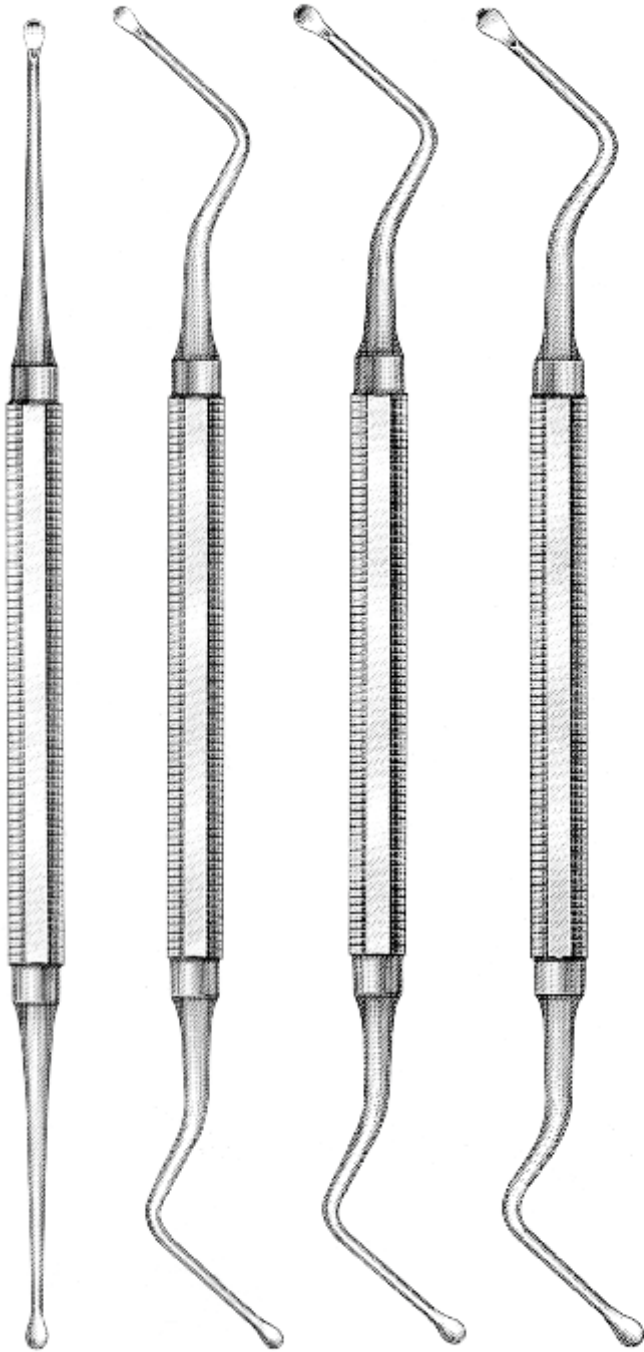

02D-028

02D-029

02D-030

02D-031

Muli

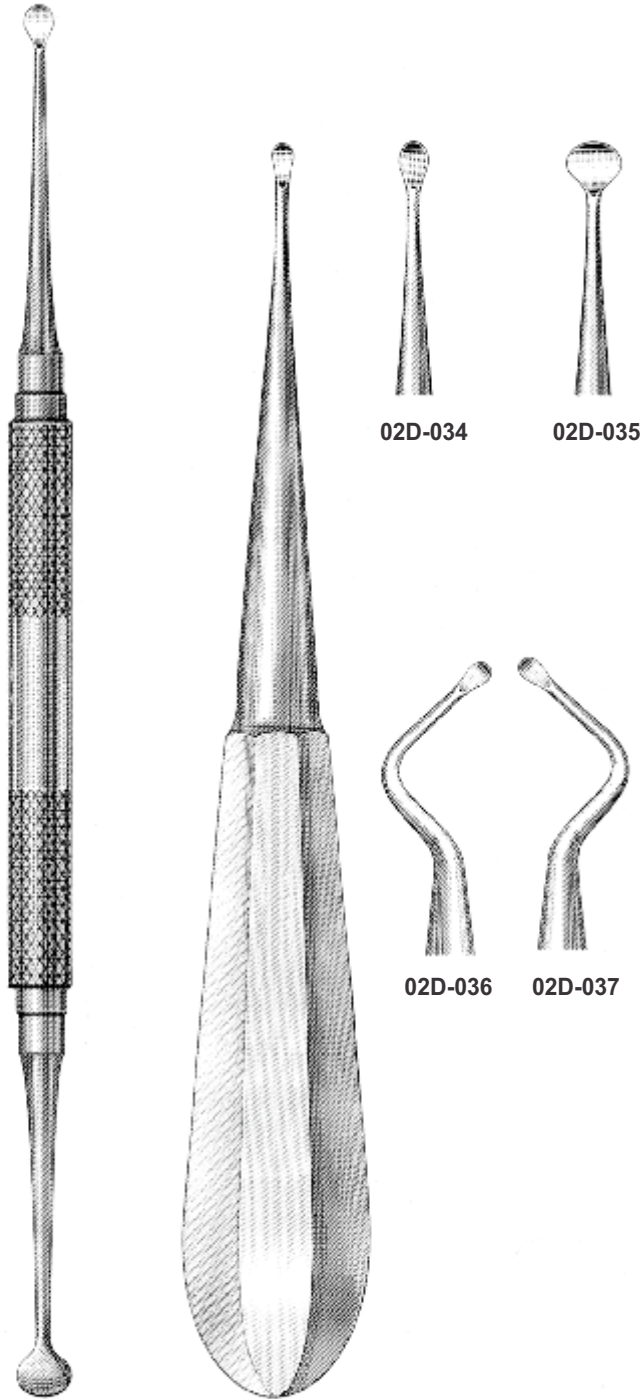

02D-034

02D-035

02D-036

02D-037

02D-032

02D-033

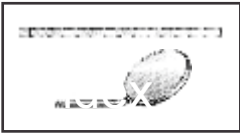

03D

MIRROR + HANDLE



**CONE SOCKET
Mirror Only**

03D-	#
001	3
03D-	#
002	4
03D-	#
003	5



**SIMPLE STEM
Mirror Only**

03D-	#
004	3
03D-	#
005	4
03D-	#
006	5

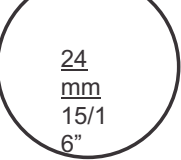
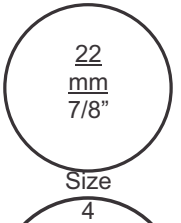
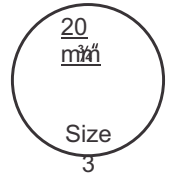

03D-007
Octagonal Dental Mirror Handle



03D-008
Delux Dental Mirror Handle



03D-009
Octagonal Dental Mirror Handle, with millimeter rule

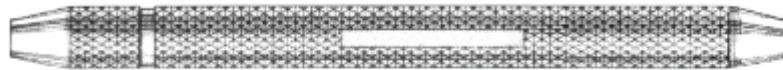

03D-010
Double End Dental Mirror Handle



03D-011
Autoclavable Front Surface Fiberglass Mirror



04D

AMALGAM CARRIERS & SYRINGES

Amalgam Carriers Swiss Pattern

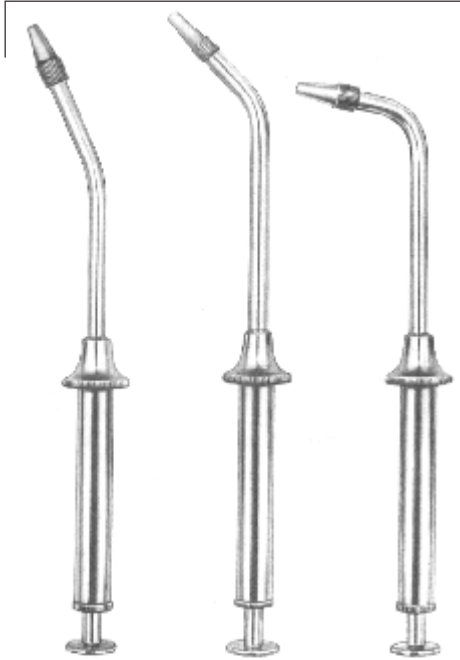

04D-001

04D-002

04D-003

Amalgam Carriers

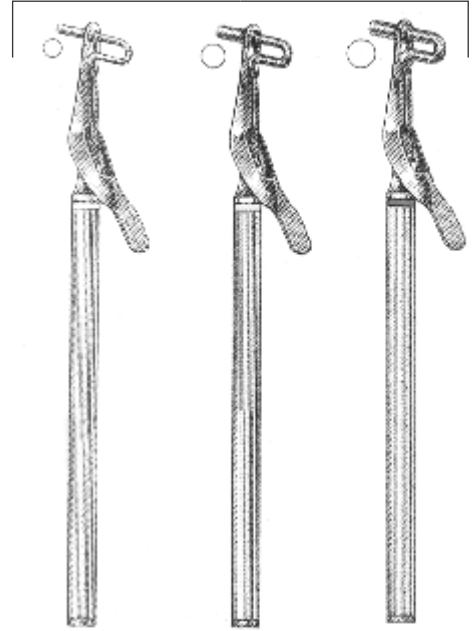

04D-004
Small

04D-005
Medium

04D-006
Large

Amalgam Carriers (Double End)

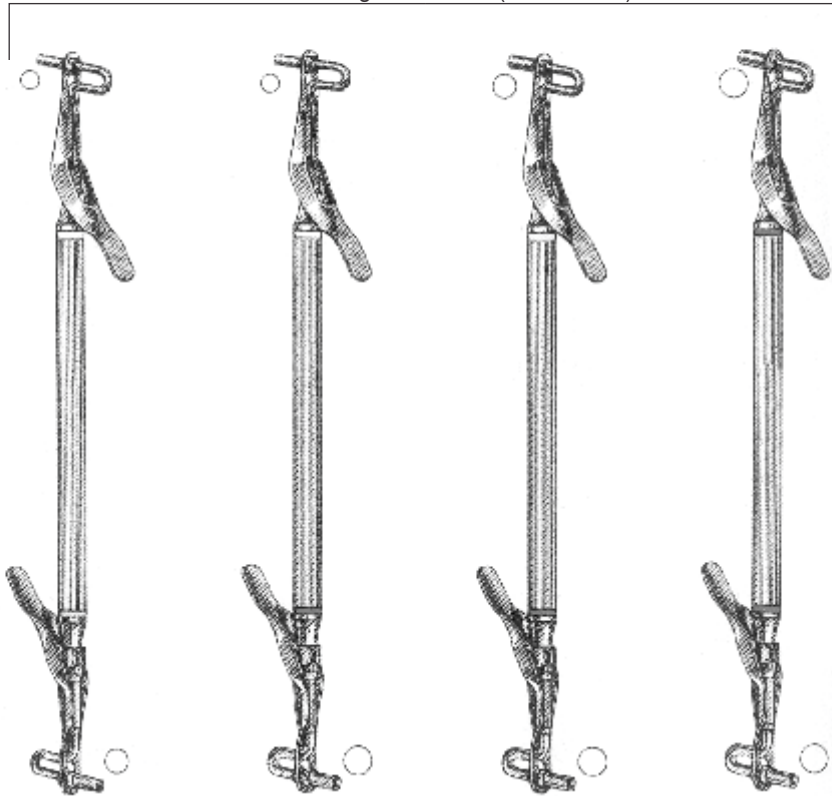

04D-007
Large/Medium

04D-008
Small/Large

04D-009
Medium/Large

04D-010
Large/Large

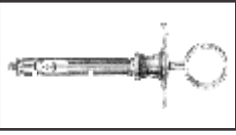

04D

AMALGAM CARRIERS & SYRINGES

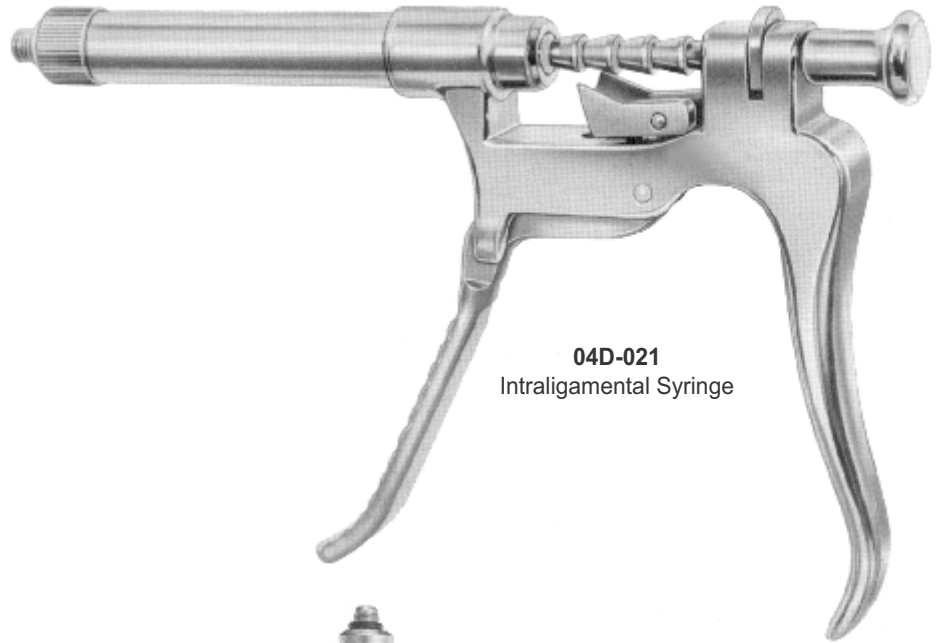

04D-021
Intraligamental Syringe

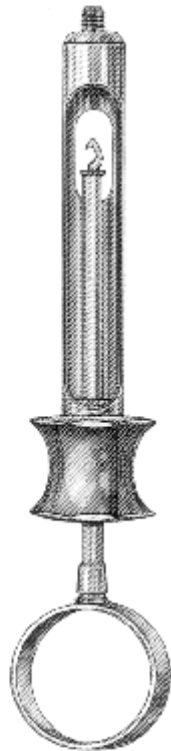

Aspirating Syringe

04D-013	1,8 cc
04D-014	2,2 cc

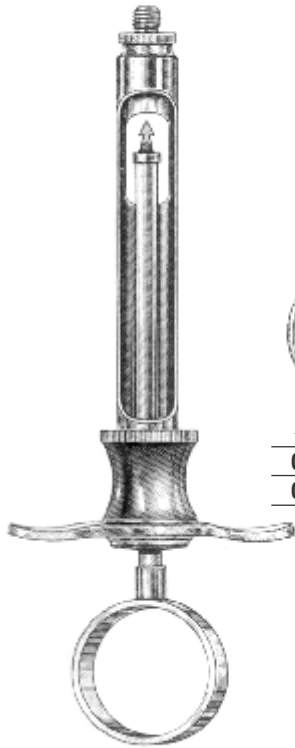

Aspirating Syringe

04D-011	1,8 cc
04D-012	2,2 cc

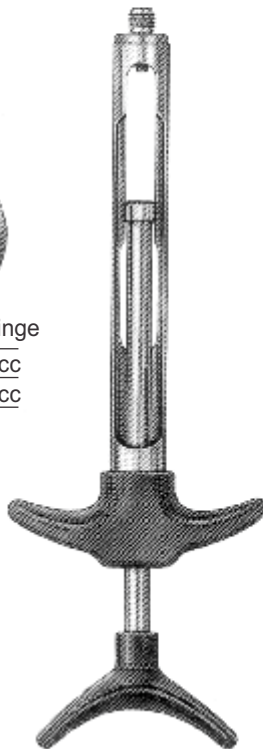

Self-Aspirating Syringe

04D-015	1,8 cc
04D-016	2,2 cc



Self-Aspirating Syringe

04D-017	1,8 cc
04D-018	2,2 cc



Articulating Barrel Syringe
(Shown Open)

04D-019	1,8 cc
04D-020	2,2 cc



05D

MISCELLANEOUS



05D-001
Cow Horn



05D-002
Stiff Blade



05D-003
Stiff Blade



05D-004
Extra Stiff Blade



05D-005
Flexible Blade



05D-006
Ball Chain



05D-007
Non-Chill
Clear
Plastic

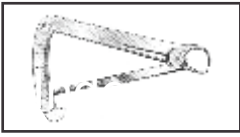

06D

TUFFLIMIRE, CALIPERS ETC



06D-008



06D-009

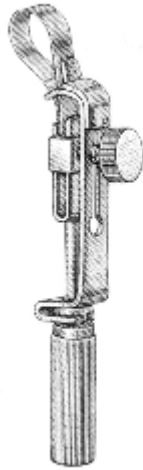

06D-010



06D-011
JUNIOR-CA



06D-012
SENIOR-CA

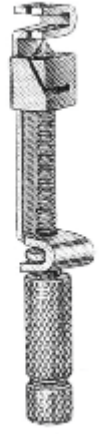

06D-013
Universal

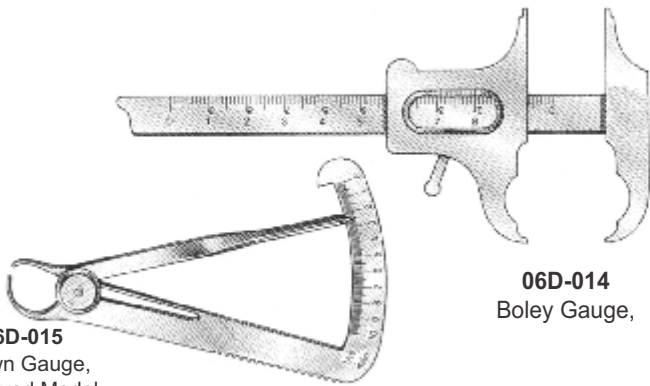

06D-014
Boley Gauge,

06D-015
Crown Gauge,
Improved Model
with 2 Sided Scale

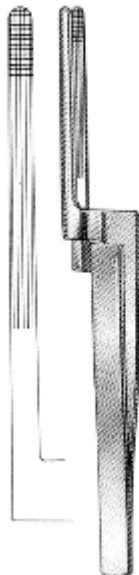

06D-016
Standard Articulating Paper Forceps,

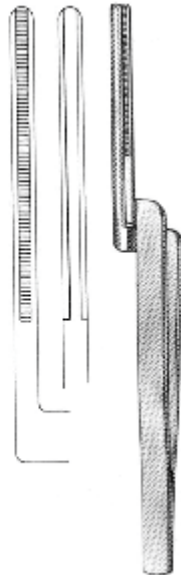

06D-017
POSIGRIP Articulating
Paper Forceps,



06D-018
London College Tweezer
Smooth
6" (15 cm)



06D-019
London College Tweezer
Serrated
6" (15 cm)



06D-020
London College Tweezer
Serrated/with lock
6" (15 cm)



06D-021
Meriam Serrated
6 1/4" (16 cm)



06D-022
Meriam Smooth
6 1/4" (16 cm)



GENERAL DENTISTRY INSTRUMENTS

07D

GRACEY CURETTE

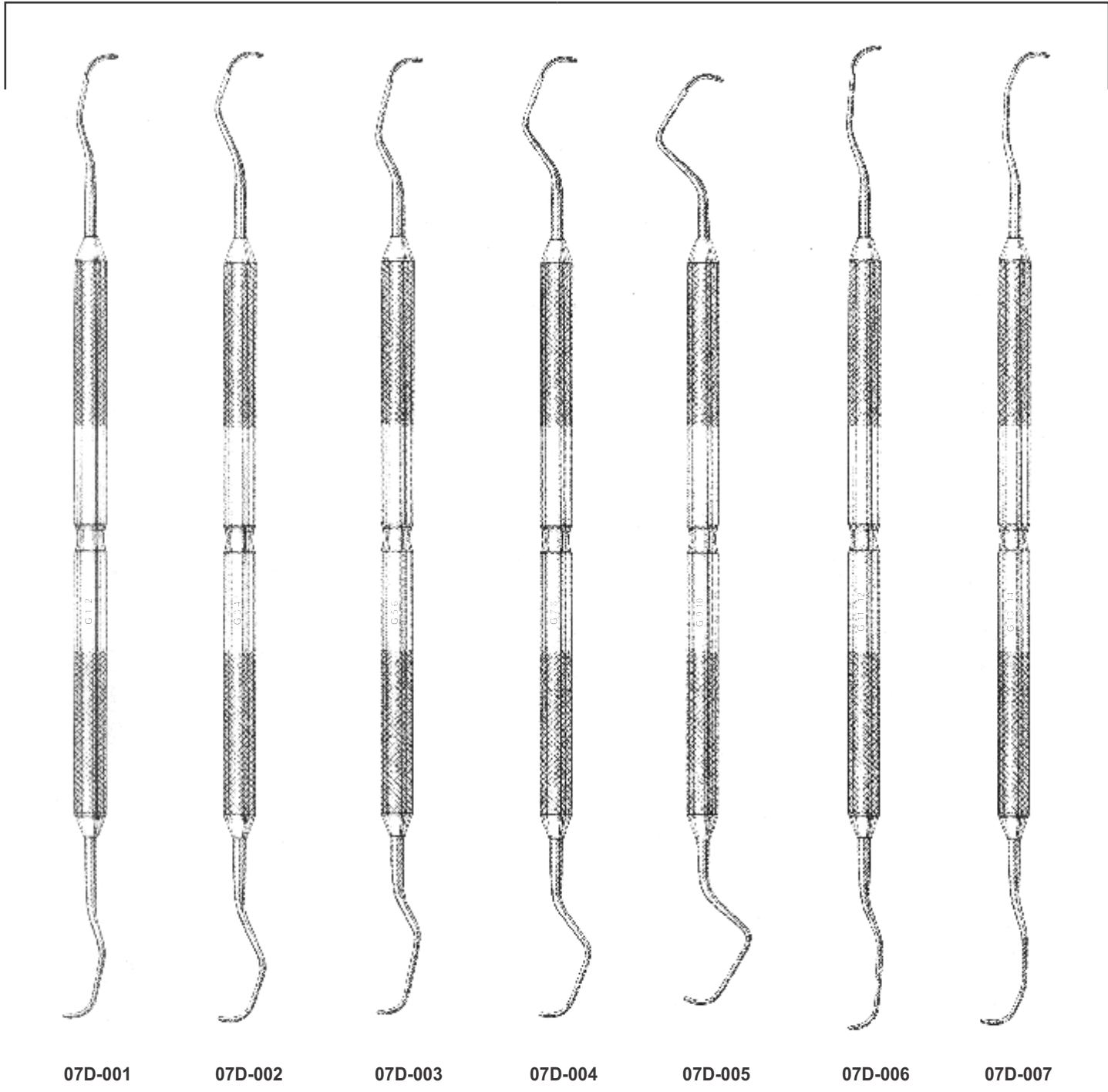



07D

GENERAL DENTISTRY INSTRUMENTS



COLUMBIA CURETTES

MCCALLS CURETTES

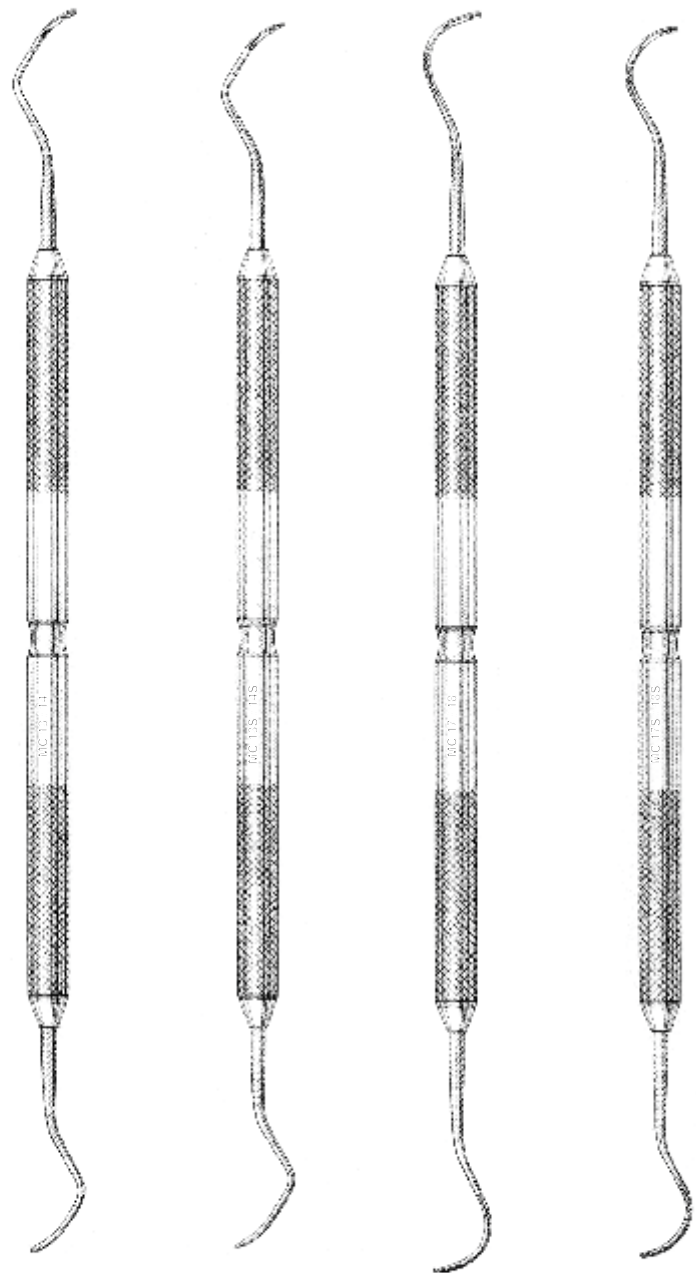
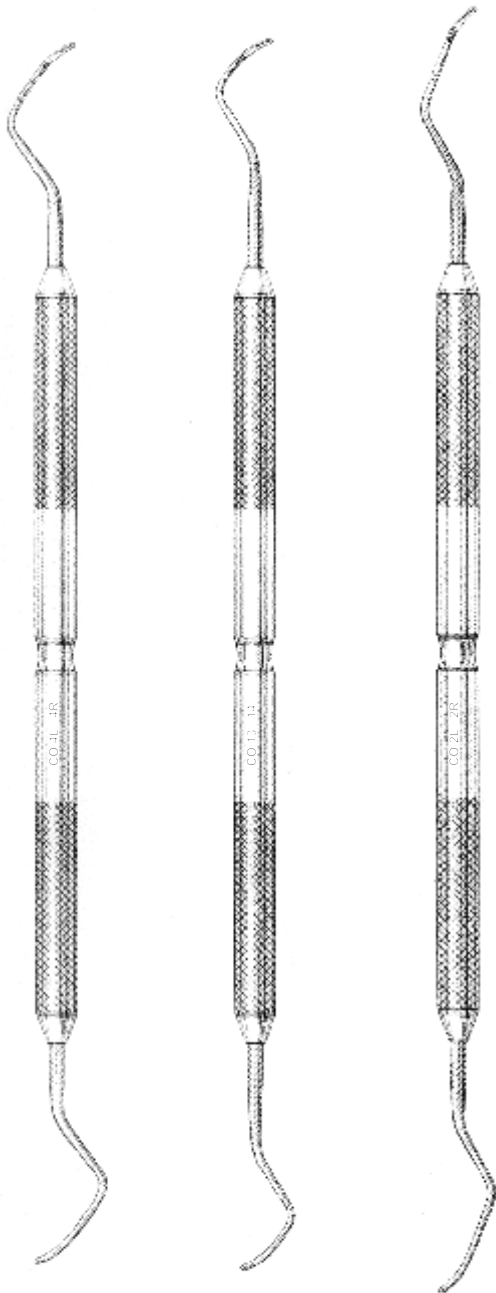

07D-008
4L-4R

07D-009
13-14

07D-010
2L-2R

07D-011
13-14

07D-012
13S-14S

07D-013
17-18

07D-014
17S-18S



07D

GENERAL DENTISTRY INSTRUMENTS

WAX CARVERS





GENERAL DENTISTRY INSTRUMENTS

EXCAVATORS

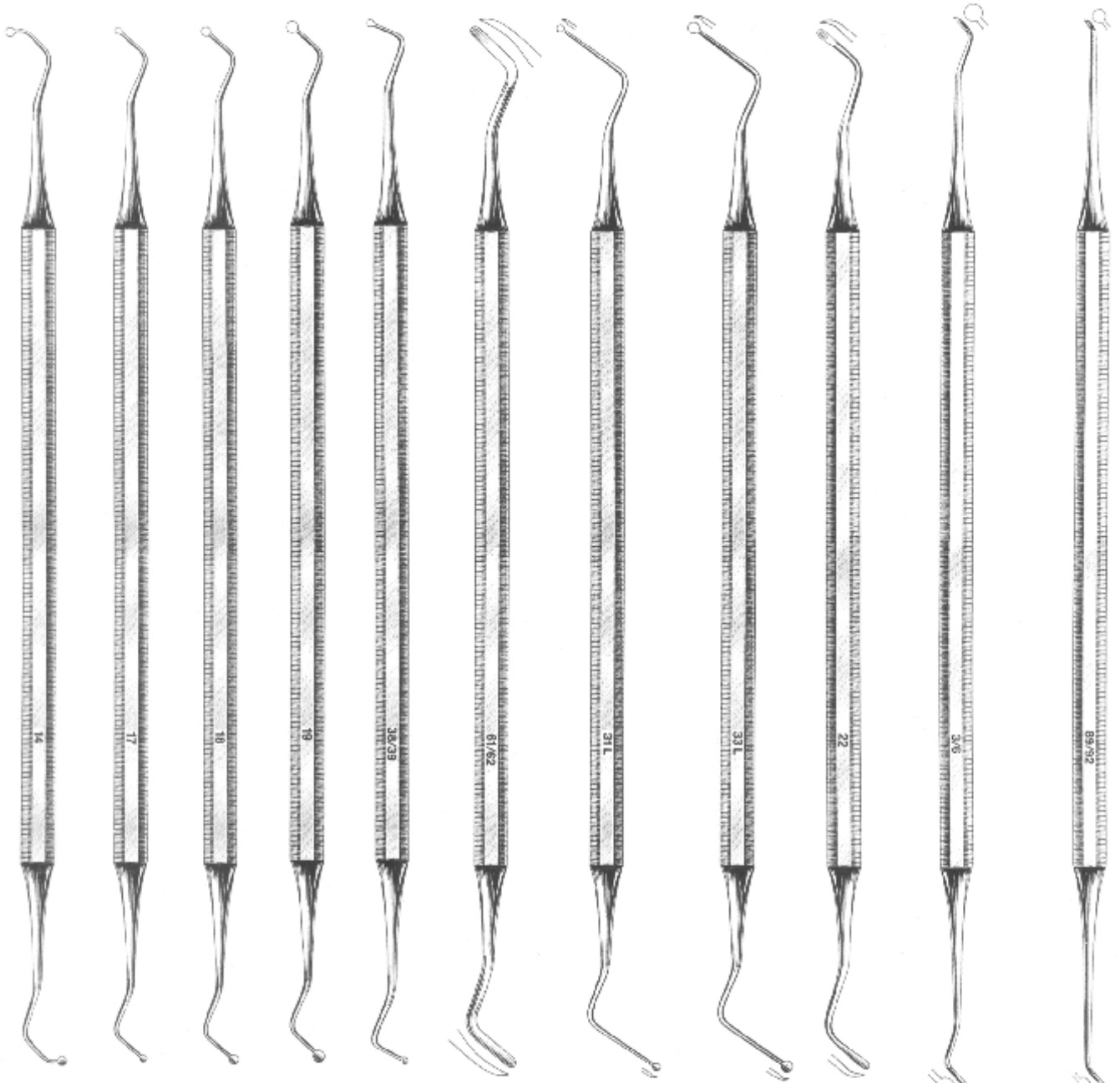

07D-022

07D-023

07D-024

07D-025

07D-026

07D-027

07D-028

07D-029

07D-030

07D-031

Cleoid/Discoid

07D-032

Cleoid/Discoid



GENERAL DENTISTRY INSTRUMENTS

BURNISHERS

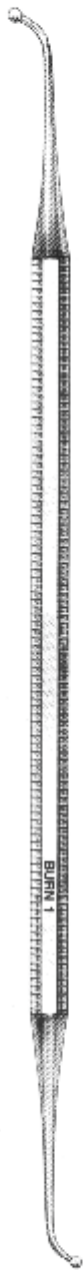

07D-033



07D-034

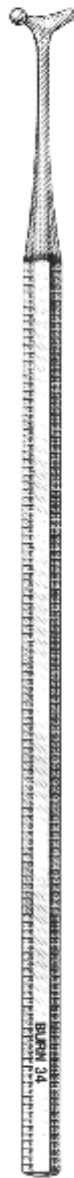

07D-035



07D-036

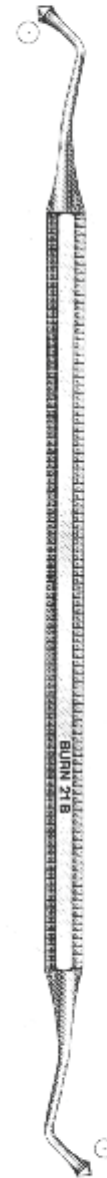

07D-037

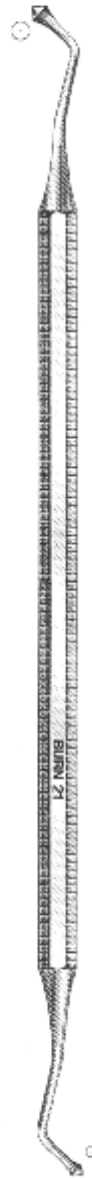

07D-038



07D

GENERAL DENTISTRY INSTRUMENTS

EXPLORERS





07D

PROBES, EXPLORERS, CEMENT SPATULAS

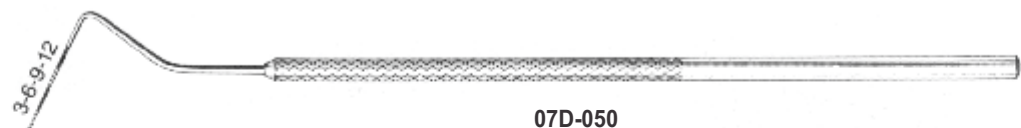

07D-050

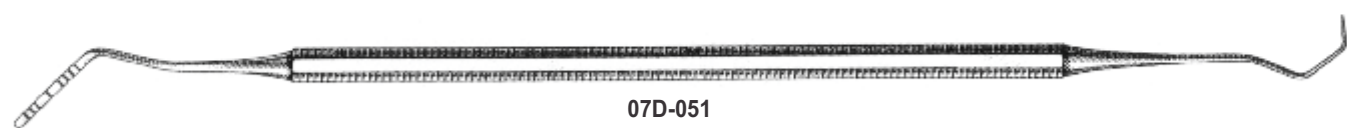

07D-051
Probe/Explorer



07D-052
Probe/Explorer

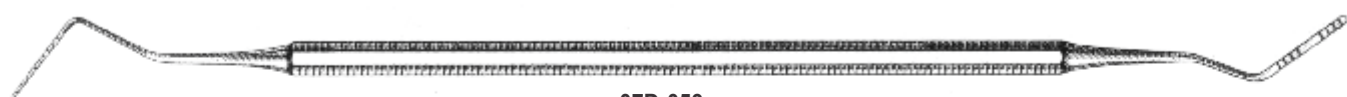

07D-053
Probe



07D-054
C-313



07D-055



07D-056



07D-057



07D

BONE FILES

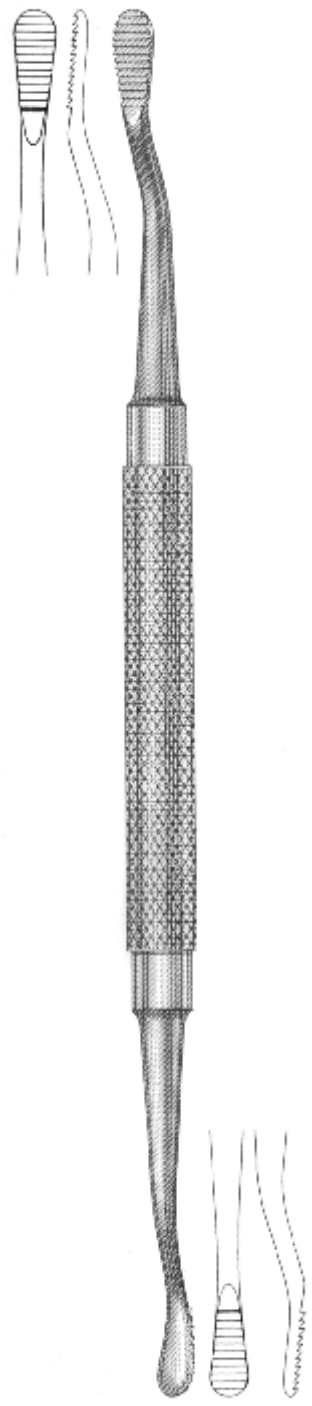

07D-058
Howard

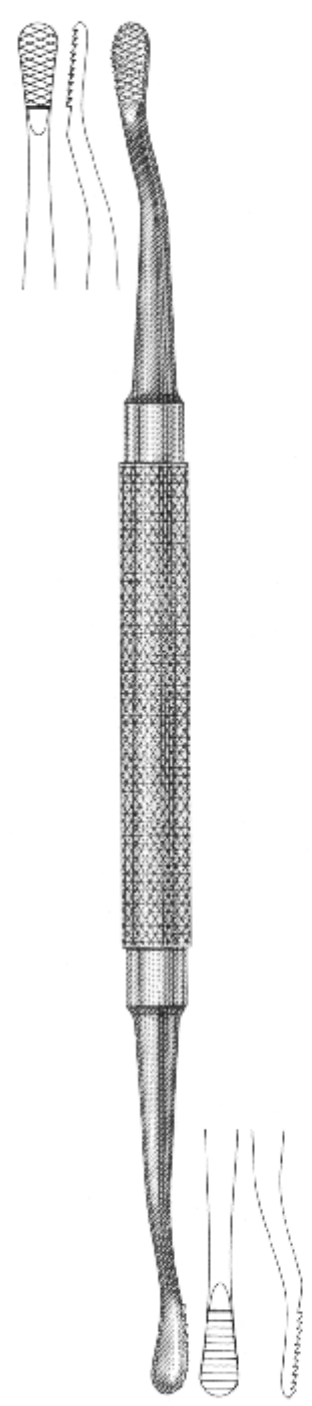

07D-059
Howard

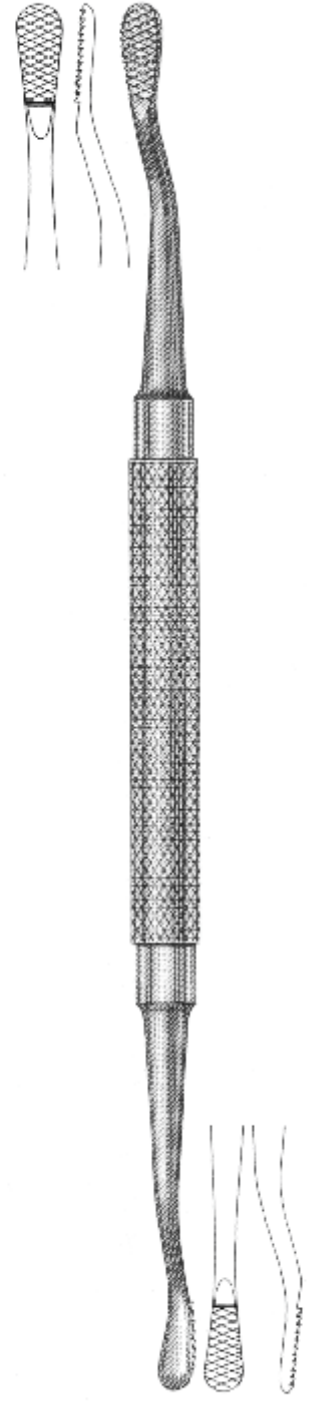

07D-060
Howard

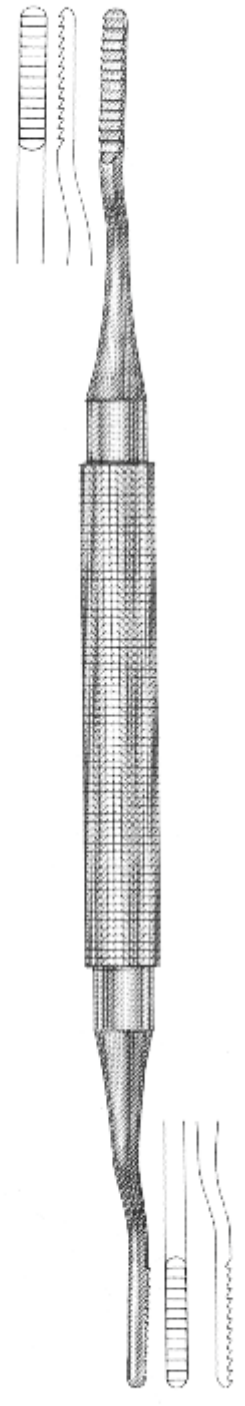

07D-061
Polokoff

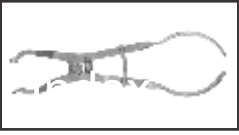

08D

RUBBER DAM FORCEPS & CLAMPS



08D-001
Brewer Rubber Dam Forceps



08D-002
University of
Washington Rubber
Dam Clamp
Forceps



08D-003
IV Type
Rubber Dam Clamp
Forceps



08D-004
IV Type Rubber Dam Punch



08D-005
Ainsworth Rubber Dam Punch



08D-006
Rubber Dam Frame

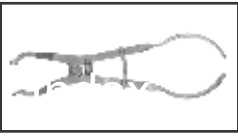

08D

RUBBER DAM FORCEPS & CLAMPS

RUBBER DAM CLAMPS

LOWER MOLARS



08D-007



08D-008



08D-009



08D-010



08D-011



08D-012



08D-013



08D-014

UPPER MOLARS



08D-015



08D-016



08D-017



08D-018



08D-019



08D-020



08D-021



08D-022

PRE MOLARS

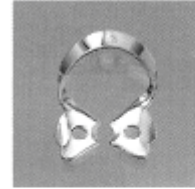

08D-023



08D-024



08D-025



08D-026



08D-027



08D-028

ANTERIOR



08D-040



08D-041

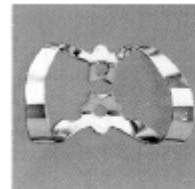

08D-042

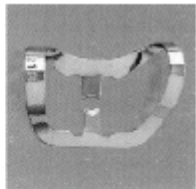

08D-043

MOLARS



08D-029



08D-030



08D-031



08D-032

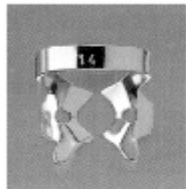

08D-033



08D-034



08D-035



08D-036



08D-037



08D-038



08D-039

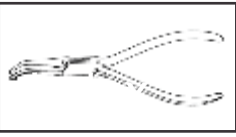

09D

PLIERS



09D-001
Pesso
5½" (14 cm)

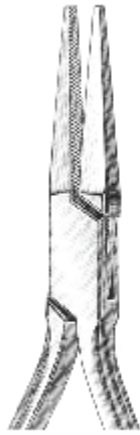

09D-002
Lab and Office



09D-003
Round Nose Plier
5½" (14 cm)



09D-004
Langenbeck
Round Nose Plier
5½" (14 cm)

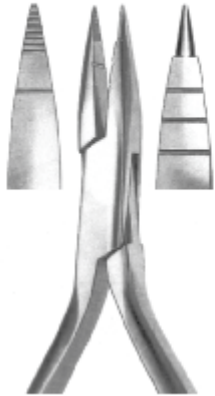

09D-005
Also Suitable for
Jaraback Technic 5½"
(14 cm)



09D-006
5 ⅛" (13 cm)



09D-007 Angle
for wire up to 0.7 mm
diam 5" (12,5 cm)



09D-008 Adams
5" (12,5 cm)



09D-009
Frevert
5" (12,5 cm)

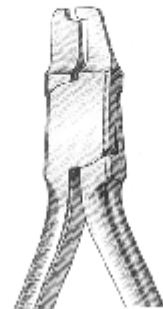

09D-010
417-Crown and Shell

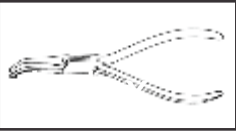

09D

PLIERS



09D-011
Wire Bending



09D-012
How Crown, Straight



09D-013
How Crown, Weingart, Utility



09D-014
Johnson, Contouring



09D-017
Clasp Adjusting

09D-018
Carbide Tipped Ligature Cutter



09D-019
Universal Plier



09D-020
for wire up to 1.0 mm diam
6 ¼" (16 cm)



09D-021
Angle Plier
5 ½" (13 cm)



09D-022
Angle Plier
5 ½" (13 cm)



09D-023
Parallel Action Wire Cutter



10D

IMPRESSION TRAYS



NON PERFORATED

UPPER

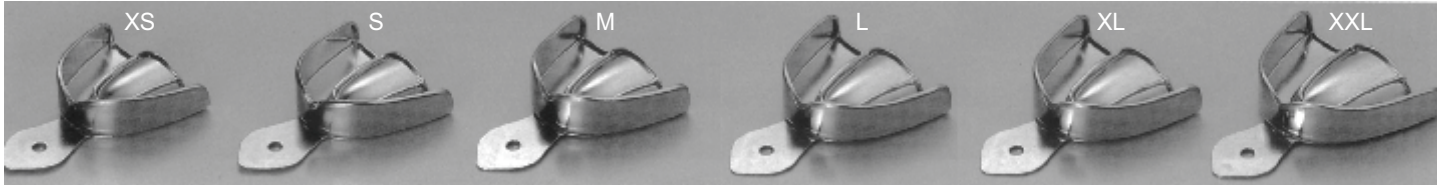

10D-001

10D-002

10D-003

10D-004

10D-005

10D-006

LOWER

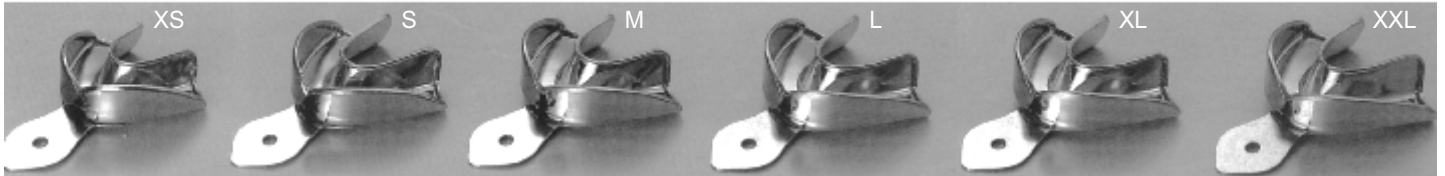

10D-007

10D-008

10D-009

10D-010

10D-011

10D-012



10D-013
Set of 6pcs

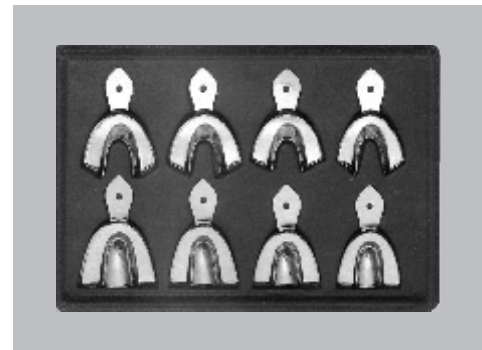

10D-014
Set of 8pcs

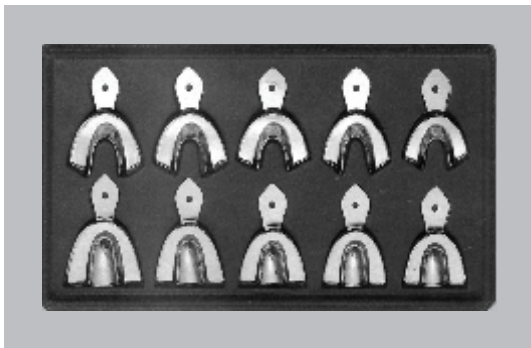

10D-015
Set of 10pcs

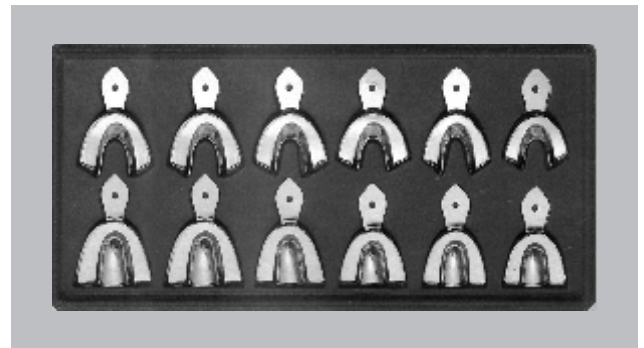

10D-016
Set of 12pcs



10D

IMPRESSION TRAYS

PERFORATED

UPPER

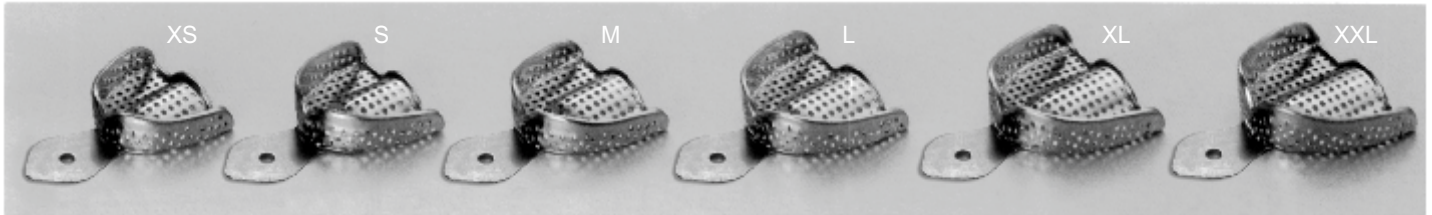

10D-017

10D-018

10D-019

10D-020

10D-021

10D-022

LOWER

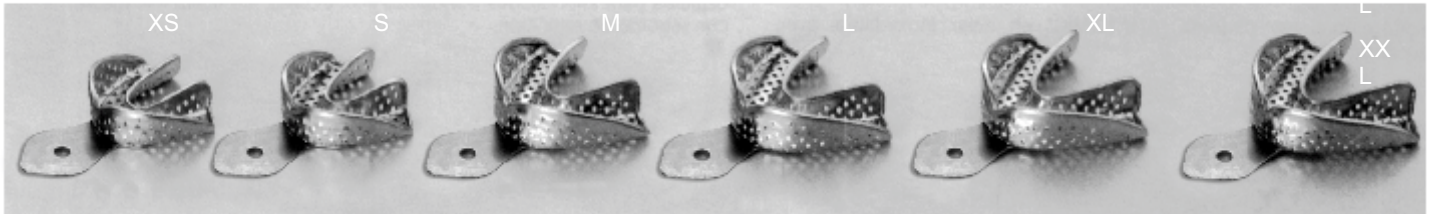

10D-023

10D-024

10D-025

10D-026

10D-027

10D-028

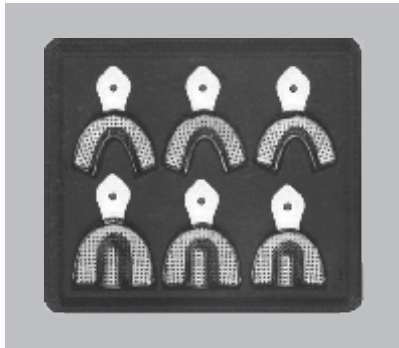

10D-029
Set of 6pcs

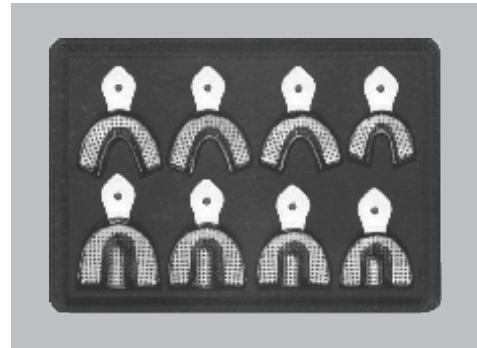

10D-030
Set of 8pcs

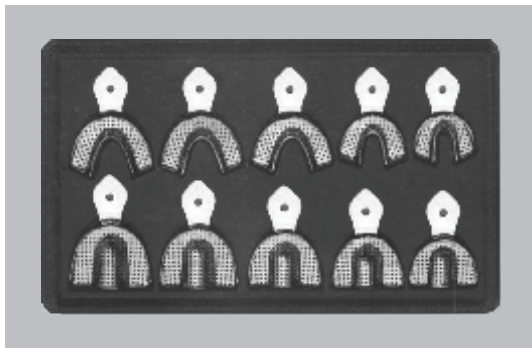

10D-031
Set of 10pcs

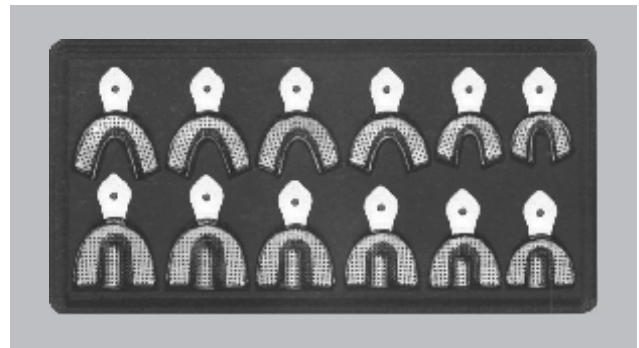

10D-032
Set of 12pcs



E.M.S

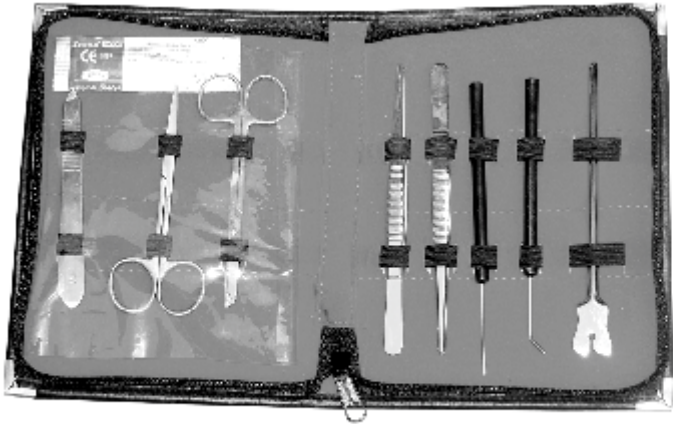

01E-001
Dissecting Set

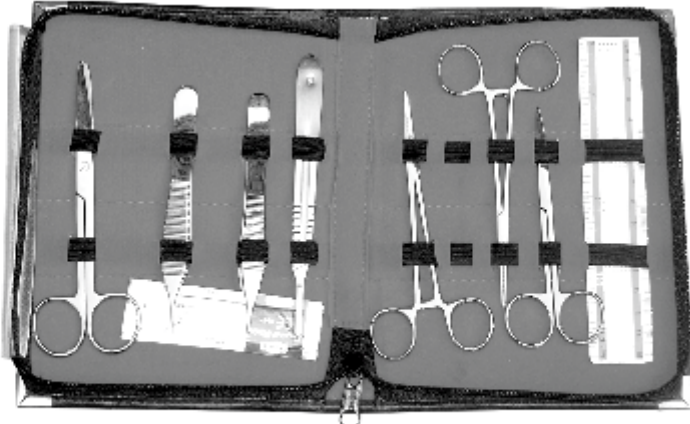

01E-002
Dissecting Set

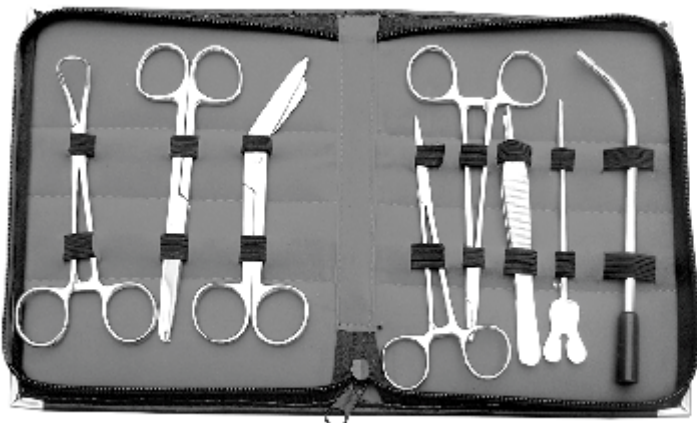

01E-003
Advance Anatomy Dissecting Set



01E-004
Professional Anatomy Dissecting Set

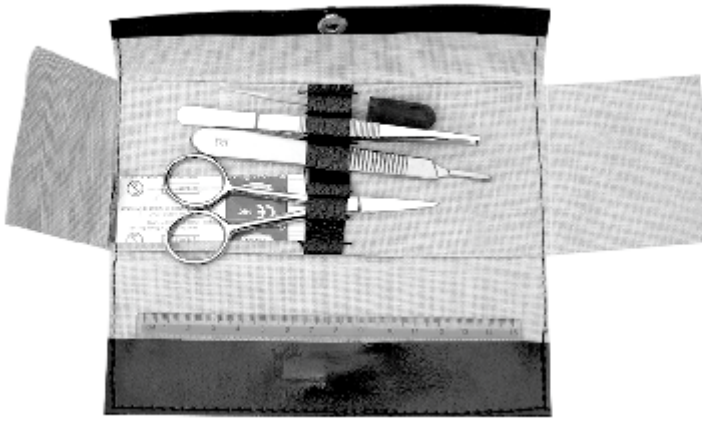

01E-005
Comparative Anatomy Set

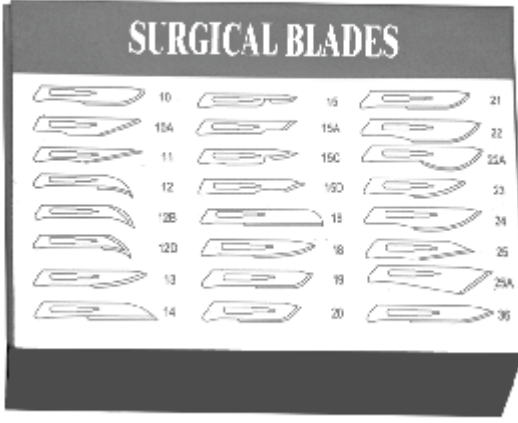

01E-006
Surgical Blade Box of 100 Pcs
Available # 10, 11, 12, 13, 14, 20,
21, 22, 23, 24



01E

E.M.S



Macintosh Laryngoscope Set

01E-007	3 Blade + 1 Handle
01E-008	4 Blade + 1 Handle
01E-009	5 Blade + 1 Handle



Macintosh Fiber Optical Laryngoscope Set

01E-010	3 Blade + 1 Handle
01E-011	4 Blade + 1 Handle
01E-012	5 Blade + 1 Handle



Miller Laryngoscope Set

01E-013	3 Blade + 1 Handle
01E-014	4 Blade + 1 Handle
01E-015	5 Blade + 1 Handle



Miller Fiber Optical Laryngoscope Set

01E-016	3 Blade + 1 Handle
01E-017	4 Blade + 1 Handle
01E-018	5 Blade + 1 Handle



01E-019
Diagnostic Set

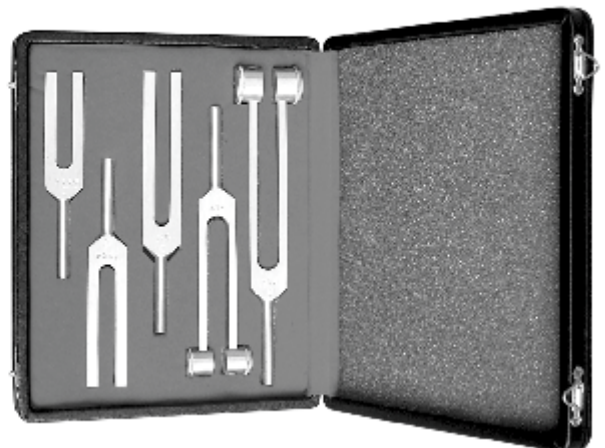

01E-020
Tuning Fork Set
Consist:- C128, C256, C512,
C1024, C2048



01E

E.M.S



01E-021
Sterile Scalpel Handle + Blade (Disposable)



Utility Scissors

01E-022	7¼"
01E-023	5½"

Note: Mention Color Name After Article #



01E-024
Lister Bandage Scissors 5½" with Plastic Ring

Note: Mention Color Name After Article #



01E-025
Lister Bandage Scissors 5½" with Clip

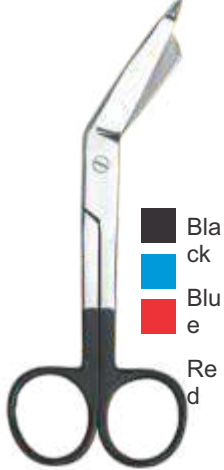

01E-026
Lister Bandage Scissors 5½"

Note: Mention Color Name After Article #

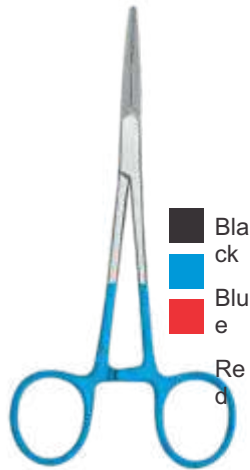

01E-027
Kelly Forceps 5½"

Note: Mention Color Name After Article #

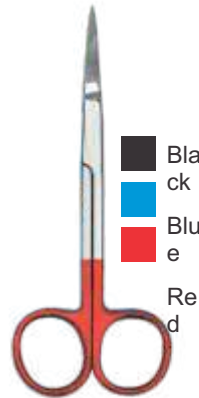

01E-028
Iris Scissors 4½"

Note: Mention Color Name After Article #

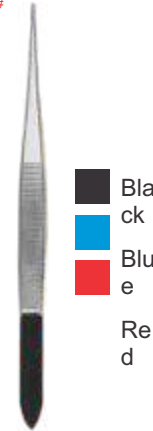

01E-029
Splinter Forceps 4½"

Note: Mention Color Name After Article #



01E-030
Lister Bandage Scissors 3½" Full Gold



01E-031
Rabiner Hammer



01E-032
Taylor Hammer



01E-033
Buck Hammer



01E-034
Pin Wheel



01E-036
Ring Cutter



01E-035
Ring Cutter Spare Blade

01E-037



01E-038
Young Tongue Forceps



Magil Forceps

01E-039	6"
01E-040	8"
01E-041	10"
01E-042	11"



01E

E.M.S



01E-043
Sterile Disposable Syringe Box of 100 Pcs



01E-044
Pen Light with Pupil Gauge Set of 6 Pcs



01E-045
Thermometer Digital



01E-046
Thermometer Dual Mercury Scale



01E-047
Window Puncher



01E-049
Sterile Latex Gloves Box of 12 Pcs



01E-048
Stethoscopes



Glass Jar with Lid

01E-050	3 x 3
01E-051	7 x 4
01E-052	7 x 3
01E-053	6 x 6
01E-054	5 x 5
01E-055	4 x 4



01E-056
Mayo Post Stand (Single Post)



01E-057
Mayo Post Stand (Double Post)

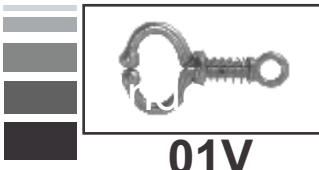

01V

VETERINARY INSTRUMENTS

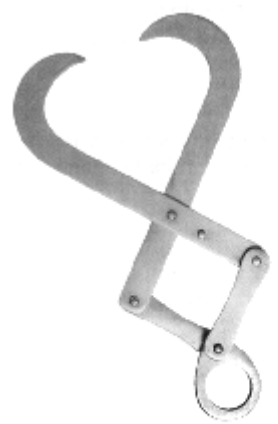

01V-001
Krey
Schottler
XL



01V-002
Harms OB
Hook



01V-003
Ruggebergs
Spring Type
OB Double
Eye Hook



01V-004
Vienna Double Blunt
Eye Hook 14 cm

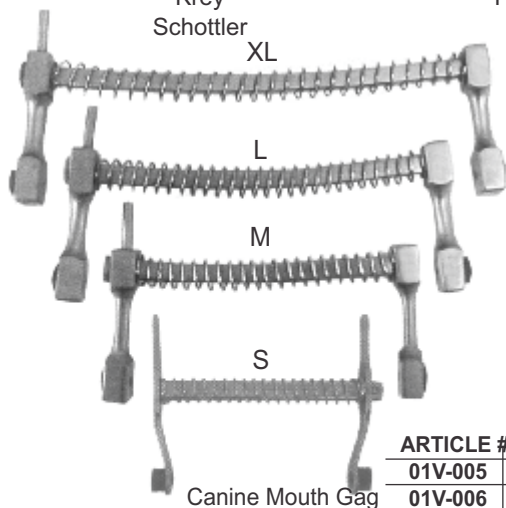

Canine Mouth Gag

ARTICLE #	SIZE
01V-005	S
01V-006	M
01V-007	L
01V-008	XL

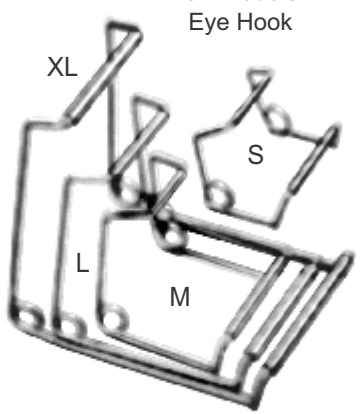

Smith Baxter Mouth Gag

ARTICLE #	SIZE
01V-009	S
01V-010	M
01V-011	L
01V-012	XL



01V-013
Hoof Knife, Left



01V-014
Hoof Knife, Right

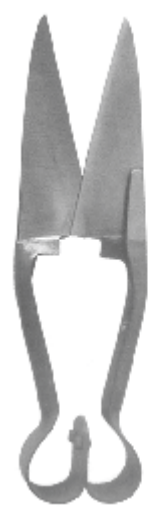

01V-015
Sheep Trimming
Shears



01V-016
White's Tonsil
Scissors 4"



01V-017
Molar
Cutter



01V-018
Molar Extraction
Forceps



01V-019
Sheep Balling Gun
31,5 cm



01V-020
Drench
Pump



VETERINARY INSTRUMENTS

01V



01V-021
Bull Leap (Spring Loaded) 11 cm

01V-030
Hauptner Hoof Tester 14 1/2"



01V-022
Bull Lead



01V-031
Standard Hoof Tester 13"

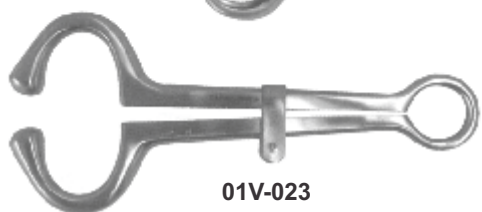

01V-023
Harm's Style Bull Lead 18 cm



01V-032
Adjustable Hoof Tester

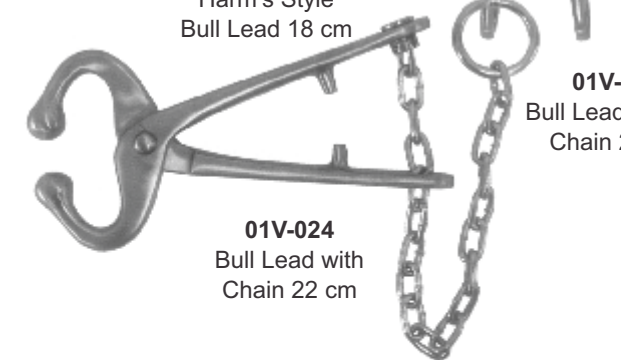

01V-025
Bull Lead without Chain 22 cm



01V-033
Large Hoof Tester 13"

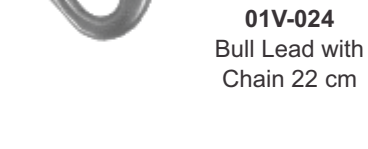

01V-024
Bull Lead with Chain 22 cm



01V-034
Steel Hoof Trimmer

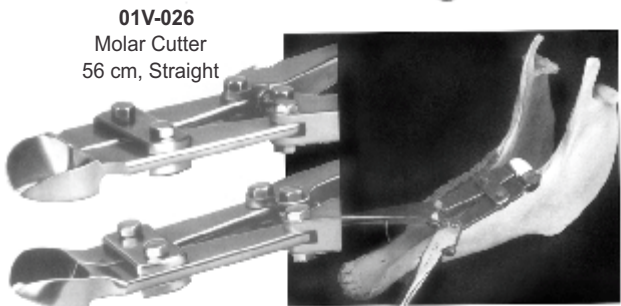

01V-026
Molar Cutter 56 cm, Straight

01V-035
Hoof Trimmer 20"

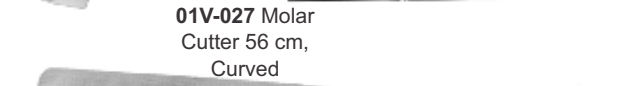

01V-027
Molar Cutter 56 cm, Curved

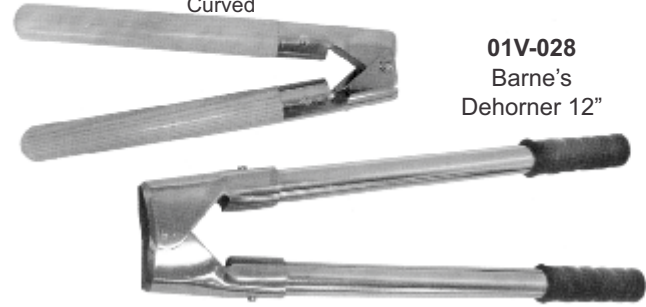

01V-028
Barne's Dehorner 12"



01V-036
Ryding Hoof Tester

01V-029
Dehorner Heavy Duty 17"



01V

VETERINARY INSTRUMENTS

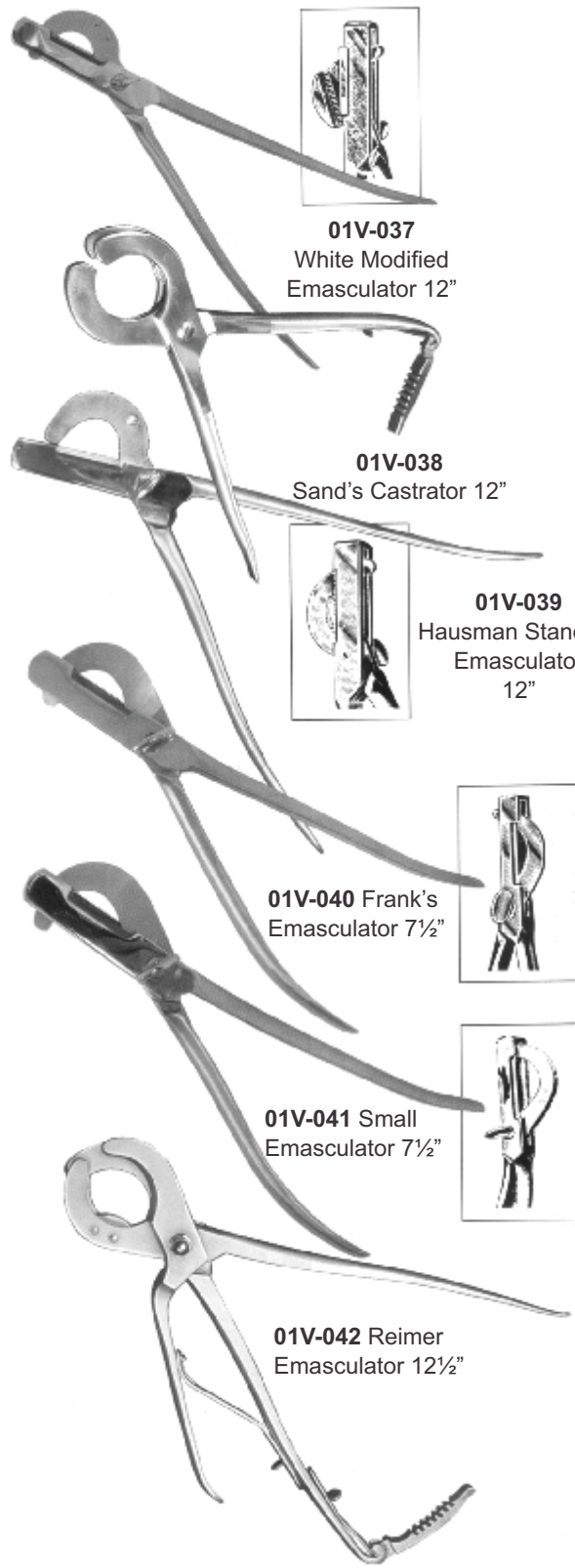

01V-037
White Modified
Emasculator 12"

01V-038
Sand's Castrator 12"



01V-039
Hausman Standard
Emasculator
12"



01V-040 Frank's
Emasculator 7½"



01V-041 Small
Emasculator 7½"

01V-042 Reimer
Emasculator 12½"

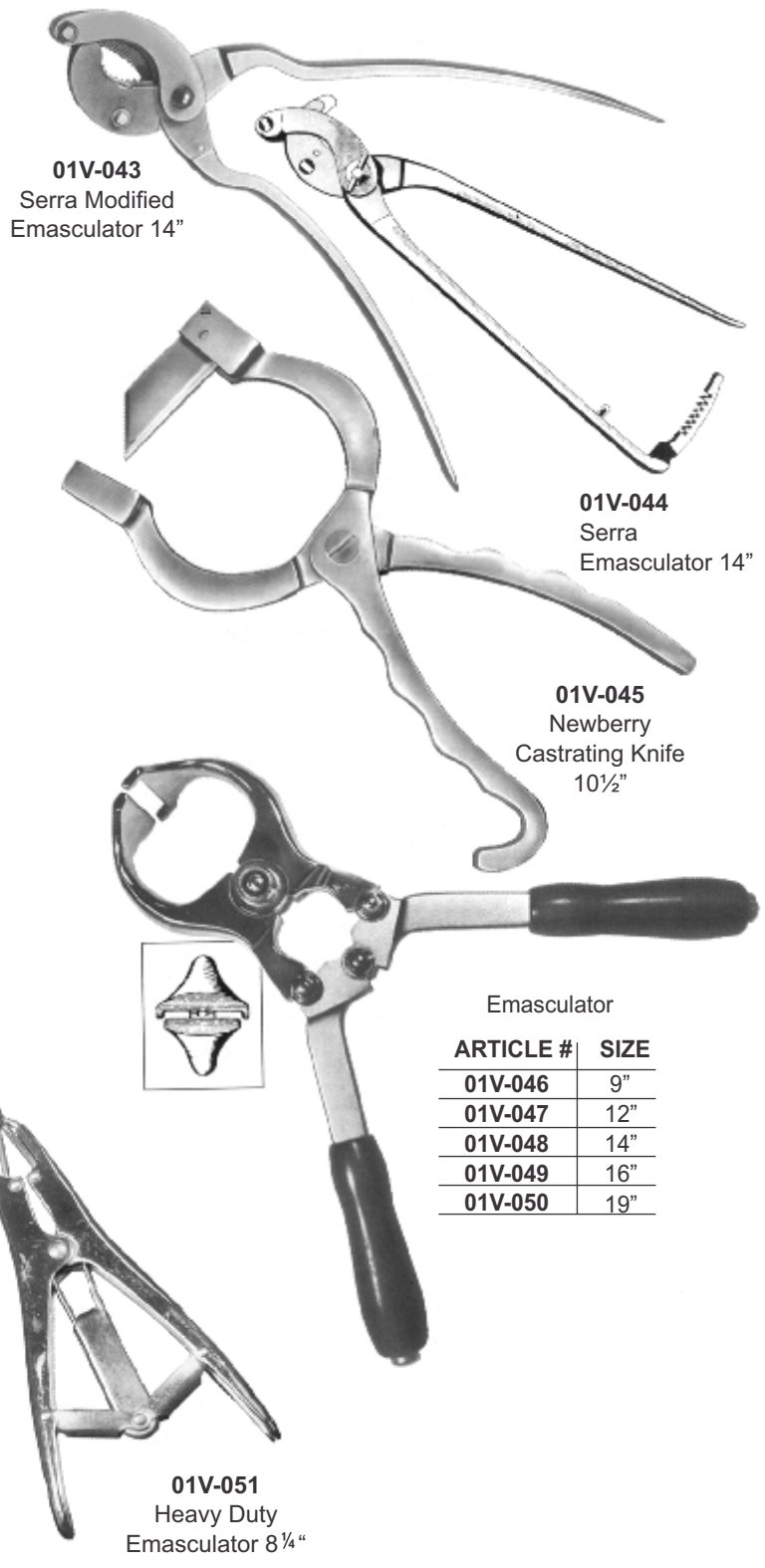

01V-043
Serra Modified
Emasculator 14"

01V-044
Serra
Emasculator 14"

01V-045
Newberry
Castrating Knife
10½"



01V-051
Heavy Duty
Emasculator 8¼"

Emasculator

ARTICLE #	SIZE
01V-046	9"
01V-047	12"
01V-048	14"
01V-049	16"
01V-050	19"



DIAGNOSTIC INSTRUMENTS



Mini Fiber Optic /
Conventional Otoscope
A

Diagnostic Set

Tongue Depressor Holders
A

Clip Lamp Illuminator
A

Mini Ophthalmoscope

INDEX

A		Page	D		Page
ADAM PLIER		138	DAHLGREN INSTRUMENTS		55
ADJUSTABLE HOOF TESTER		147	DANDY HEMOSTATIC FORCEPS		6
ADSON BROW FORCEPS T.C		101	DAVIS BOYLE MOUTH GAG		37
ADSON BROWN FORCEPS		18	DE VIBISS INSTRUMENTS		55
ADSON FORCEPS		18	DE-BAKEY DRESSING FORCEPS DE-		95
ADSON FORCEPS MICRO T.C		101	BAKEY FORCEPS		95, 96
ADSON FORCEPS LASER		111	DE-BAKEY SCISSORS		17
ADSON FORCEPS T.C		101	DE-BAKEY VASCULA DILATOR		76
ADSON HEMOSTATIC FORCEPS		6	DEJERINE PERCUSSION HAMMER		2
ADSON NEEDLE HOLDER		24	DELEE RETRACTOR		31
ALCOHAL LAMP		112	DENHARDT MOUTH GAG		36
ALLIS TISSUE FORCEPS		10	DENIS BROWN ABDOMINA RETRACTOR		34
ALLIS TISSUE FORCEPS LASER		111	DERF NEEDLE HOLDER		23
ALM RETRACTOR		32	DESMARRESS CHALLAZION FORCEPS		88
AMALGAM CARRIER		123	DESMARRESS LID RETRACTOR		85
AMALGAM CARRIER SWISS PATTERN		123	DESMARRESS RETRACTOR		27
ANATOMY DISSECTING SET ADVANCE		142	DEVER RETRACTOR		28
ANATOMY DISSECTING SET PROFESSIONAL		142	DIAGNOSTIC SET		142
ANGLE PLIER		138	DIAMANT WIRE CUTTING PLIER		73
ANGLE PLIER T.C		139	DILATOR'S		76
ARRUGA NEEDLE HOLDER		94	DINGMANN BONE FORCEPS		63
ARTERY FORCEPS SPENCERWELL		7	DISPOSABLE SYRINGE STERILE		145
ARTICULATING PAPER FORCEPS		126	DISSECTING SET		142
ASPIRATION SYRING		124	DITTEL SOUND		76
AUFRICHT CURETTE		50	DOYEN ABDOMINAL SCISSORS		17
AUVARD VAGINAL SPECULUM		77	DOYEN BIOPSY FORCEPS		81
AYER CHALAZION FORCEPS		8	DOYEN HAMMER		62
B			DOYEN VAGINAL SPECULA		78
BABCOCK FORCEPS		10	DRENCH PUMP		146
BABY MIXTER ARTERY FORCEPS		8	DRESSING FORCEPS		19
BACKHAUS TOWEL CLAMP		12	DRESSING FORCEPS T.C		102
BACKHAUS TOWEL CLAMP LASER		110	DRESSING SCISSORS T.C		97
BAILEY RIB CONTRACTORS		54	DURANTE TISSUE FORCEPS		21
BALFOUR CENTER		33	DUVAL TISSUE FORCEPS		21
BLADE BALFOUR RETRACTOR		33	E		
BALL & SOCKET TOWEL CLAMP		12	EXTRACTING FORCEPS		115 TO 117
BALL CHAIN		125	EANGLE CAST SAW		67
BALLENGER SPETUM KNIVES		48	EAR FORCEPS		41 TO 46
BALLING GUN		146	EAR SPECULUM		40
BANDAGE SCISSORS		16	EAR SYRINGE		40
BANGOLEA HEMOSTATIC FORCEPS		9	ECHLIN BONE RONGUER		69
BARRAQUER EYE SPECULUM		86	ELASTRATOR		148
BARRAQUER NEEDOLE HOLDER		93	ELDCHING FIXATION FORCEPS		89
BARRAQUER SCISSORS		90	ELEVATORS		118 TO 121
BARRETT TENACULUM FORCEPS		74	EMASCULATOR		133
BARRON SUCTION TUBE		49	EMISES BASIN		114
BARTH EAR CURETTE		45	EPPENDORF BIOPSY FORCEPS		81
BASIN EMISES		114	ERHARDT CHALAZION FORCEPS		88
BAUMGARTNER NEEDLE HOLDER		23	EVANS TISSUE FORCEPS		103
BAYONET FORCEPS T.C		101	EXCAVATORS		130
BECKMANN NASAL SPECULUM		38	EXPLORER		132
BEDPAN AMERICAN TYPE		114	F		
BEDPAN SLIPER TYPE		114	FARABEUF BONE HOLDING FORCEPS		66
BELLUCCI MICRO EAR FORCEPS		42	FARABEUF LAMBOTTE BONE HOLDING		66
BILLEAU EAR FORCEPS		45	FORCEPS FARABEUF RETRACTOR		27
BIRCHER GANSKE FORCEPS BISHOP		63	FERGUSSON BONE HOLDING FORCEPS		64
HARTMAN FORCEPS BLADE BREAKER		88	FERRIS SMITH KERISION RONGUER		57
BLADES B.P HANDLE		94	FINOCHIETOO RIB SPREADERS		53
BLUEMENTHAL BONE RONGUER		142	FISCH EAR INSTRUMENTS		46
BOLEY GUAGE		68	FLAT NOSE PLIER		72, 73
BOLT CUTTER		126	FOERSTER SPONG FORCEPS		11
BONE & RIB SHEARS		72	FORCEPS JAR		112
BONE CHISEL		50	FRAZIER DURA HOOK		26
BONE CUTTER T.C		61, 135	FRAZIER SUCTION TUBE		49
BONE FILE		107	FRENCH LAMINECTOMY SPREADERS		54
BONE GOUGE		134	FREVERT PLIER		138
BONE HAND DRILL		61	FRITSCH RETRACTOR		31
BONE HOLDING FORCEPS		58	FROSCH BONE HOLDING FORCEPS		64
BONE RONGUERS		63, 64			
BONNEY TISSUE FORCEPS		68, 69			
BONNEY TISSUE FORCEPS T.C		21			
C					
CAMPION LASER FORCEPS		109			
CANINE MOUTH GAG		146			
CARHALT SPLINTER FORCEPS		22			
CARMALT FORCEPS		7			
CASPER RETRACTOR FOR SPINE		54			
CAST SPREADER 3PRONG		67			
CASTROVIEJO BLADE BREAKER		94			
CASTROVIEJO CALIPER		86			
CASTROVIEJO CORNEAL SCISSORS		91			
CASTROVIEJO FIXATION FORCEPS		89			
CASTROVIEJO KALT NEEDLE HOLDER		94			
CASTROVIEJO NEEDLE HOLDER		92			
CASTROVIEJO SCISSORS		90			
CASTROVIEJO SPATULA		85			
CATHITER TRAY		112			
CATRIDGE SYRING		124			
CEMENT SPATULA		133			
CHARRIERE RESECTION SAW		59			
CHARRIERE SAW		59			
CLASP ADJUSTING PLIER		139			
CLEVELAND BONE CUTTING FORCEPS		71			
CLIP APPLYING FORCEPS		56			
CLOWARD LAMINA SPREADERS		55			
COLIBRI FORCEPS		87			
COLLEGE TWEEZER		126			
COLLIER NEEDLE HOLDER		23			
COLLIN ABDOMINAL RETRACTOR		33			
COLLIN CLAMP		83			
COLLIN DUVAL GRASPING FORCEPS		21			
COLLIN HAMMER		62			
COLLIN VAGINAL SPECULUM		77			
COLLIN TONGUE FORCEPS		35			
COLOUMBIA RETRACTOR		36			
COLUMBIA CURETTE		128			
CONE RETRACTOR		32			
COOLEY RIB SPREADERS		53			
COTTLE CURETTE		50			
COTTON WOOL CONTAINER		113			
COTTON WOOL DISPENCER		112			
CRILE HEMOSTATIC FORCEPS		5			
CRILE MURRAY NEEDLE HOLDER		24			
CRILE NEEDLE HOLDER		25			
CRILE RANKIN HEMOSTATIC FORCEPS		5			
CRILE WOOD NEEDLE HOLDER		24			
CROWN & SHELL REMOVING PLIER		138			
CROWN GUAGE		125			
CRUSH EMASCULATOR		148			
CRUTCHFIELD TRACTION		55			
CUSHING DRESSING / TISSUE FORCEPS		20			
CUSHING DRESSING FORCEPS T.C		102			
CUSHING LAMINECTOMY RONGUERS		57			
CUSSCO VAGINAL SPECULUM		77			
CUZZI SPOON		84			

INDEX

G	Page	I			
GAYLOR UTERINE BIOPSY FORCEPS	80	IRIS SCISSORS	16, 87	LASER CUSCO VAGINAL SPECULUM	108
GELLBORN UTERINE BIOPSY FORCEPS	80	INSTRUMENTS BOX	113	LASER GRAVES VAGINAL SPECULUM	108
GELPI RETRACTOR	32	INSTRUMENTS TRAY	112	LASER LATERAL VAGINAL SPECULUM	108
GEMINI HEMOSTATIC FORCEPS	9	IRIS SCISSORS COLOUR	144	LASER PEDRESON VAGINAL SPECULUM	108
GERALD DRESSING FORCEPS T.C.	103	IRIS SCISSORS T.C.	100	LAWRANCE GUAGE	126
GEROG MALLETT HAMMER GIERTZ-	62	IMPRESSION TRAY	140, 141	LEBSCHKE STERNUM SCISSORS	52
STILLE STERNUM SCISSORS GIGLI	52			LEEF LATERAL VAGINAL RETRACTOR	79
SAW HANDLE	59	J		LERCHE TISSUE FORCEPS	21
GIGLI SAW WIRE	59	JACKSON RETRACTOR LASER	110	LERICHE HEMOSTATIC FORCEPS	6
GILLIES DRESSING FORCEPS	20	JACKSON TRACHETOMY TUBE	48	LESTER FIXATION FORCEPS	89
GILLIES NEEDLE HOLDER	24	JACOBS TENACULUM FORCEPS	75	LEWIN BONE HOLDING FORCEPS	63
GILLIES TISSUE FORCEPS T.C.	103	JACOBSON NEEDLE HOLDER	92	LEXER BABY SCISSORS	16
GLASS JAR GLOVES	145	JAEGER LID PLATE	86	LICHTENBERG NEEDLE HOLDER	25
GLUCK BONE & RIB SHEARES	145	JAMESON MUSCLE HOOK	85	LIEBERMAN EYE SPECULUM	86
GOODEL UTERINE DILATOR	52	JANSEN BONE RONGUER	68	LIGATURE STITCH SCISSORS	16
GOSSET RETRACTOR	79	JANSEN EAR CURETTE	45	LIGATURE CUTTER	139
GRACEY CURETTE	33	JAR	113	LISTER BANDAGE SCISSORS	16
GRAEFE FIXATION FORCEPS	127	JENING MOUTH GAG	36	LISTER BANDAGE SCISSORS COLOUR	144
GRAEFE HOOK	89	JEWELLER FORCEPS	22	LISTER BANDAGE SCISSORS PLASTIC RING	144
GRAEFE IRIS FORCEPS	26	JOHNSON CONTOURING PLIER	139	LISTER BANDAGE SCISSORS WITH CLIP	144
GRAEFE MUSCLE HOOK	87	JONES TOWEL CLAMP	12	LISTON BONE CUTTING FORCEPS	70, 71
GRAVES VAGINAL SPECULUM	85	JOSEPH CURETTE	50	LNGE LAMINA SPREADERS	55
GREEN ARMTAGE FORCEPS	77	JOSEPH PERIOSTEAL ELEVATOR	48	LORNA TOWEL CLAMP	12
GRIP PLIER	83	JOSEPH SCISSORS	26	LOWMANN BONE HOLDING FORCEPS	65
GROSS MAIER DRESSING FORCEPS	72	JUDD ALLIS TISSUE FORCEPS	10	LUCAE EAR FORCEPS	45
GRUBER EAR SPECULUM	11			LUCAE HAMMER	62
GUTHRIE SKIN HOOK	40	K		LUCAE TUNING FORK	51
	26	KALT ARRUGA NEEDLE HOLDER	94	LUCAS ELEVATOR	121
		KANE CLAMP	83	LUER BONE RONGUER	68
H		KANSAS LENS LOOP	85	LUER TRACHETOMY TUBE	48
HALSEY NEEDLE HOLDER	23	KELLY FORCEPS COLOUR	144	LWEIFE CURETTE	50
HALSTED MOSQUITO FORCEPS	4	KELLY HEMOSTATIC FORCEPS	5	M	
HANK DILATOR	76	KELLY RANKIN HEMOSTATIC FORCEPS	5	MAGIL FORCEPS	35, 144
HARMS STYLE BULL LEAD	147	KELLY RETRACTOR	31	MAIER DRESSING FORCEPS	11
HARTMAN MOSQUITO FORCEPS	4	KELLY SCISSORS	17	MALTZ CURETTE	50
HARTMAN BABY MOSQUITO FORCEPS	4	KERN BONE HOLDING FORCEPS	66	MARKHAM MEYERDING RETRACTOR	32
HARTMAN BONE RONGUER	68	KERRISION RONGUER	57	MARKWALDER BONE CUTTING FORCEPS	70
HARTMAN EAR POLYPUS FORCEPS	44	KERY HOOK	146	MARTIN BONE FORCEPS	63
HARTMAN EAR SPECULUM	40	KEVORKIAN BIOPSY FORCEPS	81	MARTIN PELVIMETER	84
HARTMAN HALLE NASAL SPECULUM	38	KIDNEY TRAY	112	MATHEW NEEDLE HOLDER	25
HARTMAN NASAL SPECULUM	49	KIELLAND OBSTETRICAL FORCEPS	84	MAYO HEGAR NEEDLE HOLDER LASER	110
HARTMAN OTOTOLOGY INSTRUMENTS	51	KILLIAN NASAL SPECULUM	39	MAYO HEGAR NEEDLE HOLDER	24
HARTMAN TUNNING FORK	147	KIRBY FORCEPS	88	MAYO POST STAND	145
HAUPTNER HOOF TESTER	3	KIRSCHNER ABDOMINAL RETRACTOR	34	MAYO RUSS TISSUE FORCEPS	21
HEAD LIGHT	3	KOCHER HEMOSTATIC FORCEPS	6	MAYO SCISSORS	14
HEAD MIRROR	7	KOCHER RETRACTOR	20, 30, 31	MAYO SCISSORS STILLE T.C.	97
HEANEY HEMOSTATIC FORCEPS	24	KOGAN ENDOCERVICAL SPECULUM	79	MAYO SCISSORS T.C.	98
HEANEY NEEDLE HOLDER	110	KOGAN LASER FORCEPS	109	MAYO STILLE SCISSORS	14
HEANEY NEEDLE HOLDRE LASER	148	KRATZ BARRAQUER EYE SPECULUM	86	MAYO TRAY	112
HEAVY DUTY ELASTRATOR	76	KRAUSE NASAL SNARES	49	MCCALLS CURETTE	128
HEGAR DILATOR DOUBLE END	76	KRISTELLER VAGINAL SPECULUM	78	MCGEE EAR FORCEPS	42
HEGAR DILATOR SINGLE END	119			MCINDOE FORCEPS	20
HEIDBRINK ROOT TIP PICK ELEVATOR	5	L		MCINDOE FORCEPS T.C.	101
HEMOSTATIC CRILE FORCEPS	6	LABORDE DILATOR	35	McKENZIE CLIP APPLYING FORCEPS	56
HEMOSTATIC CRILE RANKIN FORCEPS	6	LAMBOTTE BONE HOLDIN G FORCEPS	66	McLOVER MOUTH GAG	37
HEMOSTATIC FORCEPS ADSON	6	LAMPERT BONE RONGUER	68	MEARIAM TWEEZER	126
HEMOSTATIC FORCEPS DANDY	6	LAMPERT CURETTE	65	MEISTER MOUTH GAG	36, 37
HEMOSTATIC FORCEPS KOCHER	6	LANE BONE HOLDING FORCEPS	65	METZENBAUM SCISSORS	15
HEMOSTATIC FORCEPS LERICHE	6	LANG WILDE NASAL SNARE	49	METZENBAUM SCISSORS T.C.	99
HEMOSTATIC FORCEPS PROVIDENCE	5	LANGENBACK BONE HOLDING FORCEPS	64	MEYERHOEFER CURETTE	85
HOSPITAL HEMOSTATIC KELLY FORCEPS	67	LANGENBACK PLIER	138	MICRO EAR FORCEPS	41, 42
HEMOSTATIC KELLY RANKIN FORCEPS	12	LANGENBACK SAW	59	MIDDELDRPFF RETRACTOR	31
HENNING SPREADER	146	LARYANGOSCOPE MACINTOSH FIBER	143	MIKULICZ PERITONEAL CLAMP FORCEPS	9
HOFF TOWEL CLAMP	147	LARYANGOSCOPE MACINTOSH REGULAR	143	MILTEX MALLETT	62
HOOF KNIFE	147	LARYANGOSCOPE MILLER FIBER	143	MINI LANGENBACK RETRACTOR	29
HOOF TESTER ADJUSTABLE	47	LARYANGOSCOPE MILLER REGULAR	143	MIRROR DENTAL	122
HOOF TRIMMER	46	LASER AUWARD VAGINAL SPECULUM	108	MIRROR HANDLE	122
HOUSE CURETTE	139	LASER COLLIN VAGINAL SPECULUM	108	MISKIMOM RETRACTOR	32
HOUSE EAR INSTRUMENTS	58			MIXTER ARTERY FORCEPS	7
HOW CROWN PLIER				MIXTER BABY ARTERY FORCEPS	7
HUDSON BONE DRILL				MIXTER OSCHNER ARTERY FORCEPS	8

INDEX

MOD USA DRESSING FORCEPS T.C	103
MODIFIED EMASCULATOR	148
MOLAR CUTTER	50, 146
MOLAR EXTRACTION FORCEPS	146
MOORE HAND DRILL	58
MOORFIELD FIXATION FORCEPS	89
MORSE RETRACTOR	26
MOSQUITO FORCEPS	4
MOSQUITO FORCEPS BABY	4
MOUTH GAG	36
MULI ELEVATOR	121
MUSEUX TENACULUM FORCEPS	74

N

NAEGELE OBSTETRICAL FORCEPS	84
NASAL SPECULUM	38, 39
NEEDLE HOLDER T.C	104
NEEDLE HOLDERS	23 TO 25
NEIVERT NEEDLE HOLDER	23
NEWBERRY CASTRATING KINFE	146
NOSE PLIER	138
NOYES IRIS SCISSORS	90

O

O.SULLIVAN-O CONNOR RETRACTOR	33
OEHLER TISSUE FORCEPS T.C	102
OIMENT JAR	112
OLIVEERONA TOENNIS	56
OLSEN HEGAR NEEDLE HOLDER	24
OPERATING SCISSORS	13
OSTERTAGE EYE HOOK	146

P

PAPER FORCEPS	126
PARALLEL ACTION WIRE CUTTER	139
PARAMETRIUM SCISSORS	17
PATON NEEDLE HOLDER	94
PAUFIQUE SUTURE FORCEPS	89
PEDERSON VAGINAL SPECULUM	77
PEERS TOWEL CLAMP	12
PEN LIGHT	145
PENINGTON FORCEPS	10
PERCUSSION HAMMER	2
PERCY ABDOMINAL RETRACTOR	34
PERIOSTEAL ELEVATOR	120
PESSO PLIER	138
PIN CUTTER	76
PIN WHEEL	144
PINARD STETHOSCOPE	3
POLITZER EAR BAG	40
POLITZER EAR SPECULUM	40
POOTS SMITH DRESSING FORCEPS LASER	111
POOTS SMITH DRESSING FORCEPS T.C	102
POOTS SMITH SCISSORS T.C	100
POTTS ELEVATOR	120
POTTS SMITH DRESSING FORCEPS	20
POZZI TENACULUM FORCEPS	74
PRATT TENACULUM FORCEPS PROBES	75
PROVIDENCE HOSPITAL HEMOSTATIC FORCEPS	3, 133
	6

Q

QUIRE EAR FORCEPS	44
-------------------	----

R

RABINER NEUROLOGICAL HAMMER	2, 144
RAGNELL DAVIS RETRACTOR	26
RAMPLEY SPONG FORCEPS	11
RANEY CLIP APPLAYING FORCEPS	56
REMIER EMASCULATOR RETRACTORS	148
REYNOLDS CONTOURING PLIER	26 TO 34
RIB CONTRACTORS	139
RIB SHEARES	54
RIB SPREADERS	52
RICHARDSON EASTMAN	53
RETRACTOR RING CUTTER	27
RING CUTTER WITH SAFETY CAP	144
ROCHESTER CARMALT FORCEPS	144
ROEDER TOWEL CLAMP	7
ROOT TIP PICK ELEVATOR	12
ROSEN EAR INSTRUMENTS	119
ROSER KORING MOUTH GAG	46
ROUX RETRACTOR	36
ROUX RETRACTOR MINI	27
RUBBER DAM CLAMPS	27
RUBBER DAM CLAMP FORCEPS	137
RUBBER DAM FRAME	136
RUBBER DAM PUNCH	136
RUGGEBERG SPRING TYPE EYE HOOK	146
RUSKIN BONE CUTTING FORCEPS	70
RUSKIN BONE RONGUER	69
RUSKIN LISTON BONE CUTTING FORCEPS	70
RUSS MODELL TISSUE FORCEPS	21
RYDEL SEIFFER TUNING FORK	51
RYDING HOOF TESTER	147

S

SAENGER FORCEPS	
SANDS CASTRATOR	148
SATTERLEE SAW	59
SAUEBRUCH BONE RONGUER	69
SAUERB-RUCH STERNUM SCISSORS	52
SCALPLE BLADES	1
SCALPLE HANDLE	1
SCHAEDEL TOWEL CLAMP	12
SCHUDE BONE CURETTE	60
SCHROEDER TENACULUM FORCEPS	74, 75
SCHROEDER TENACULUM FORCEPS LASER	109
SCHUBERT UTERINE BIOPSY FORCEPS	80
SCHUKNECHT EAR INSTRUMENTS	46
SCHWEIZER FORCEPS LASER	109
SCISSORS	13 TO 17
SELLHEIN FORCEPS	71
SEMB BONE CUTTING FORCEPS	66
SEMB BONE HOLDING FORCEPS	69
SEMB BONE RONGUER	26
SENN MULLER RETRACTOR	148
SERRA MODIFIED EMASCULATOR	45
SHAPLEIGHY EAR CURETTE	47
SHEA CURETTE	146
SHEEP TRIMMING SHEARES	84
SIMPSON BRAUN OPSTETRICAL FORCEPS	84
SIMPSON OPSTETRICAL FORCEPS	84
SIMS UTERINE CURETTE	79
SIMS UTERINE SOUND	79
SIMS VAGINAL SPECULUM	77
SINGLEY FORCEPS LASER	111
SKINNER TISSUE FORCEPS T.C	102
SMITH BAXTER MOUTH GAG	146
SNARES	49
SNELLEN EAR FORCEPS	45
SPENCERWELL ARTERY FORCEPS	7
SPLINTER FORCEPS	18
SPLINTER FORCEPS COLOUR	144
SPONG FORCEPS	11
SPRATT BONE CURETTE	60

STANDARD HOOF TESTER	147
STERILE SCALPLE HANDLE+BLADE	144
STERILIZING CONTAINER	114
STERILIZING DRUM	114
STERILIZING TRAY STETHOSCOPES	112
STEVEN NEEDLE HOLDER	145
STEVEN SCISSORS	94
STEVENSON LACRIMAL SAC	16
RETRACTOR STILLE BONE CHISELS	86
STILLE BONE GOUGE	61
STILLE CAST SHEARES	61
STILLE LISTON BONE CUTTING	67
FORCEPS STILLE RUSKIN BONE	71
RONGUER	69
STITCH SCISSORS	16
STONE TISSUE FORCEPS	21
STRABISMUS SCISSORS T.C	100
SUCTION TUBES	49
SURGICAL GLOVES STERILE	145
SYRINGE DISPOSABLE STERILE	145

T

TAYLOR DRESSING / TISSUE FORCEPS	20
TAYLOR PERCUSSION HAMMER	2, 144
TEALE TENACULUM FORCEPS	75
TENACULUM FORCEPS	74
TENATOMY SCISSORS T.C	100
THERMOMETERS	145
THOMAS ALLIS TISSUE FORCEPS	10
THOMAS GAYLOR UTERINE BIOPSY FORCEPS	80
THOMAS UTERINE CURETTE	79
THORACOTOMY RIB SPRADERS MINI	53
THUDICHUM NASAL SPECULUM	39
TIECK HALLE NASAL SPECULUM	38
TISCHLER BABY BIOPSY FORCEPS	82
TISCHLER BIOPSY FORCEPS	82
TISCHLER KEVOKIAN BIOPSY FORCEPS	82
TISSUE FORCEPS	19
TOENNIS NEEDLE HOLDER	25
TONGUE DEPRESSOR	35
TOWEL CLAMP	12
TOYNEBEE EAR SPECULUM	40
TRACHEA RETRACTOR	26
TROUTMAN COLIBRI FORCEPS	87
TUBE FORCEPS	10
TUBE OCCULADING FORCEPS	10
TUFFIER RIB SPRADERS TUFFLIMIRE	53
TUNNING FORK	126
TUNNING FORK SET	51
TUTTLY LASER FORCEPS	143
TYREEL HOOK	111
	26

U

U.S ARMY RETRACTOR	27
U.S UMBILICAL SCISSORS	17
ULRICH COTTON SWAB FORCEPS	11
UNIVERSAL PLIER	139
UNIVERSAL WIRE CUTTER T.C	79
URINAL JUG FEMAIL	114
URINAL JUG MAIL	114
UTILITY SCISSORS	144

V

VAN BUREN SOUND	76
VANNAS SCISSORS	91
VERBRUGGE BONE HOLDING FORCEPS	65
VIENNA DOUBLE BLUNT EYE HOOK	146

INDEX

VIENNA NASAL SPECULUM	39
VIRTUS SPLINTER FORCEPS	22
VOLKMAN BONE CURETTE	60
VOLKMAN RETRACTOR	29
VOLTOLINI NASAL SPECULUM	39

W

WAGENER EAR FORCEPS	45
WALTER SPLINTER FORCEPS	22
WANGENSTEEN FORCEPS T.C	101
WARTENBERG NEUROLOGICAL PIN	2
WHEEL WAX CARVERS	129
WEBSTER NEEDLE HOLDER	23
WECKER SCISSORS	90
WEIL BLAKESLEY RONGUER	56
WEINGART UTILITY PLIER	139
WEITLANER RETRACTOR	32
WESTCOTT TENOTOMY SCISSORS	91
WHEELER SPATULA	85
WHITE TOENAIL SCISSORS	146
WHITEHEAD MOUTH GAG	36
WIENER SKIN HOOK	26
WILLIAM SPLINTER FORCEPS	22
WILLIAMS TISSUE FORCEPS T.C	103
WILLIGER HAMMER	62
WINDOW POUNCHER	145
WINTER BIOPSY FORCEPS	81
WINTER FORCEPS	83
WIRE BENDING PLIER	139
WIRE CUTTING FORCEPS T.C	107
WIRE CUTTING PLIER	72, 73
WIRE HOLDING FORCEPS T.C	107
WIRE MASH TRAY	114
WIRE TWISTING FORCEPS T.C	107
WULLSEEIN CURETTE	47
WULLSTEIN EAR INSTRUMENTS	46

Y

YOUNG TONGUE FORCEPS	35, 144
----------------------	---------



NEWMAX

CORP.

Quality You Can Trust !

 Plot No.191, Near Flyover Kashmir Road
Sialkot 51310 Pakistan

 <https://www.newmax.pk>

 info@newmax.pk

 +92-52-4271639

 +92-316-771-9985

We Deal in all Kind of Surgical & Dental Instruments.



www.newmax.pk